

Jelle 175 Plus
Art. Nr. 2839150
1/6



24.01.2023

Art.Nr. 2839150

Groundplan - Grundplan - Plan de masse - Planimetria - Plattegrond - Põhiplaan

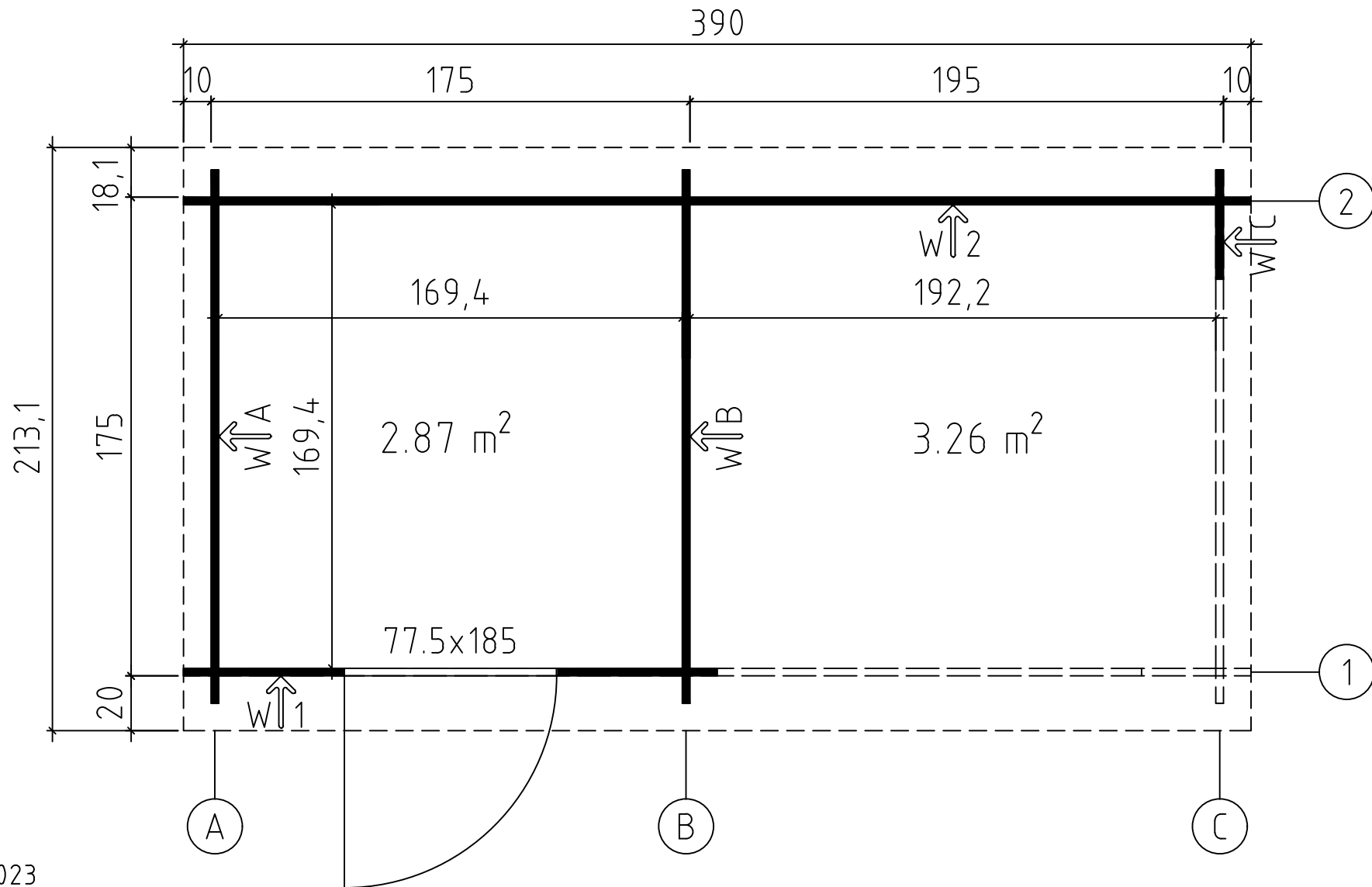



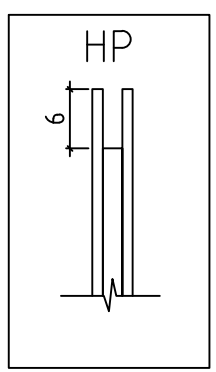
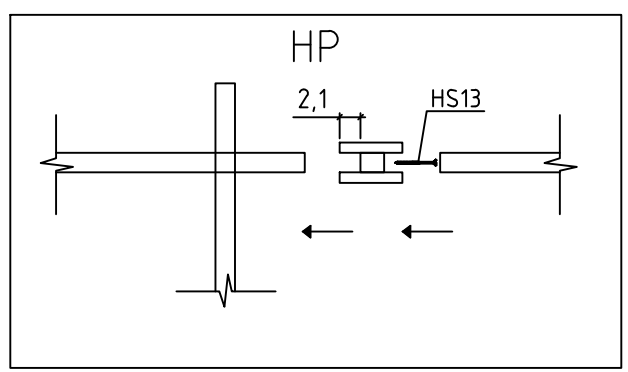
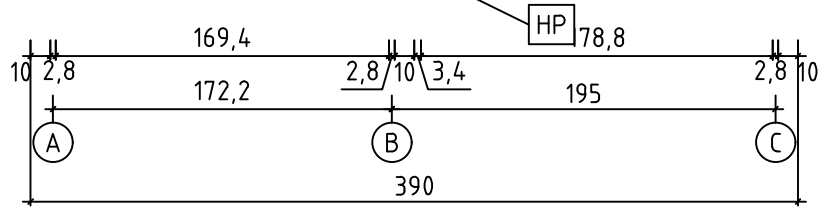
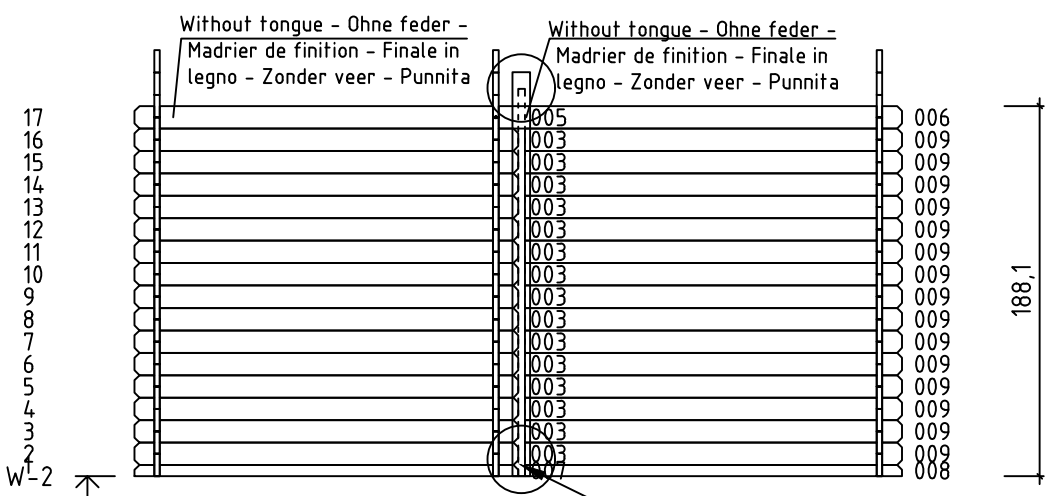
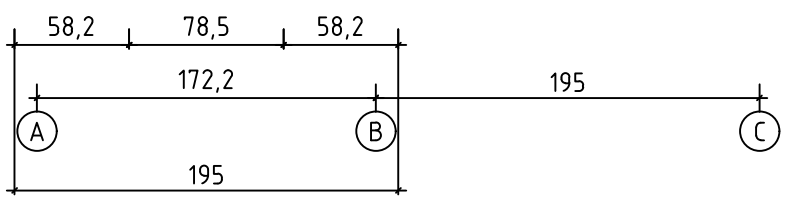
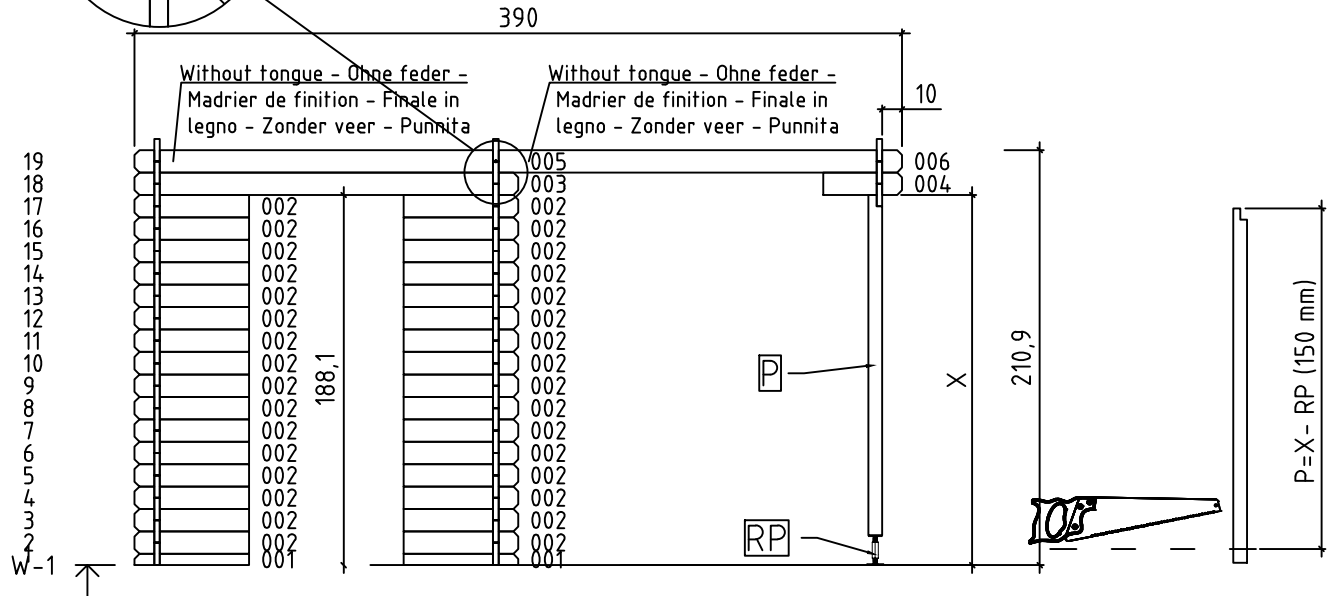
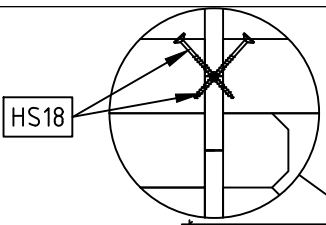



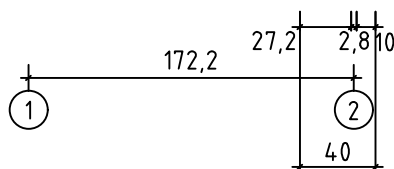
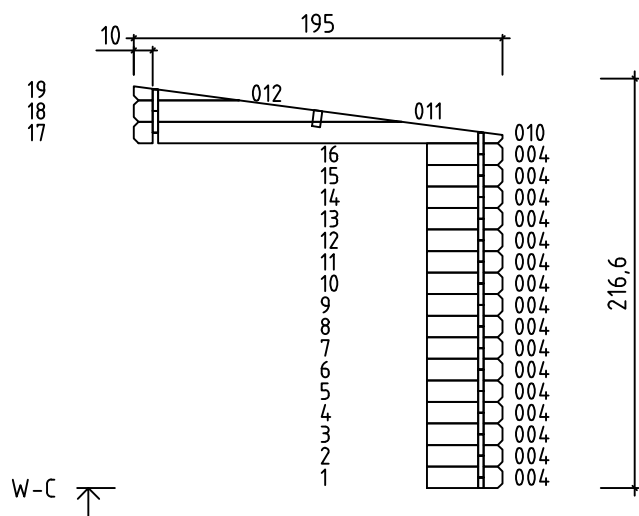
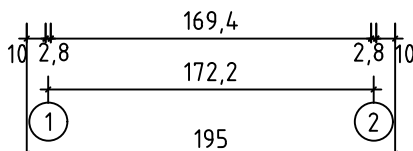
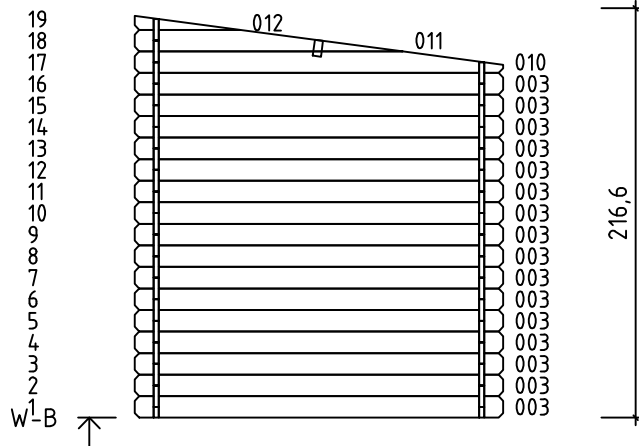
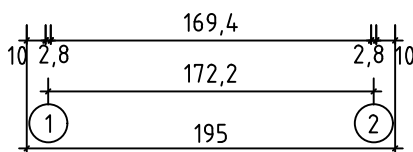
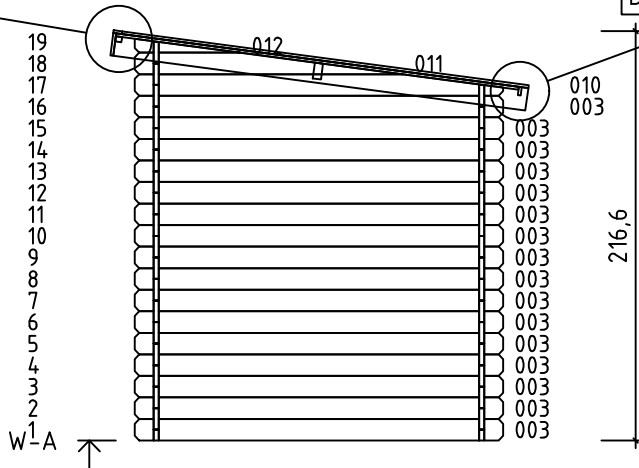
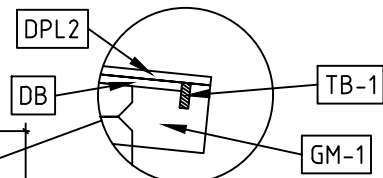
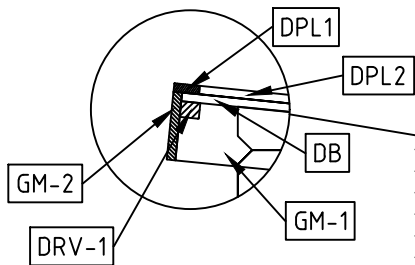

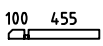
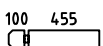
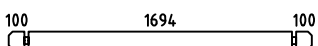

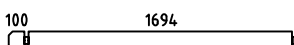
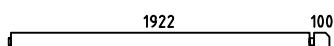
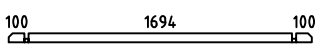
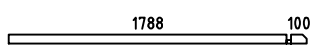
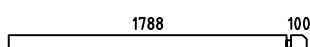
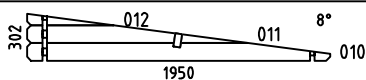
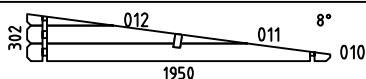
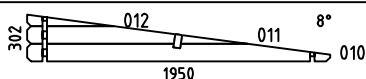
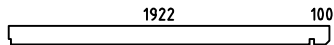
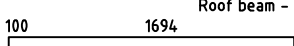
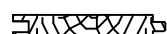
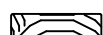

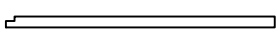
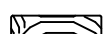

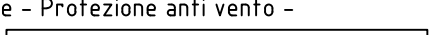

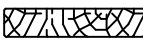
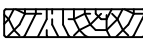
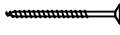
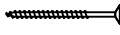
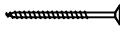

Art.Nr. 2839150

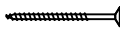
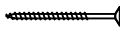
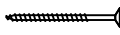
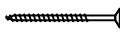
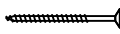



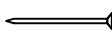
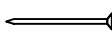

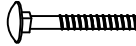
Art.Nr. 2839150

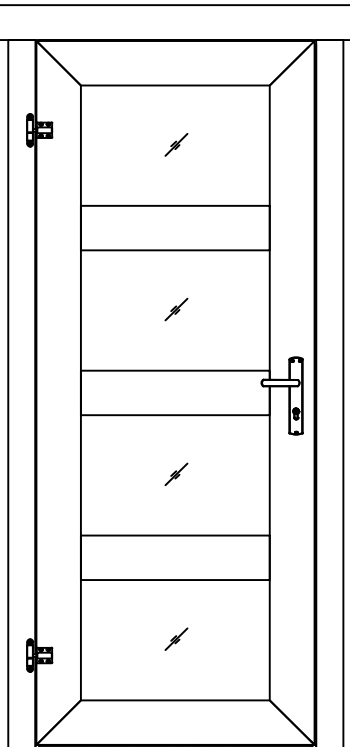
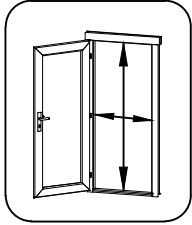

Pos Code	Piece list - Stückliste - Liste des pièces - Elementi - Stuklijst - Tükítabel 24.01.2023 Art.Nr. 2839150 5/6	Q	P (mm)	L (mm)
001 34029		2	28x57	583
002 34031		32	28x114	583
003 34032		48	28x114	1950
004 29851		17	28x114	400
005 34033		2	28x114	1836
006 34034		2	28x114	2064
007 34035		1	28x57	1950
008 34036		1	28x57	1916
009 34037		15	28x114	1916
WA-1 34038		1		
WB-1 34038		1		
WC-1 34038		1		
A-PR2 34042	Roof beam - Dachbalken - Panne de toit - Perlina del tetto - Gordingen / dakbalk - Pärтин 	1	44x120	2064
A-PR1 34043	Roof beam - Dachbalken - Panne de toit - Perlina del tetto - Gordingen / dakbalk - Pärтин 	1	44x120	1836
DB 18996	Roof boards - Dachbretter - Voliges - Perlina per tetto - Dakhout - Katuselaud 	44	90x15	2150
DPL2 34045	Roofing felt fillet - Dachpappenleiste - Baguette de fixation du feutre bitumeux - Asse per fissaggio guaina bituminosa - Afdekljst asfaltpapier - Katusepapiliist 	2	15x45	2170
DPL1 34044	Roofing felt fillet - Dachpappenleiste - Baguette de fixation du feutre bitumeux - Asse per fissaggio guaina bituminosa - Afdekljst asfaltpapier - Katusepapiliist 	2	15x45	1965
DPP-1	Roofing felt (strip) - Dachpappe (bahnen) - Feutre bitumeux (bande) - Cartone catramato - Asfaltpapier (baan) - Katusepapp 	3		4000
P 37557	Post - Pfosten - Poteau - Piede registrabile - Stijl - Post 	1	70x70	1782
TB-1 33326	Fascia board - Traufbrett - Bandeau de toit - Finitura lati tetto - Gevellijst - Räästalaud 	2	15x45	1950
27597	H-profile - H-profils - Profile h - Profilo ad h - H-profiel - H-profiil 	1	90x58	1820
DRV-2 19886	Roof edge reinforcement - Dachrandverstärkung - Corniere de renfort de bord de toit - Rinforzo x tetto - Dakrand versterking - Räästatugevdus 	2	28x34	1950
KFS-1 2249	Storm protection - Sturmleiste - Latte anti-tempete - Protezione anti vento - Stormverankering / beveiliging - Tormikinnitusliist 	5	22x45	2050

Pos Code	Piece list - Stückliste - Liste des pièces - Elementi - Stuklijst - Tükítabel 24.01.2023 Art.Nr. 2839150 6/6	Q	P (mm)	L (mm)
34047	U-profile - U-profils - Profile u - Profilo ad u - U-profiel - U-profiil 	1	28x58	1726
GM-1 34049	Gable moulding - Giebelleiste - Planche de rive - Finitura per frontale e retro del tetto - Gevellijst - Viilulaud 	2	15x120	2215
GM-2 34048	Gable moulding - Giebelleiste - Planche de rive - Finitura per frontale e retro del tetto - Gevellijst - Viilulaud 	2	15x120	1950
HS9 5106	Screw for u-profile - Schraube zur befestigung u-profils - Vis a tete fraisée pour profil u - Vite per profilo ad u - Schroef ter bevestiging u-profiel - Kruvi U-profiilile 	5	3.5x50	
HS9 5106	Screw for gable moulding - Schrauben für giebelleiste - Vis pour fixation planche de rive - Vite per fissare finiture davanti e dietro del tetto - Schroef voor gevellijst - Kruvi viilulauale 	12	3.5x50	
HS4 5102	Screw for fascia boards - Schrauben für traufbretter - Vis pour fixation bandeau de toit - Viti x striscia del tetto - Schroef voor gevellijst - Kruvi räästalauale 	9	3x30	
HS12 5109	Screw for roof edge reinforcement - Schrauben für dachrandverstärkung - Vis pour fixation corniere renfort de bord de toit - Viti x rinforzo bordo tetto - Schroef voor dakrand versterking - Kruvi räästatugevdusele 	9	4x40	
HS12 5109	Screw for gable moulding - Schrauben für giebelleiste - Vis pour fixation planche de rive - Vite per fissare finiture davanti e dietro del tetto - Schroef voor gevellijst - Kruvi viilulauale 	9	4x40	
HS13 5110	Screw for h-profile - Schraube zur befestigung h-profils - Vis a tete fraisée pour profil h - Vite per profilo ad h - Schroef ter bevestiging h-profiel - Kruvi H-profiilile 	1	4x60	
HS13 5110	Screw for post - Schrauben für pfosten - Vis de fixation des poteaux - Viti per inviare - Schroef voor stijlen - Kruvi postile 	2	4x60	
HS18 5113	Screw for roof beams - Schrauben für dachbalken - Vis pour fixation pannes de toit - Viti per perline del tetto - Schroef voor gordingen / dakbalken - Kruvi pärlinitele 	4	5x120	
HS18 5113	Screw for gable - Schrauben für giebel - Vis pour fixation des pignons - Viti per timpano - Schroef voor gevelpunt - Kruvi viilude kinnitamiseks 	6	5x120	
HS20 5118	Screw for post height adjustment - Schrauben für regulierungsschraube für pfosten - Vis de fixation de support réglable de poteau - Viti per fissare ed aggiustare l'altezza del palo verticale - Schroef voor hoogte instelling stijlen - Kruvi vajumispolidile 	8	6x50	
SH28 32509	Hammer block - Schlagholz - Calle de frappe - Blocco di legno da usare come cuscinetto quando si usa il martello - Slagklos - Löögiklots 	1		
SFS 5133	Nut for storm protection - Schraubenmutter für sturmleiste - Ecrou pour latte anti-tempete - Dado x asta protezione vento - Moer voor stromverankering - Mutter tormikinnitusliistule 	10	D6	
NF4 5137	Zn nail for roof - Zn nagel für dachbretter - Pointe pour fixation voliges de toit - Chiodi x perline tetto - Spijker(nagel) voor dakhout - Nael katuselauale 	141	2x50	
NF5 5145	Zn nail for roofing felt fillet - Zn nagel für dachpappenleiste - Pointe pour baguette de fixation feutre bitumeux - Chiodi x carta bituminosa x tetto - Spijker(nagel) voor asfaltpapier afdeklijst - Papiliistunael 	17	2x40	
NF6 21567	Roofing nails for roofing felt - Nägel für dachpappe - Pointe pour fixation feutre bitumeux - Chiodi per cartone catramato - Asfaltnagel - Papinael 	108	2.8x15	
BFS 5155	Bolt for storm protection - Bolzen für sturmleiste - Boulon pour latte anti-tempete - Bullone x asta protezione vento - Bout voor stormankerlat - Puidupolt tormikinnitusliistule 	10	6x60	
DFS 5125	Washer for storm protection - Dichtscheibe für sturmleiste - Rondelle pour latte anti-tempete - Rondella x asta protezione vento - Afdichtring voor storm strip - Seib tormikinnitusliistule 	10	D6	
34582	Post height adjustment - Regulierungsschraube für pfosten - Support réglable de poteau - Piede registrabile in altezza - Stelschroef voor stijlpot - Vajumispoltt 	1	D20	
34053	Door - Tür - Porte - Porte - Deur - Uks 775x1850 UK.4.020.SVV.MMX28 SGA+28	1		

Pos	15.01.2018 Piece list - Stückliste - Liste des pièces - Elementi - Stuklijst - Tükítabel 775x1850 UK.4.020.SVV.MMX28 SGA+28	1/2	Q	P (mm)	L (mm)
	<p data-bbox="263 152 1284 183">Glass size - Glasgröße - Taille de la vitre - Misura del vetro - Glas afmeting - Klaasi mõõt: 502x325 mm</p> <div data-bbox="678 241 1029 985" style="text-align: center;">  </div> <div data-bbox="1332 152 1524 376" style="text-align: center;">  <p data-bbox="1364 398 1492 430">702x1793 mm</p> </div>				
1	Upper door jamb - Türrahmen oben - Cadre de porte supérieur - Telaio superiore della porta - Bovendorpel - Ukse ülemine leng		1	66x100	912
2	Left door jamb - Türrahmen links - Cadre de porte gauche - Telaio montante sinistro della porta - Linkerstijl deurframe - Ukse vasak leng		1	66x80	1850
3	Right door jamb - Türrahmen rechts - Cadre de porte droit - Telaio montante destro della porta - Rechterstijl deurframe - Ukse parem leng		1	66x80	1850
4	Doorstep - Swelle - Barre de seuil - Soglia della porta - Deurdorpel - Lävepak		1	20x21	702

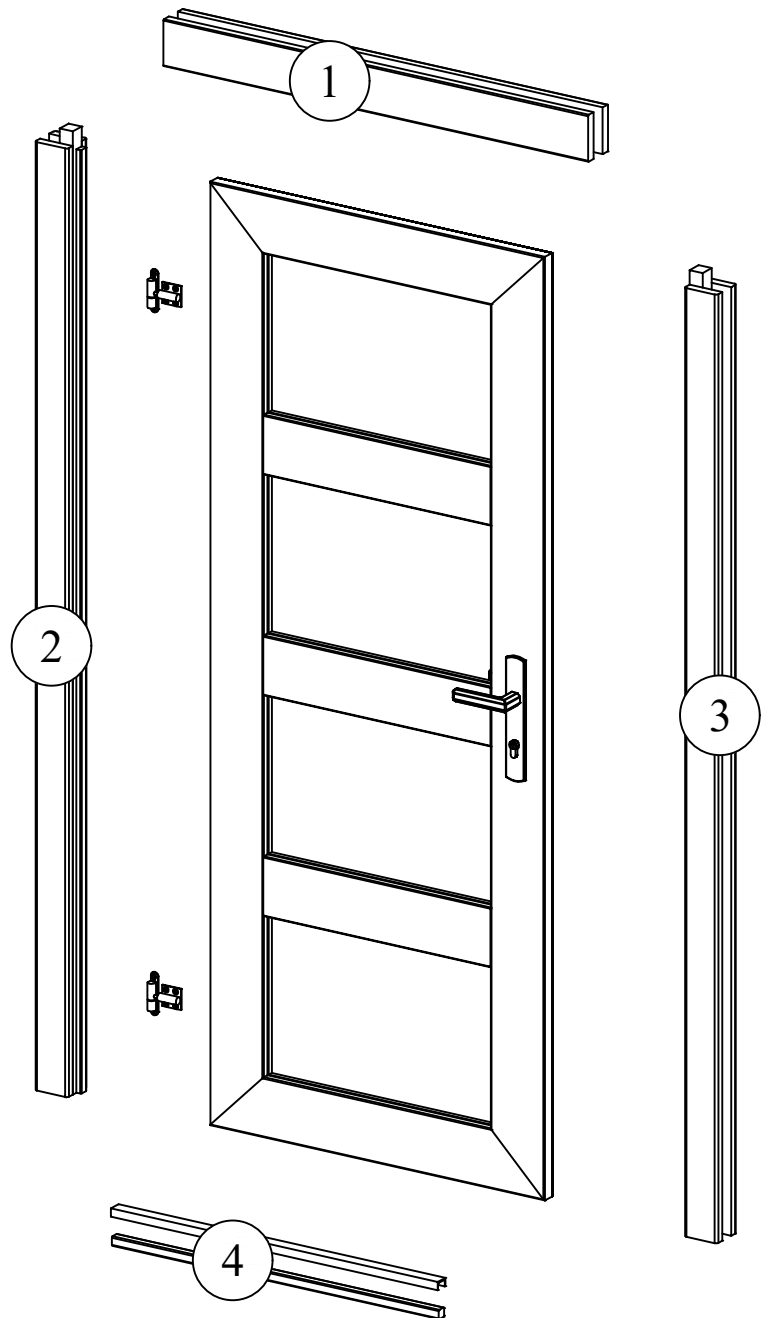

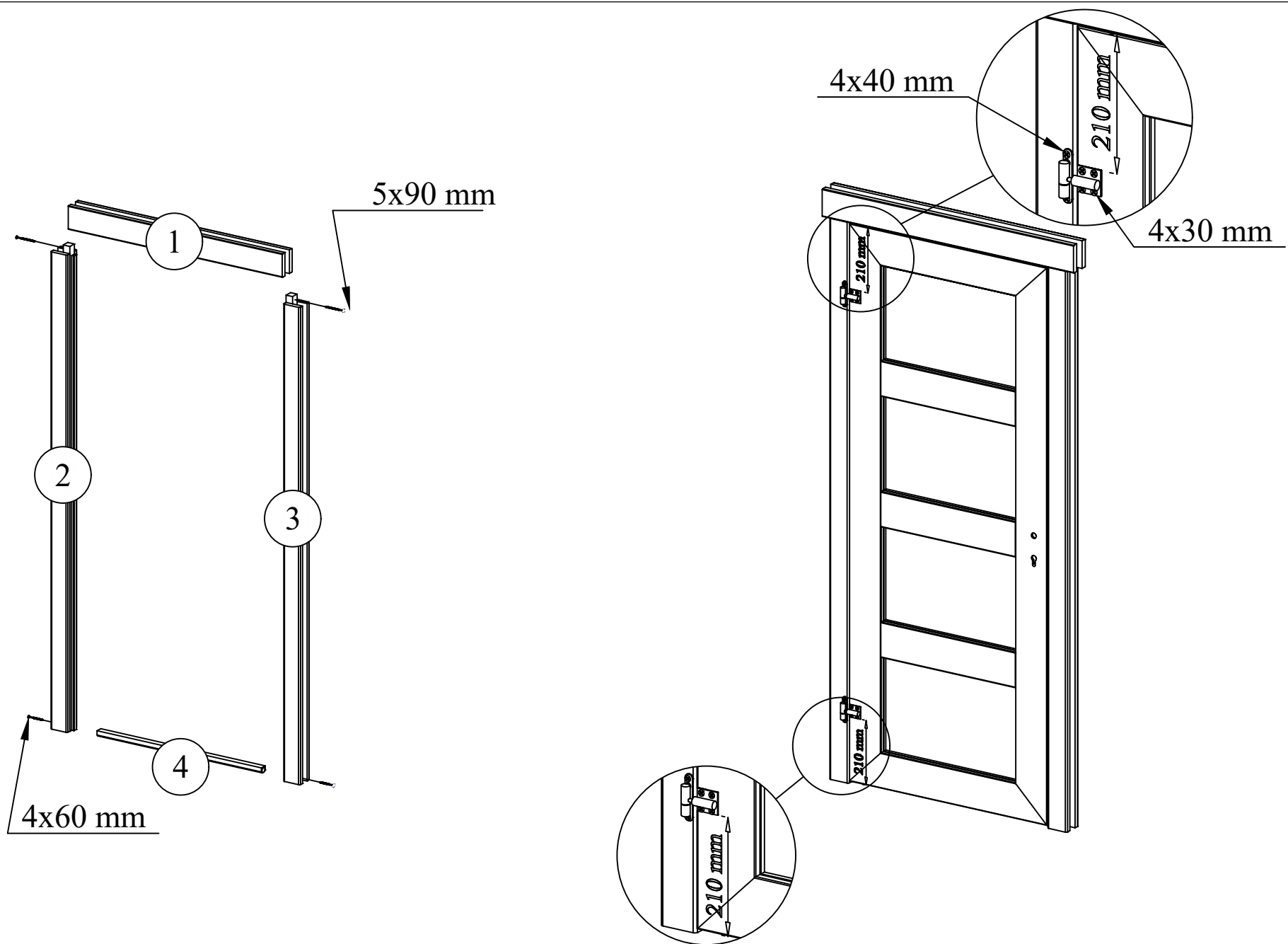

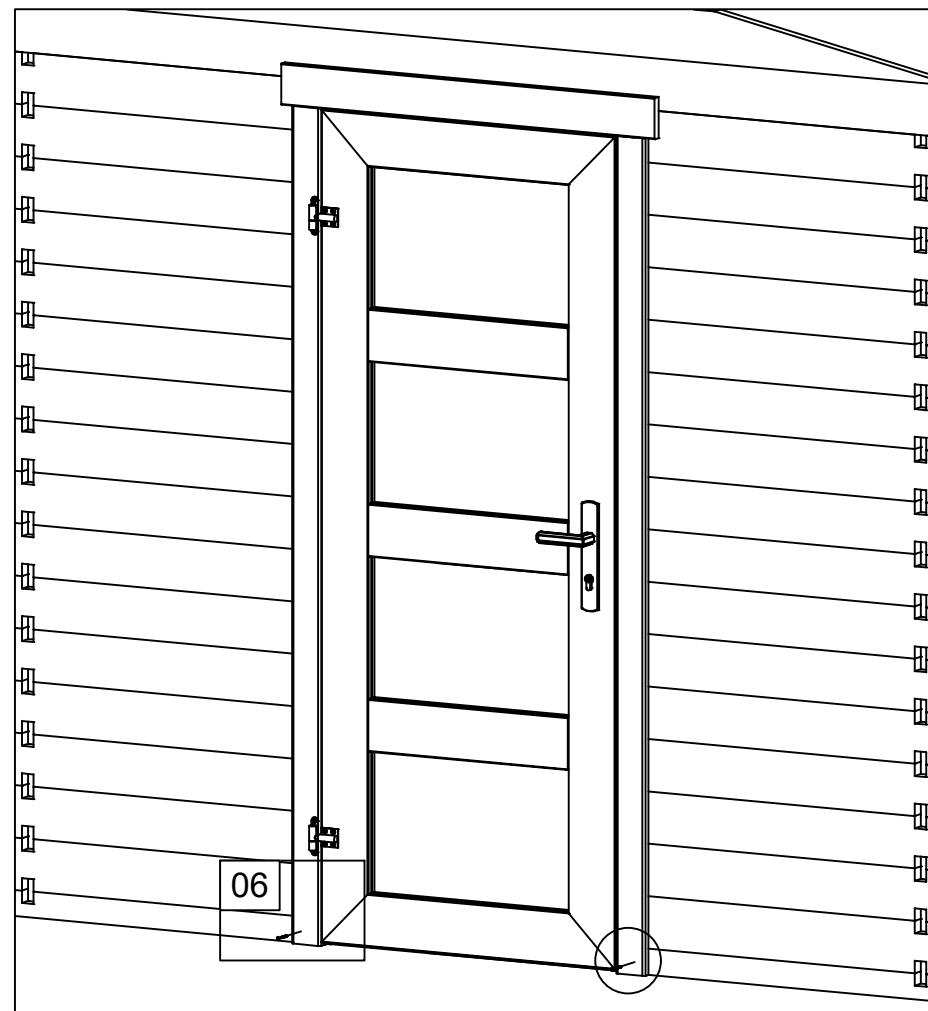
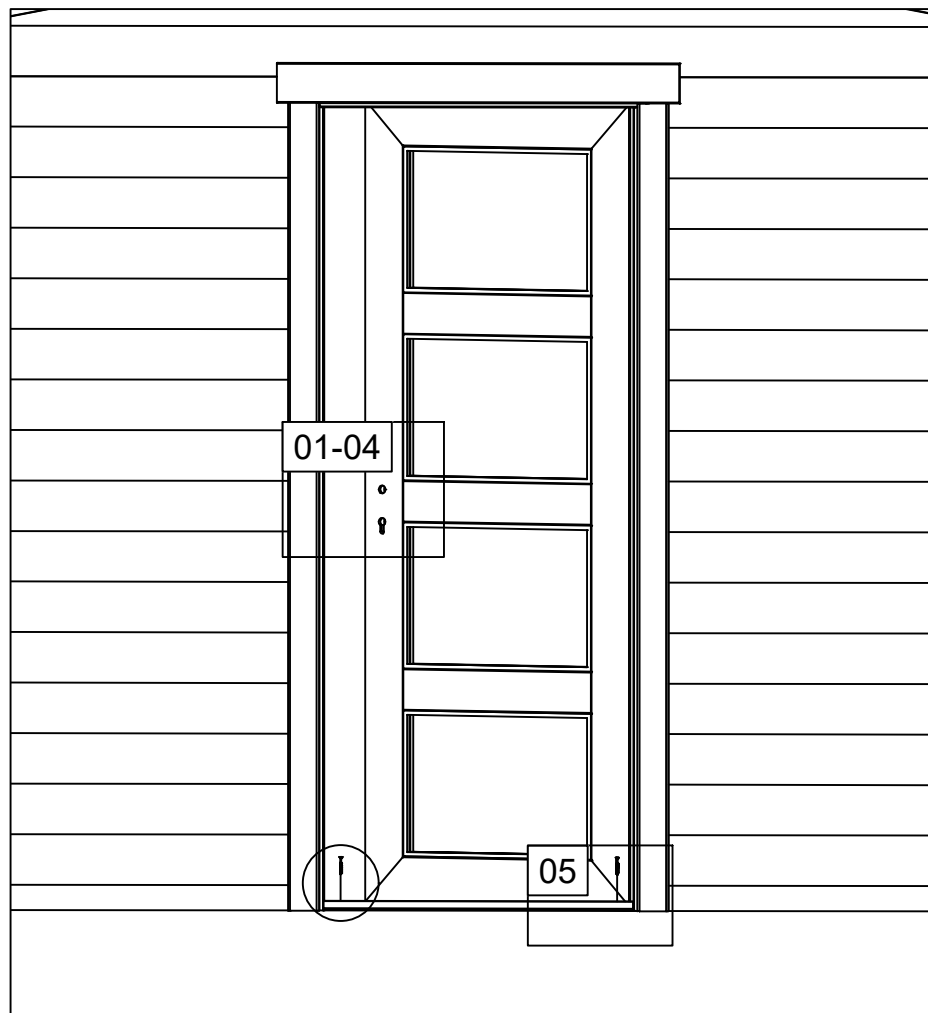

01

4x25 mm

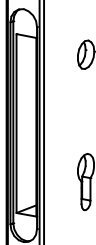
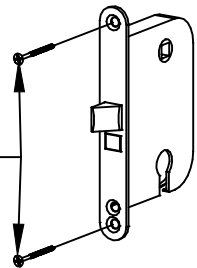

04

4x25 mm

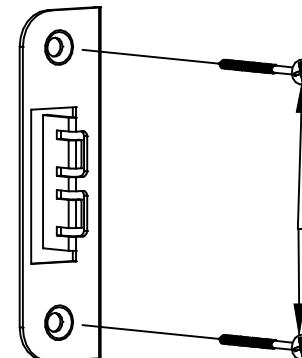

02

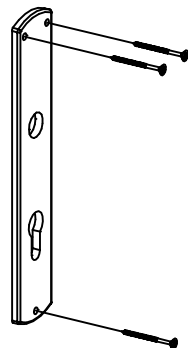
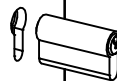
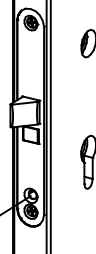
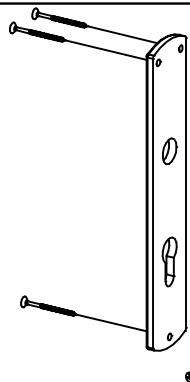

05

4.5x60 mm

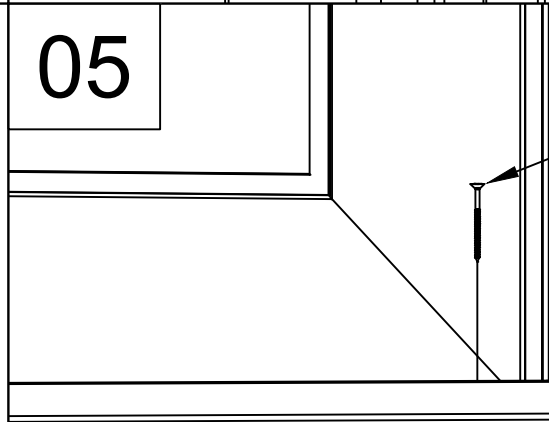

03

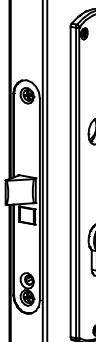
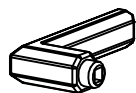

06

3.5x50 mm

