

Art. Nr. 2853500

1/21

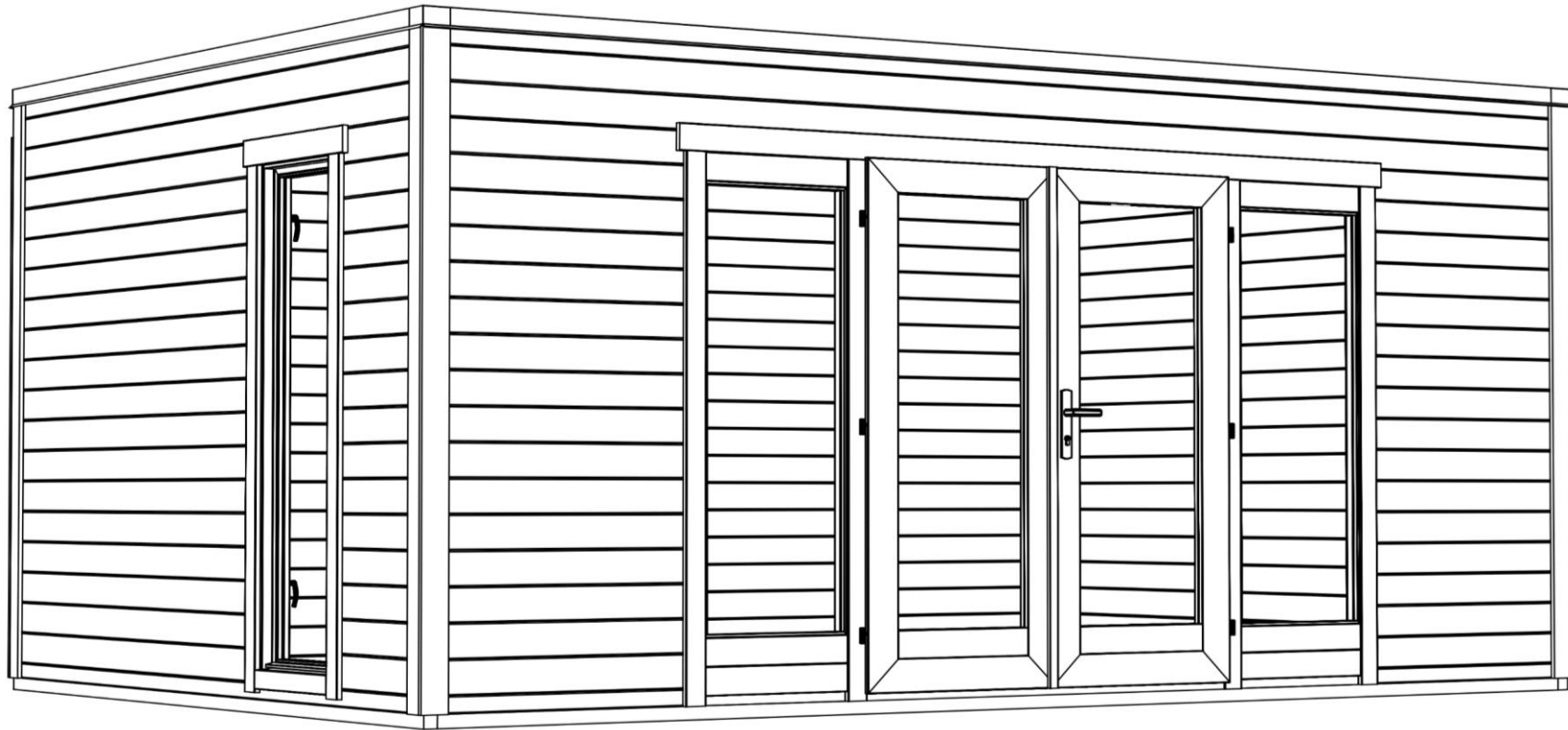

17.01.2023

Art. Nr. 2853500

Groundplan - Grundplan - Plan de masse -
Planimetria - Plattegrond - Põhiplaan

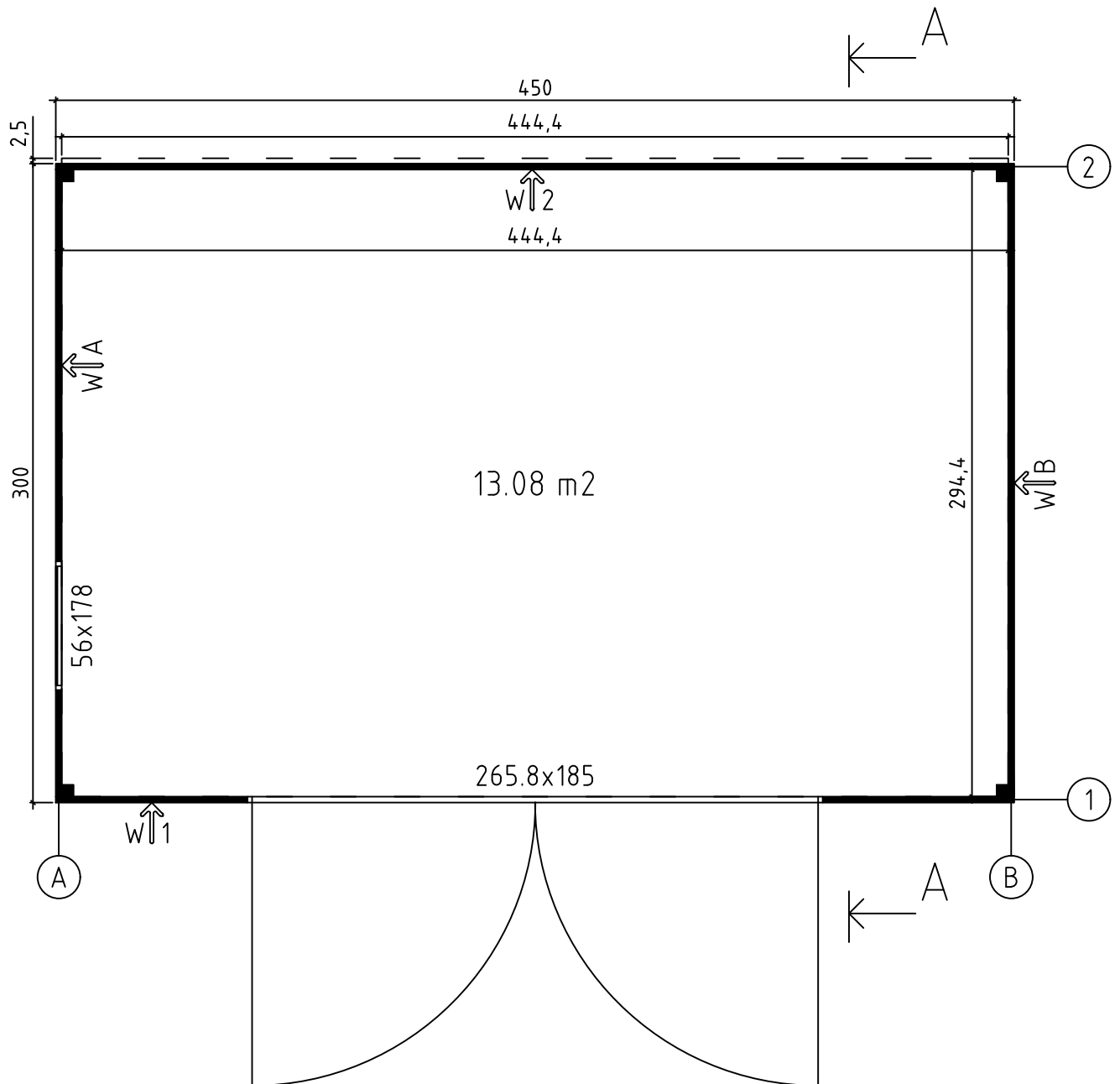

Art. Nr. 2853500

Foundation - Fundament - Fondation -
Fondamenta - Fundering - Immutatud alusraam

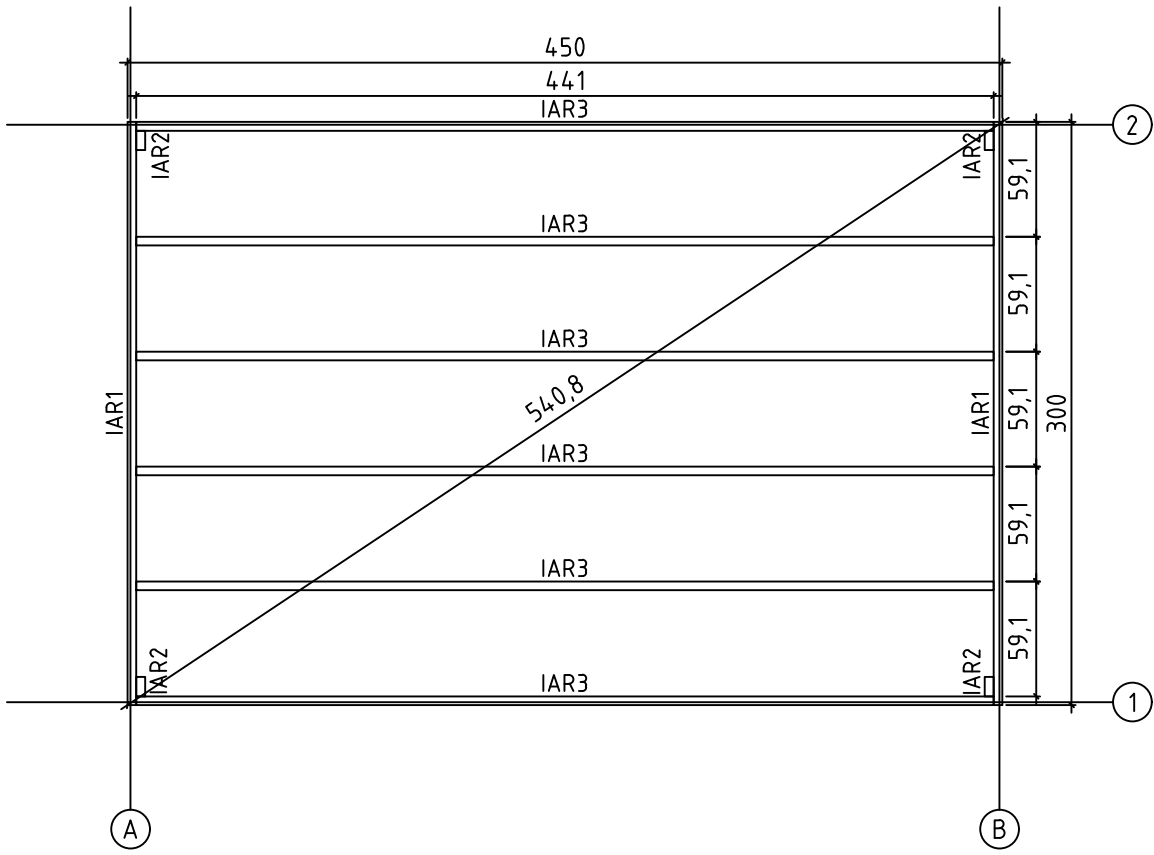

Floor boards - Fussbodenbretter - Plan pose plancher -
Pavimento - Vloerhout - Põrandalaudis

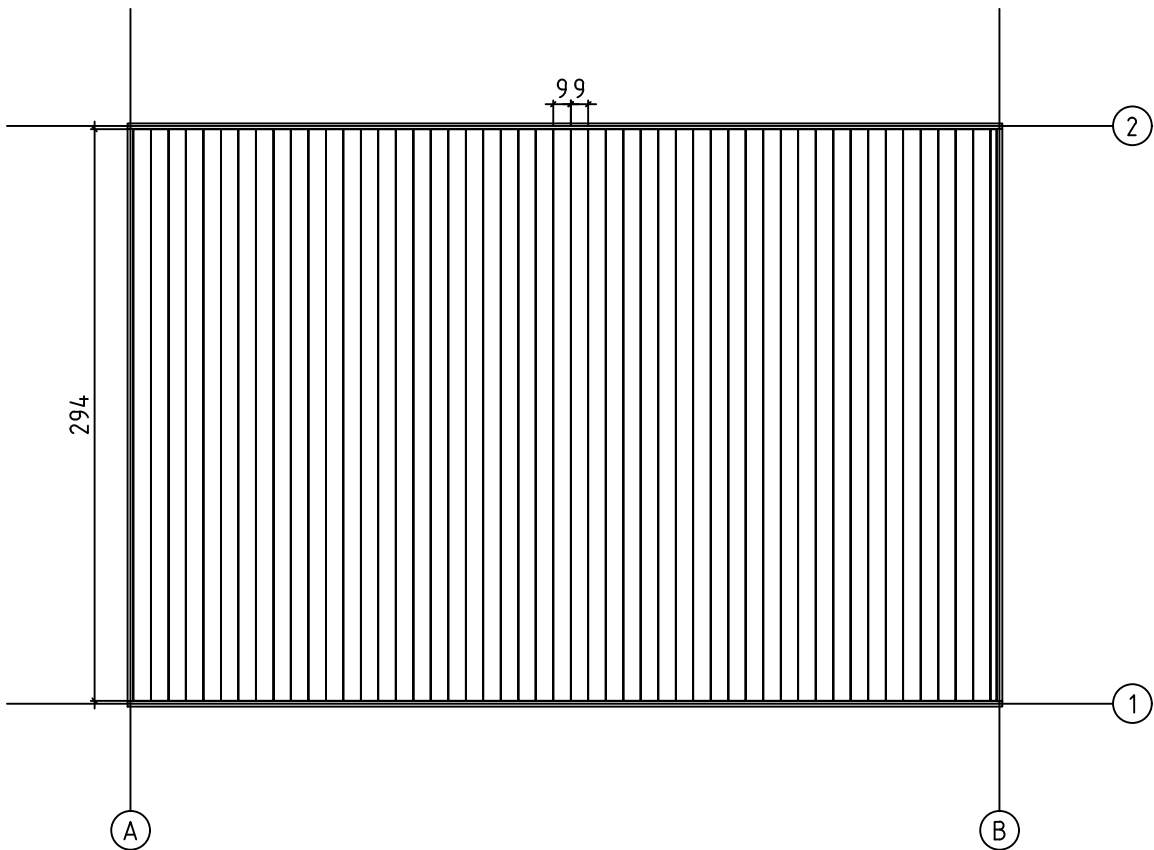

Art. Nr. 2853500



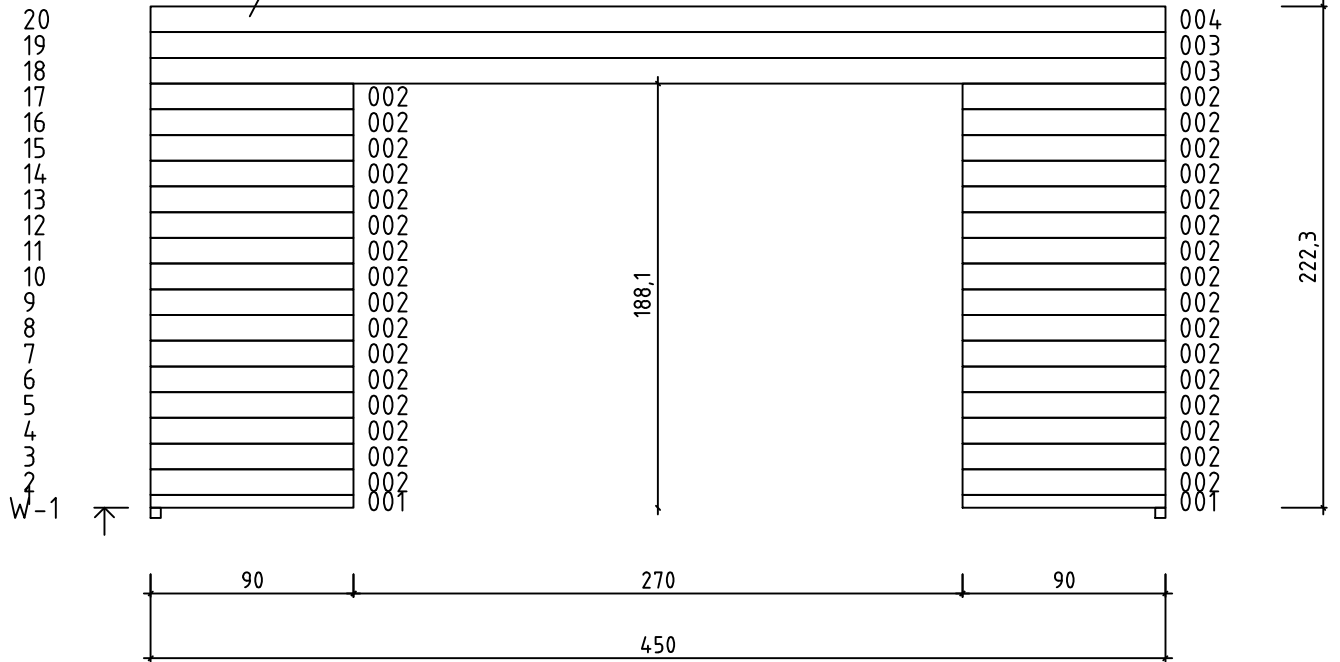



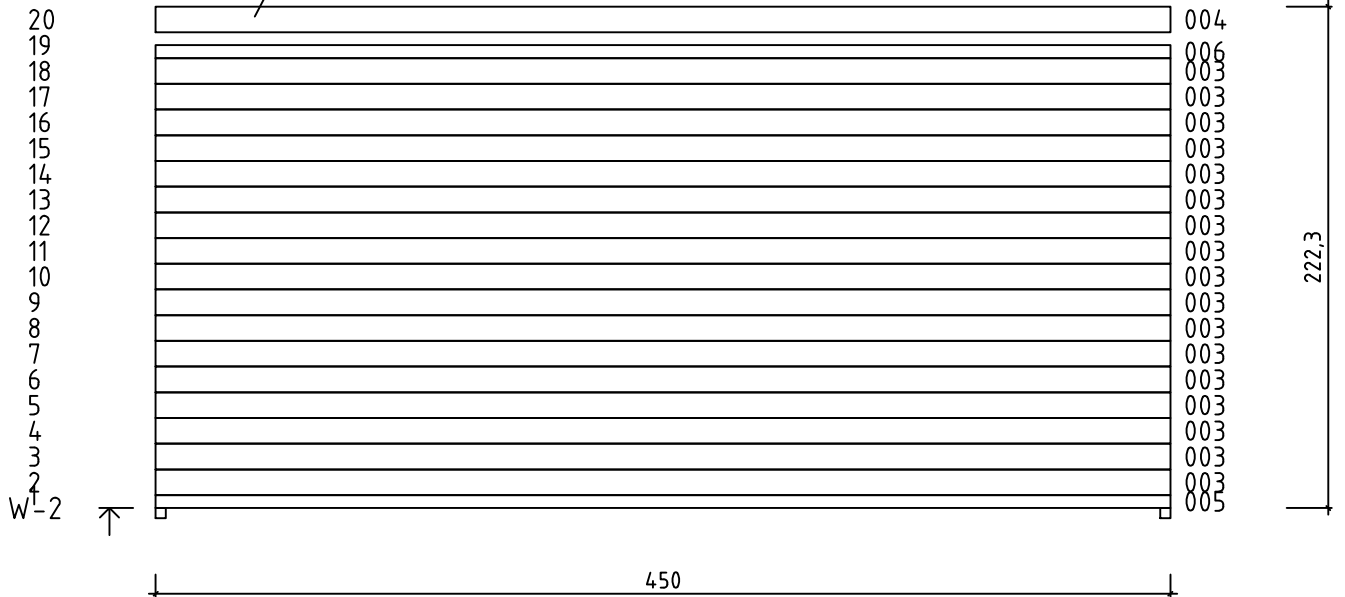

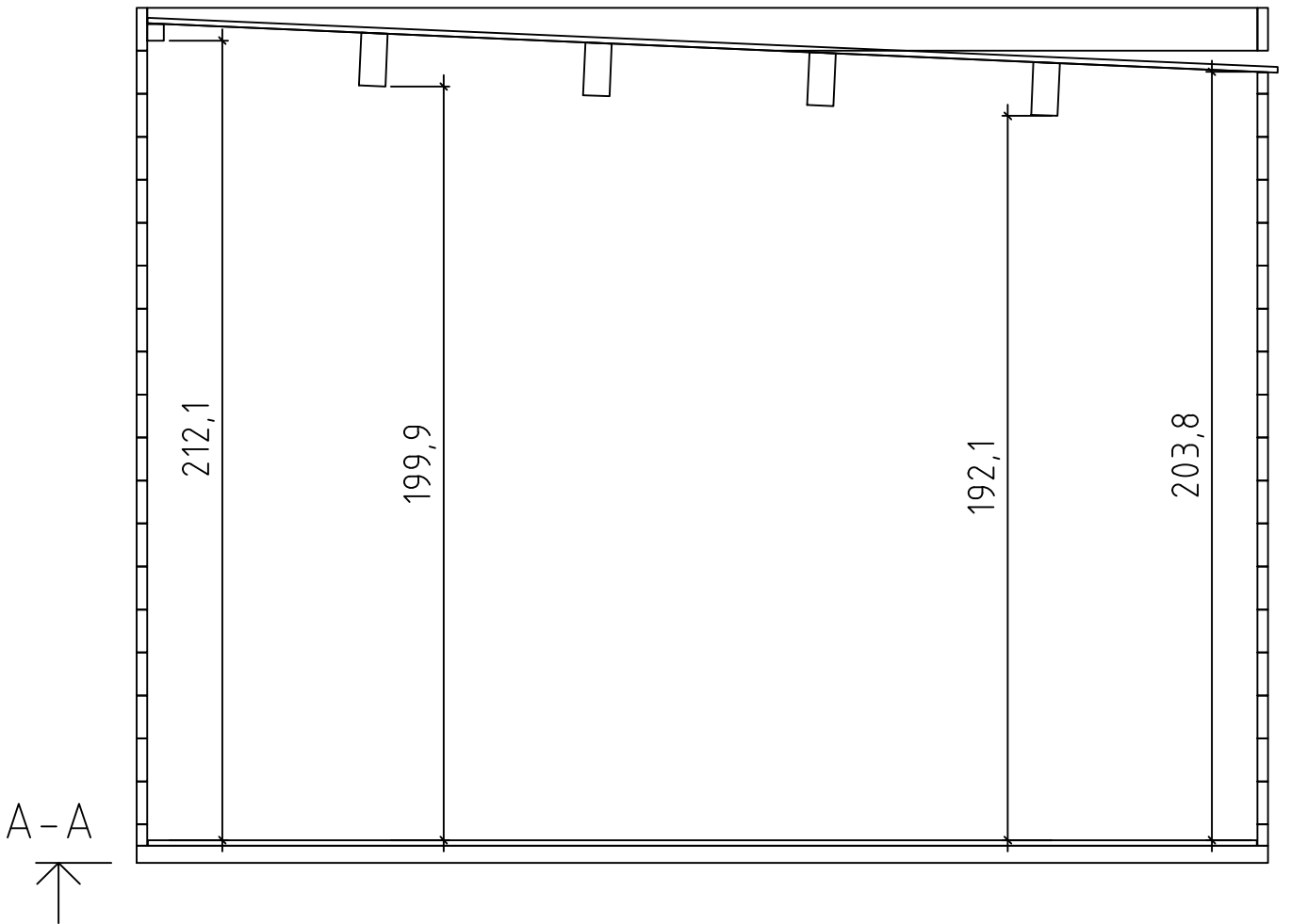

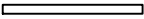

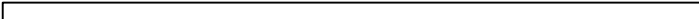

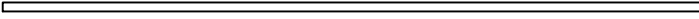
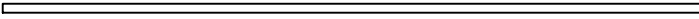

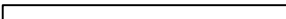
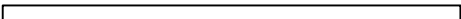
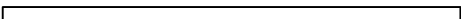
Without tongue - Ohne feder - Madrier de finition -
Finale in legno - Zonder veer - Punnita

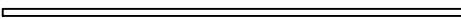

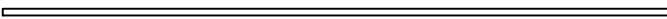

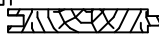
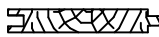



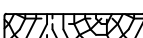

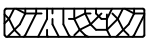







Without tongue - Ohne feder - Madrier de finition -
Finale in legno - Zonder veer - Punnita



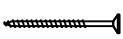

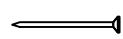
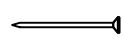
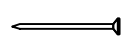
Pos	17.01.2023 Piece list - Stückliste - Liste des pièces - Elementi - Stuklijst - Tükitalbel Art. Nr. 2853500 7/21	Q	P (mm)	L (mm)
001 44715		2	28x57	900
002 44716		32	28x114	900
003 44717		19	28x114	4500
004 44718		2	28x114	4500
005 44722		1	28x57	4500
006 44719		1	28x57	4500
007 23530		2	28x57	2944
008 5690		16	28x114	500
009 41073		16	28x114	1840
010 18093		20	28x114	2944
011 44379		2	28x114	2944
IAR3 26160	Foundation - Fundament - Fondation - Fondamenta - Fundering - Immutatud alusraam 	6	45x45	4410
IAR1 21752	Foundation - Fundament - Fondation - Fondamenta - Fundering - Immutatud alusraam 	2	45x45	3000
IAR2 44380	Foundation - Fundament - Fondation - Fondamenta - Fundering - Immutatud alusraam 	4	45x45	100
RV1 44720	Lath - Pfetten - Liteau - Piccola asse - Gordingen - Roov 	1	44x44	4334
A-PR1 44721	Roof beam - Dachbalken - Panne de toit - Perlina del tetto - Gordingen / dakbalk - Pärilin 	4	70x140	4436
FB 23056	Floor boards - Fussbodenbretter - Lame de plancher - Pavimento - Vloerhout - Põrandalaud 	50	90x15	2940
RB 33576	Roof boards - Dachbretter - Voliges - Perlina per tetto - Dakhout - Katuselaud 	50	90x15	3000
30087	Floor fillet - Fussbodenteiste - Corniere de finition du plancher - Finitura per pavimento (battisco pa) - Vloerafwerklijst - Põrandaliist 		18x18	16
P1 44712	Post - Pfosten - Poteau - Piede registrabile - Stijl - Post 	2	55x55	2050
P2 44713	Post - Pfosten - Poteau - Piede registrabile - Stijl - Post 	2	55x55	2180
CF1 41635	Corner fillet - Deckleiste - Profils de finition angles a l'exterieur - Massello d'angolo - (hoek)lijst - Nurgaliist 	4	15x70	2223
CF2 23609	Corner fillet - Deckleiste - Profils de finition angles a l'exterieur - Massello d'angolo - (hoek)lijst - Nurgaliist 	2	15x90	2052

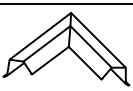
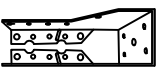
Pos	17.01.2023 Piece list - Stückliste - Liste des pièces - Elementi - Stuklijst - Tükítabel Art. Nr. 2853500 8/21	Q	P (mm)	L (mm)
CF3 44711	Corner fillet - Deckleiste - Profils de finition angles a l'exterieur - Massello d'angolo - (hoek)lijst - Nurgaliist 	2	15x90	2223
44292	Fascia sheet - Abschlussprofil - Profil de finition métallique pour débord de toiture - Scossalina di protezione dall'acqua per bordo di legno - Afdek profiel / boordprofiel - Räästaplekk 	4		2200
44727	Fascia sheet - Abschlussprofil - Profil de finition métallique pour débord de toiture - Scossalina di protezione dall'acqua per bordo di legno - Afdek profiel / boordprofiel - Räästaplekk 	2		2900
FF1 43853	Fixing fillet - Fixierungsleiste - Profil de fixation - Massello di fissaggio - Bevestiging lijstwerk - Tenderliist 	2	18x28	1800
FF2 23522	Fixing fillet - Fixierungsleiste - Profil de fixation - Massello di fissaggio - Bevestiging lijstwerk - Tenderliist 	2	18x28	1850
HS4 5102	Screw for corner fillet - Schraube zur befestigung deckleiste - Vis pour profils de finition angles a l'exterieur - Viti per massellino d'angolo - Schroef voor afdekljst (hoek) - Kruvi nurgaliistule 	40	3x30	
HS12 5109	Screw for beam holder - Schrauben für balkenhalter - Vis de fixation support "u" galvanisé - Vite per trave di sostegno - Schroef voor bevestiging balkhouder (gordingschoen) - Kruvi talakingale 	48	4x40	
HS12 5109	Screw for fixing fillet of door and window - Schrauben für fixierungsleiste - Vis pour profil vertical de fixation pour ouvertures des fenetres et portes - Viti per massello di fissaggio - Schroeven voor bevestiging van deur en raam lijsten - Kruvi tenderliistufudele 	66	4x40	
HS13 5110	Screw for wall details - Schraube für wand details - Vis pour mur details - Viti per elementi della porta - Schroef voor wand details - Kruvi seinadetailile 	320	4x60	
HS27	Screw for roof lath - Schraube für dachlatte - Vis pour latte - Vite per listello del tetto - Schroef voor daklat - Kruvi roovile 	8	5x70	
HS16 5115	Screw for 1. wall beam - Schraube für 1. bohlenreihe - Vis de fixations 1ere rangée de madriers avec poutrelles de fondations - Vite fissaggio alle fondamenta - Schroef voor 1 wandbalk - Kruvi poollauale 	17	5x90	
HS16 5115	Screw for foundation - Schrauben zur befestigung fundament - Vis de fixations des poutrelles de fondations - Viti x fondamenta - Schroef voor fundering - Kruvi alusraamile 	16	5x90	
HS23 5121	Screw for wall details - Schraube für wand details - Vis pour mur details - Viti per elementi della porta - Schroef voor wand details - Kruvi seinadetailidele 	13	6x180	
HS29	Screw for beam holder - Schrauben für balkenhalter - Vis de fixation support "u" galvanisé - Vite per trave di sostegno - Schroef voor bevestiging balkhouder (gordingschoen) - Kruvi talakingale 	96	5x25	
NF2 5127	Zn nail for floor fillet - Zn nagel für fussbodenleiste - Pointe pour corniere de finition du plancher - Chiodi x fissaggio pavimento - Spijker(nagel) voor vloer afdekljst - Nael põrandaliistule 	32	1.4x40	
NF4 5137	Zn nail for roof - Zn nagel für dachbretter - Pointe pour fixation voliges de toit - Chiodi x perline tetto - Spijker(nagel) voor dakhout - Nael katuselauale 	310	2x50	
NF4 5137	Zn nail for floor - Zn nagel für fussbodenbretter - Clous pour plancher - Chiodi x perline pavimento - Spijker(nagel) voor vloer - Nael põrandalauale 	310	2x50	
HS28 38555	Screw for fascia sheet - Schraube für blende vis pour fascia - vite per lamiera frontale - Schroef voor boeiplaat - Kruvi räästaplekile 	60	4.8x32	
44397	Fascia sheet corner - Eckprofil - Profil d'habillage de rives - Scossalina di protezione dall'acqua per angolo di borbo in legno - Hoekprofiel - Räästapleki 	4		
BM 31254	Beam holder - Balkenhalter - Support en u galvanisé - Supporto della trave Balkendrager (gording schoen) - Talaking 	8	70x125	
43186	Window - Fenster - Fenetre - Finestra - Raam - Aken 560x1780 AK.1.100.SSV SGC	1		
43648	Door - Tür - Porte - Porte - Deur - Uks 2658x1850 3UK.1.100.SVP.M SGC	1		

Art. Nr. 2853500

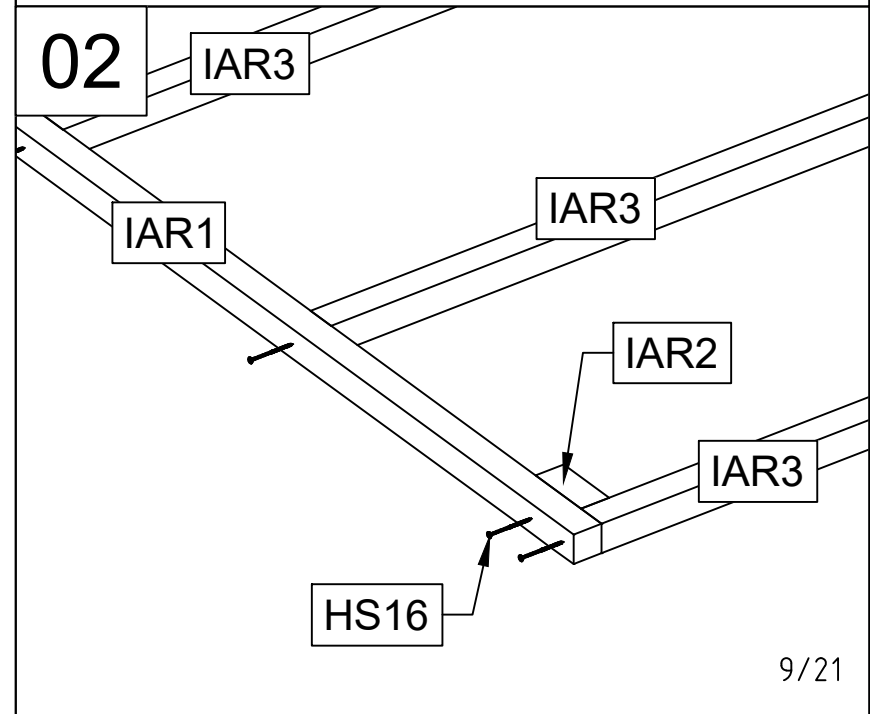
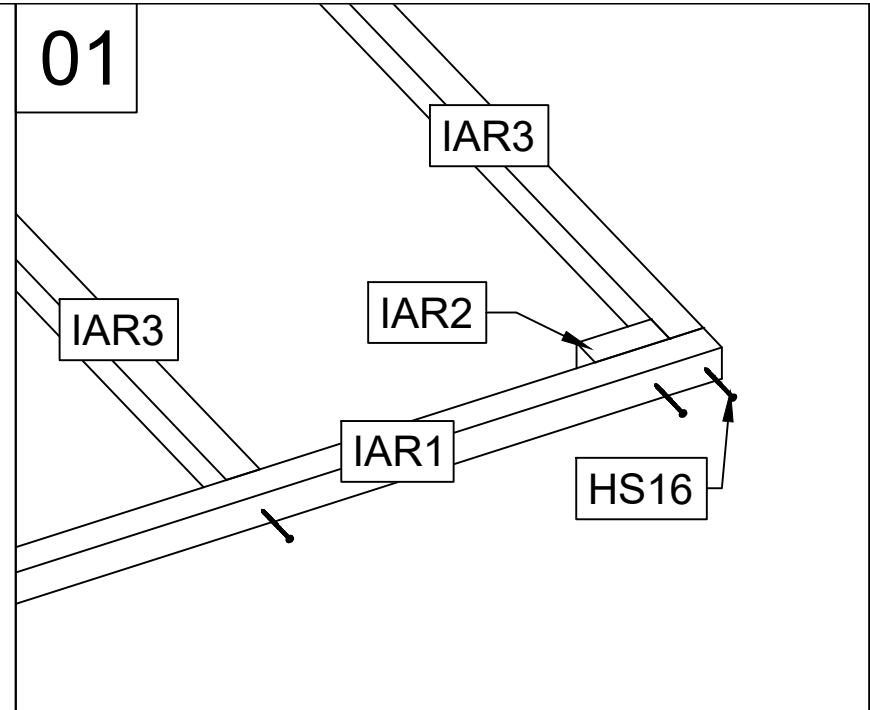
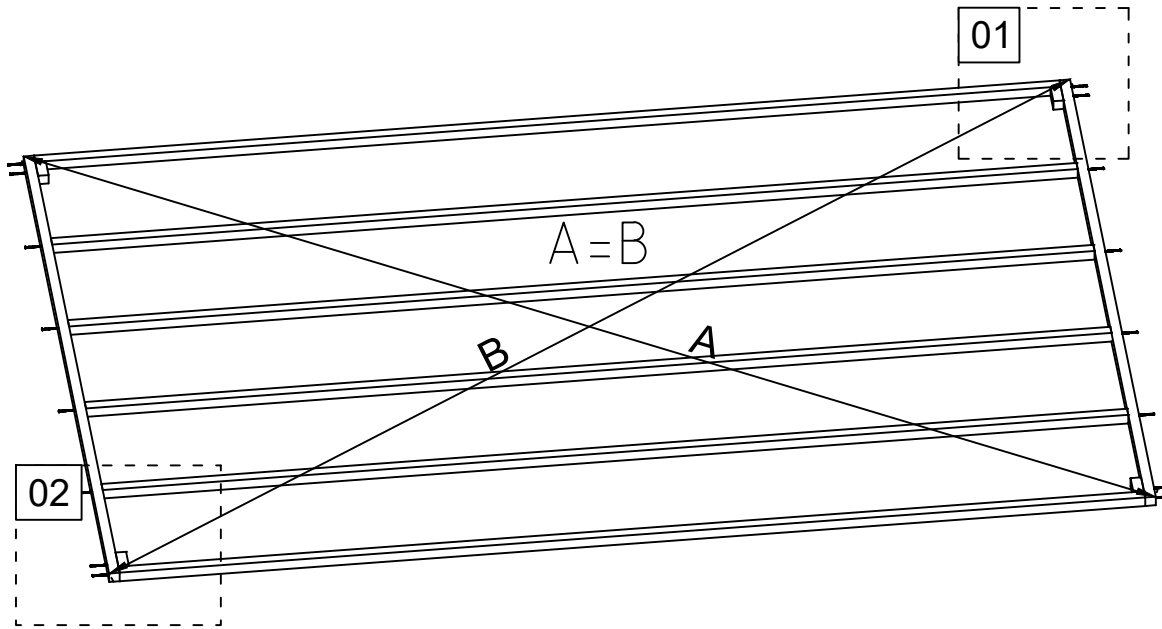

Art. Nr. 2853500

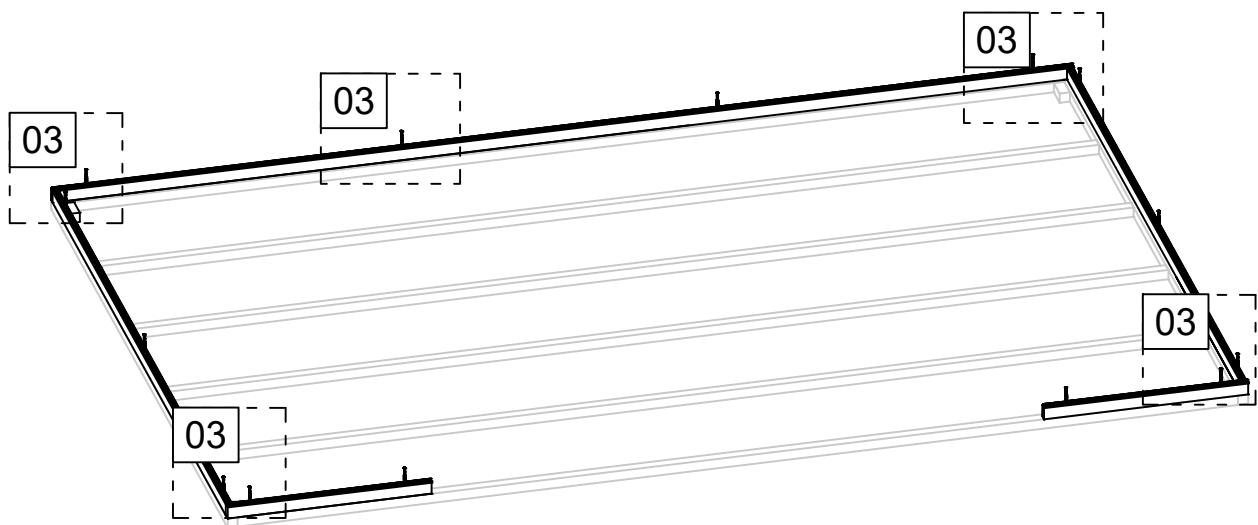

03

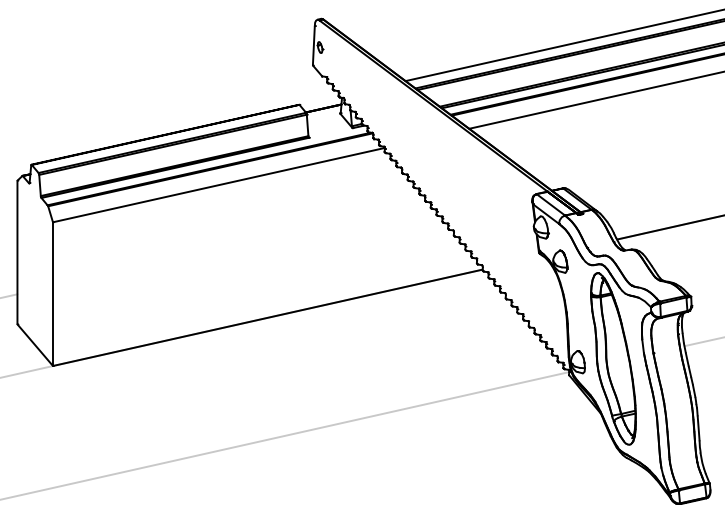

03

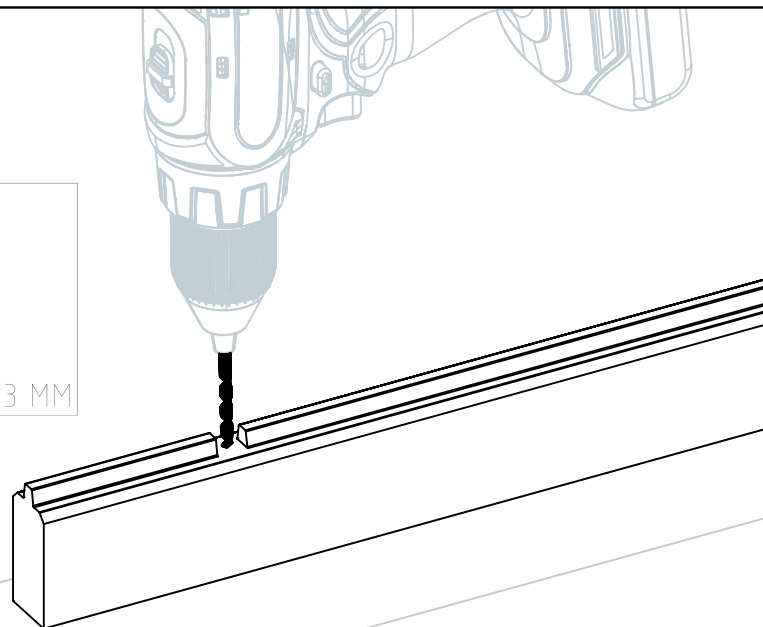

03

HS16

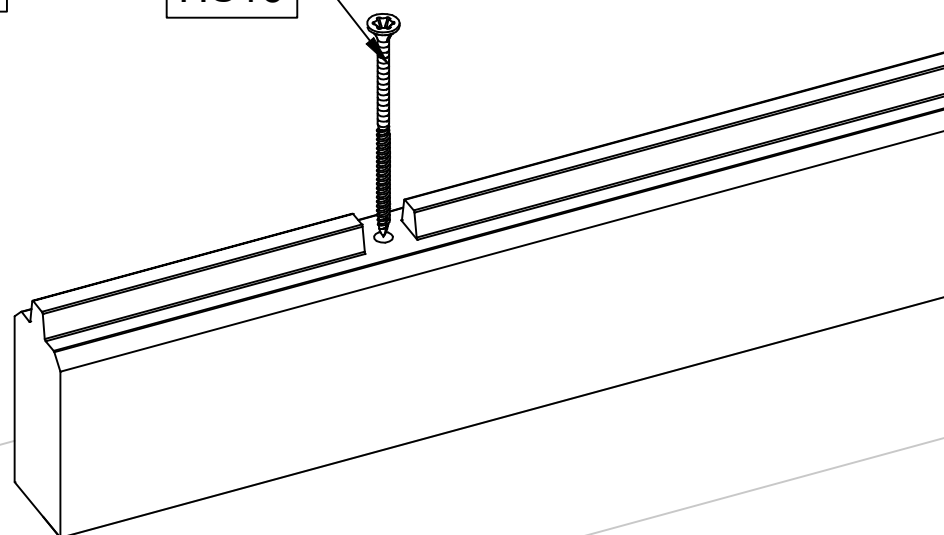

Art. Nr. 2853500

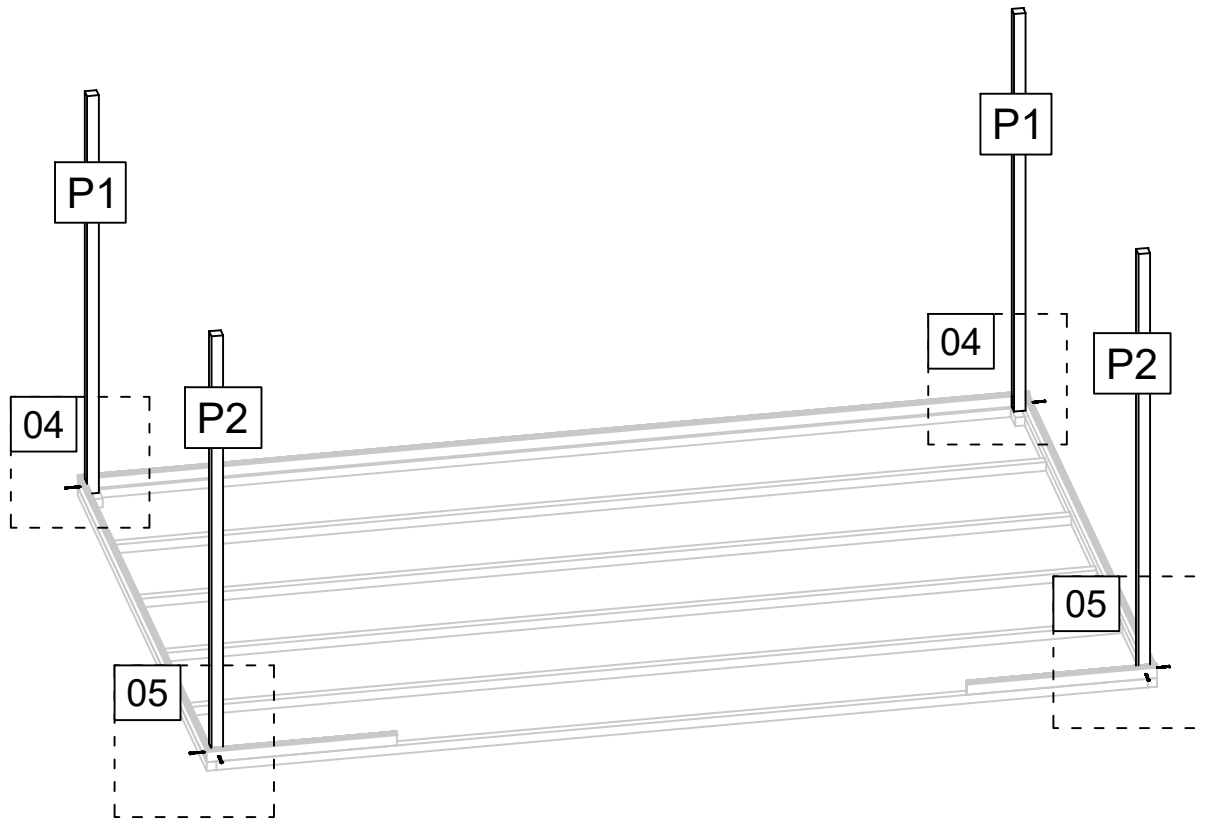

04

P1

≈5,5

≈5,5

HS13

05

P2

HS13

Art. Nr. 2853500

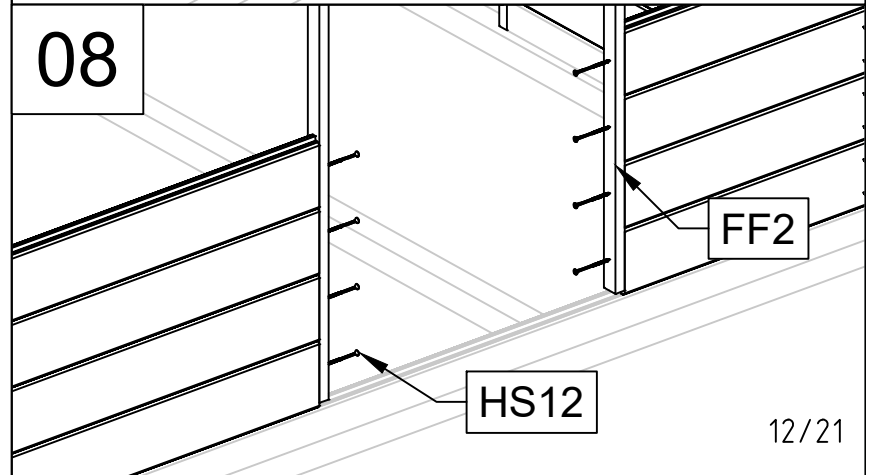
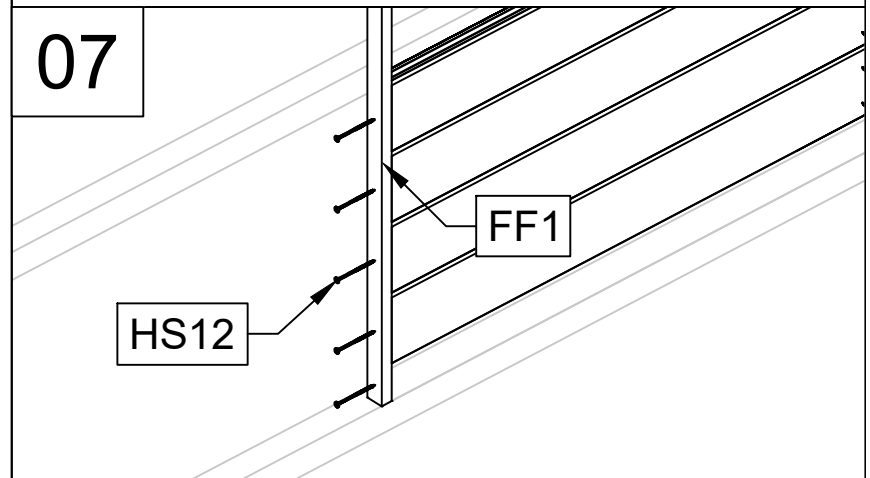
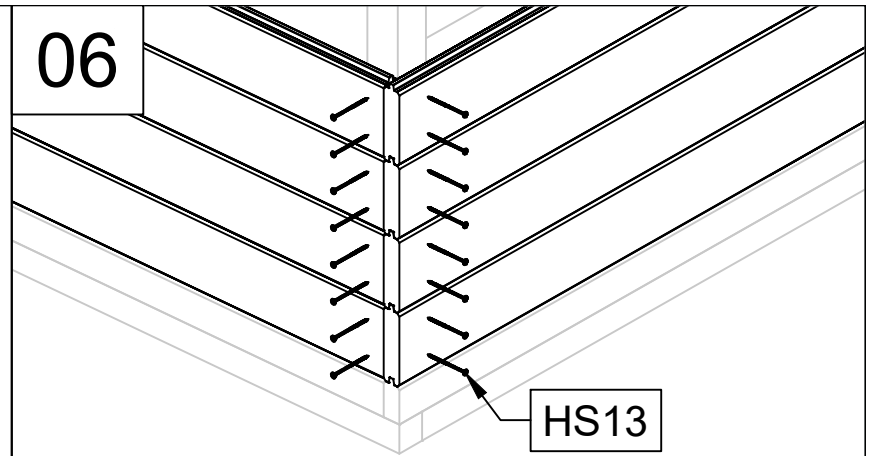
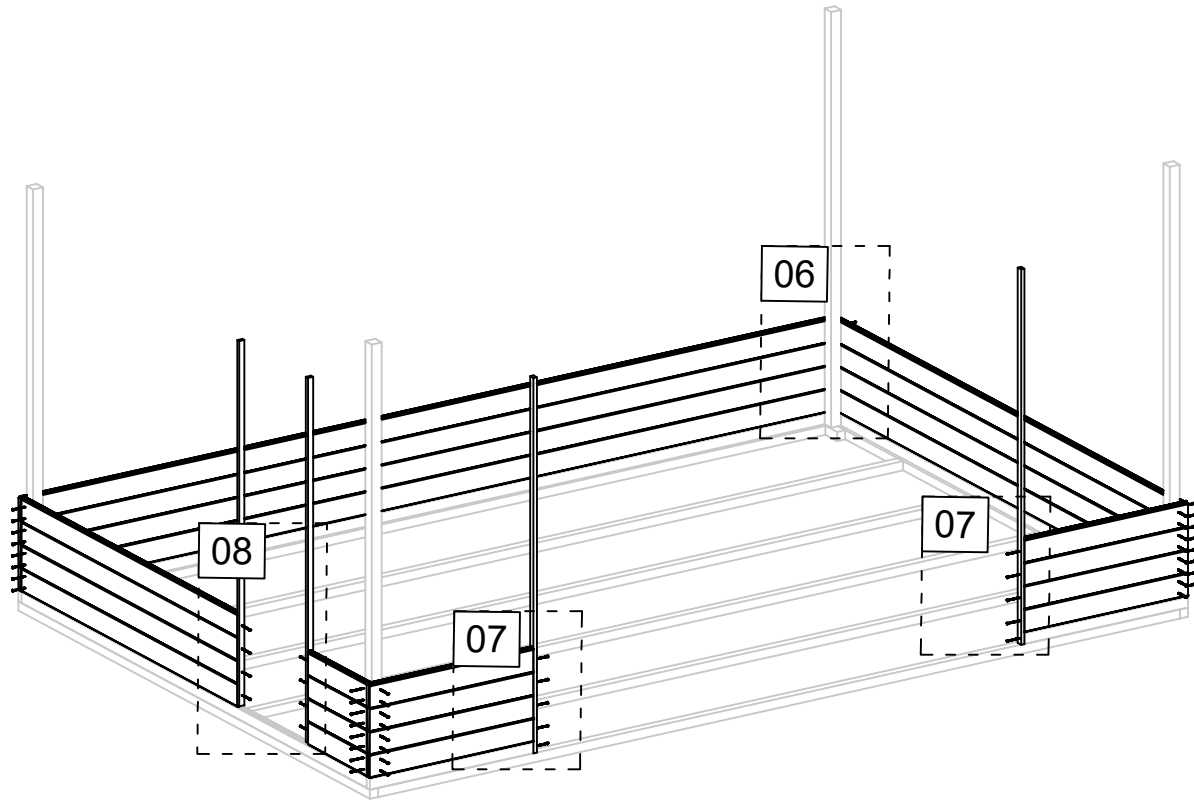

Art. Nr. 2853500

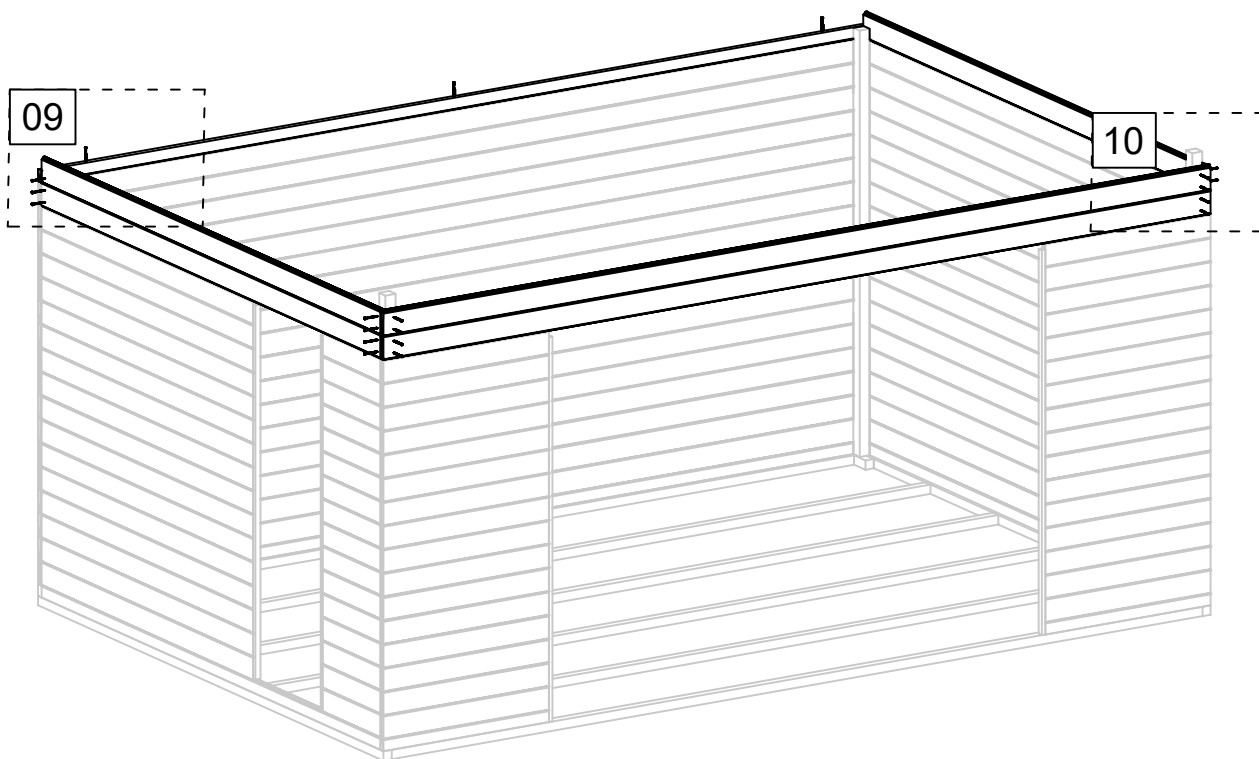

09

HS16

HS13

HS13

10

HS13

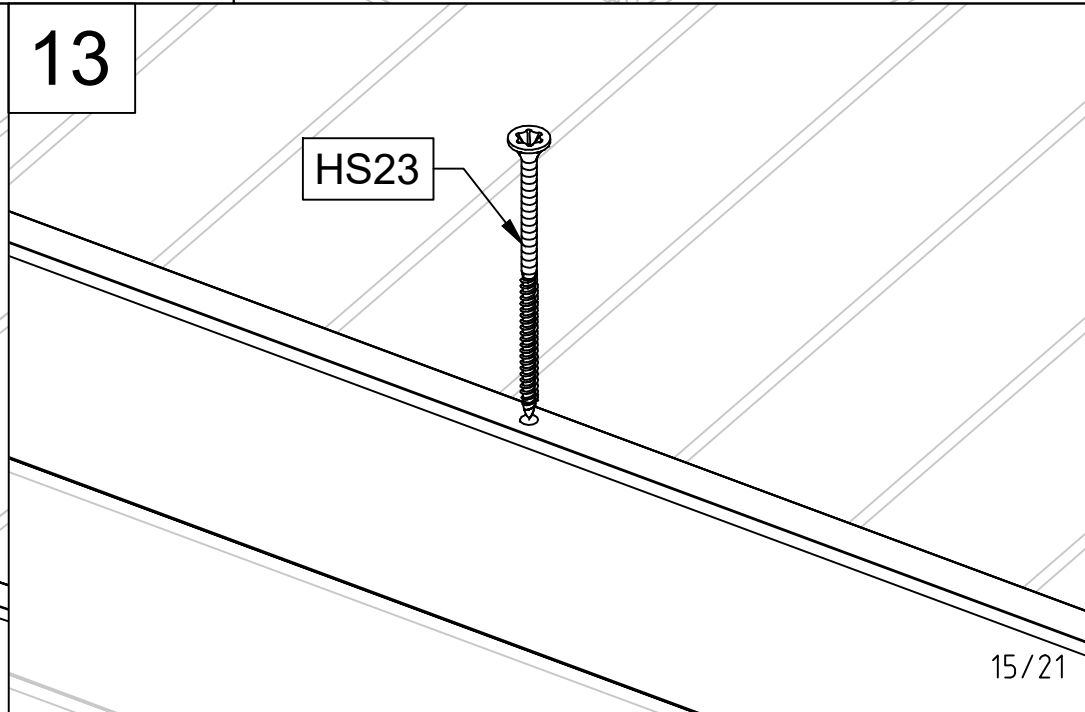
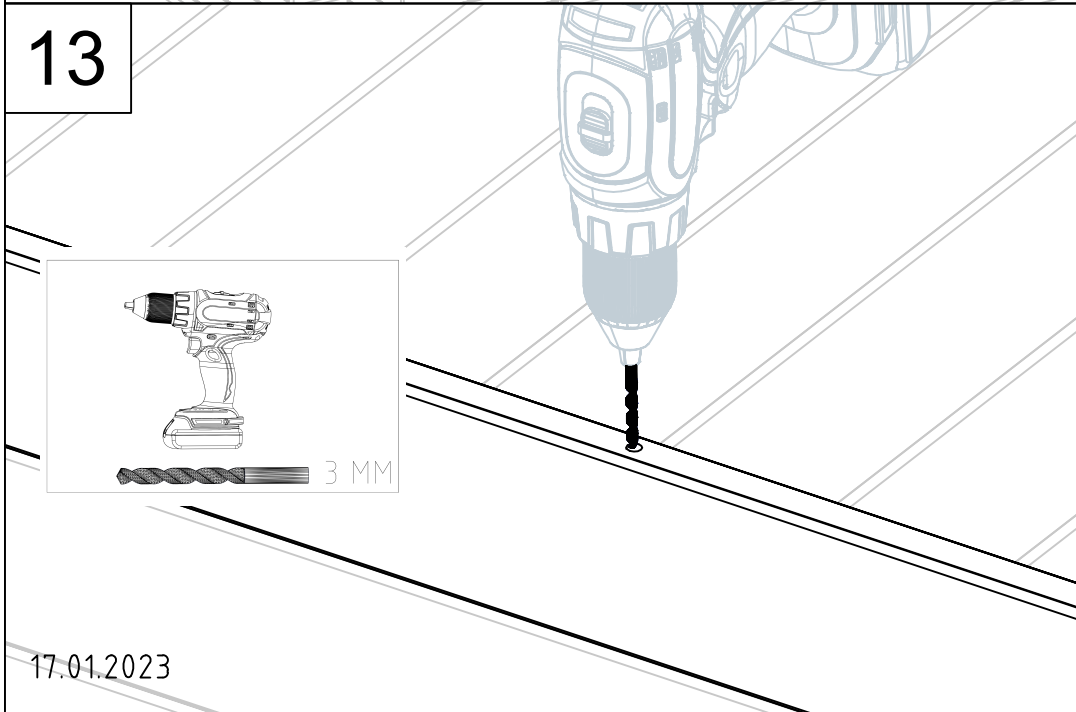
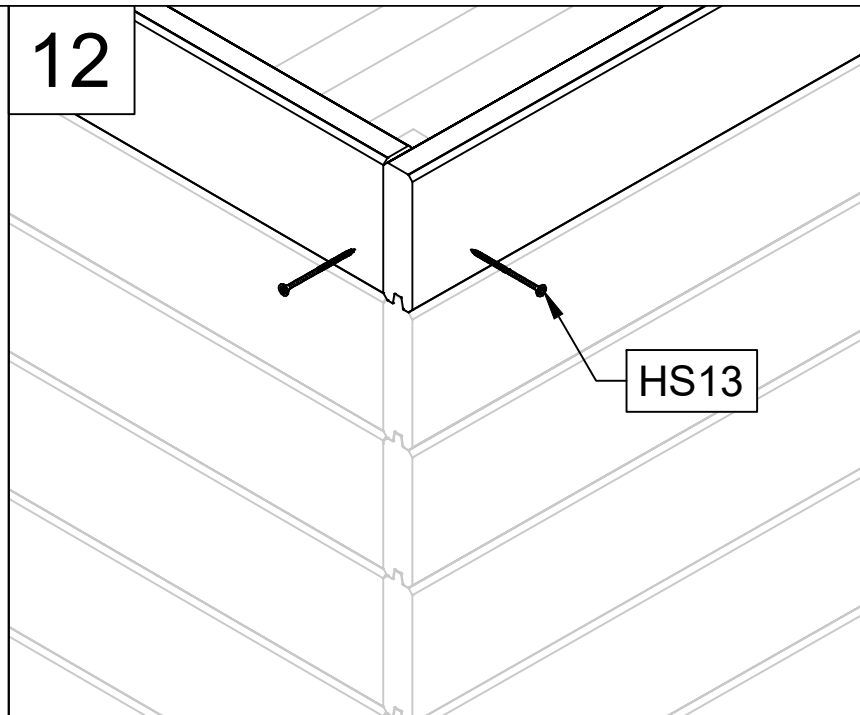
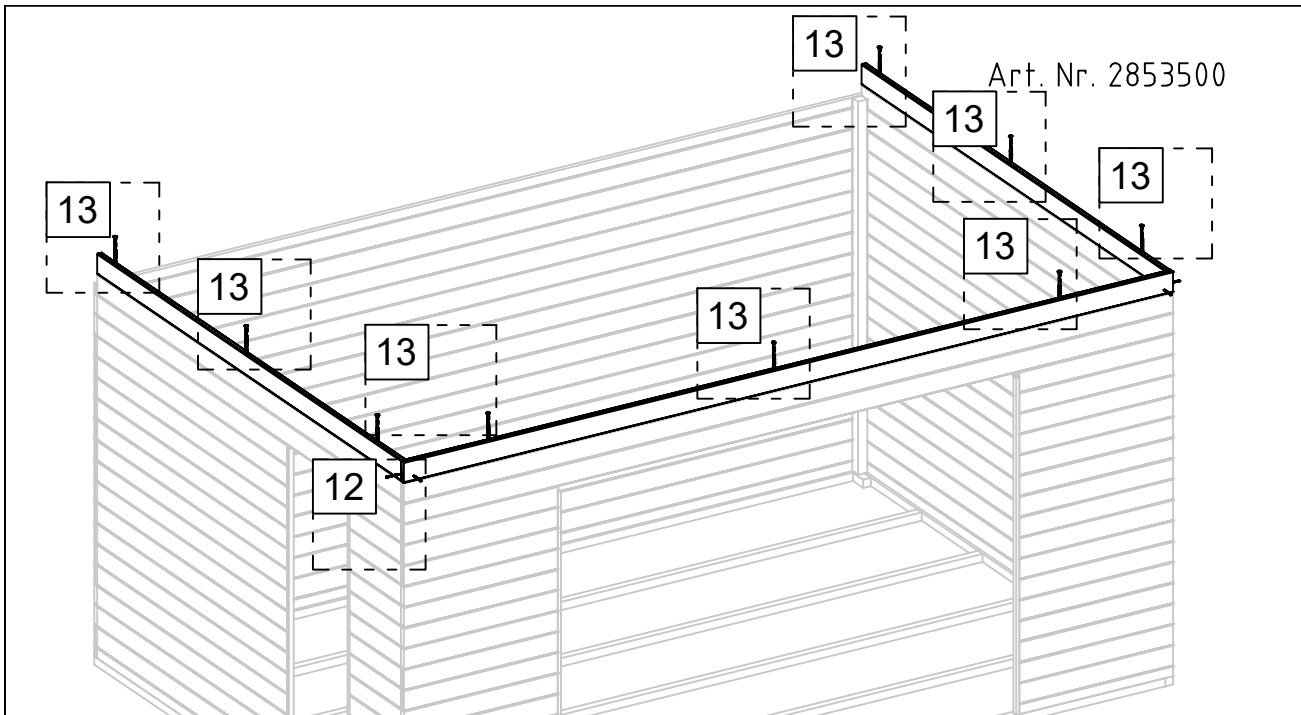

Art. Nr. 2853500

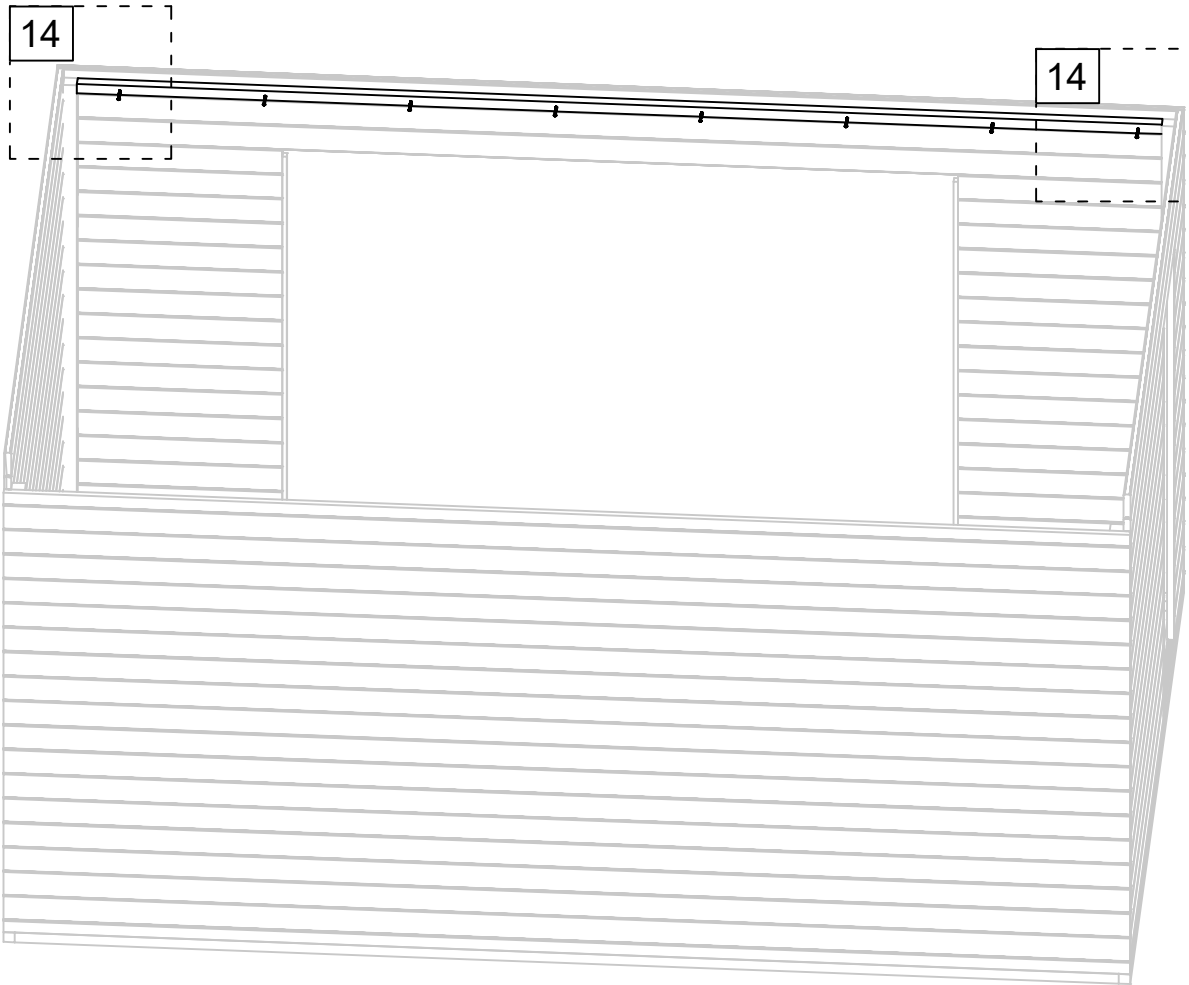

14

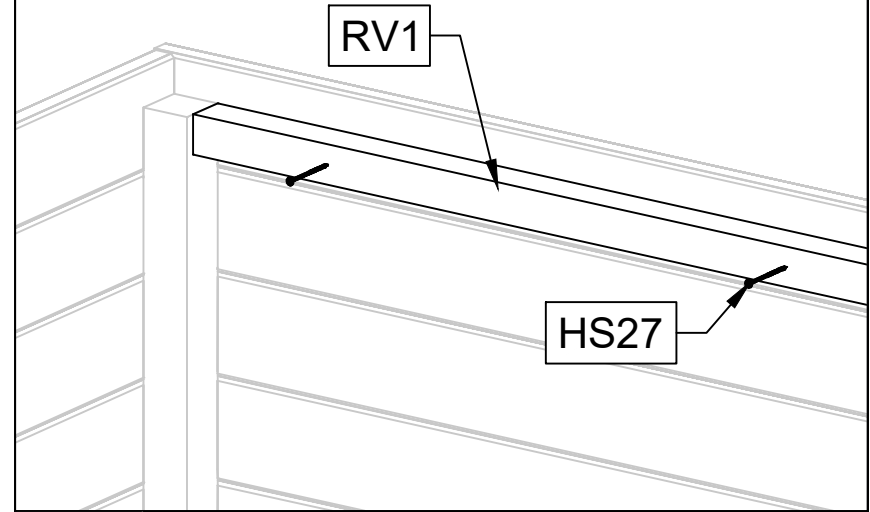

14

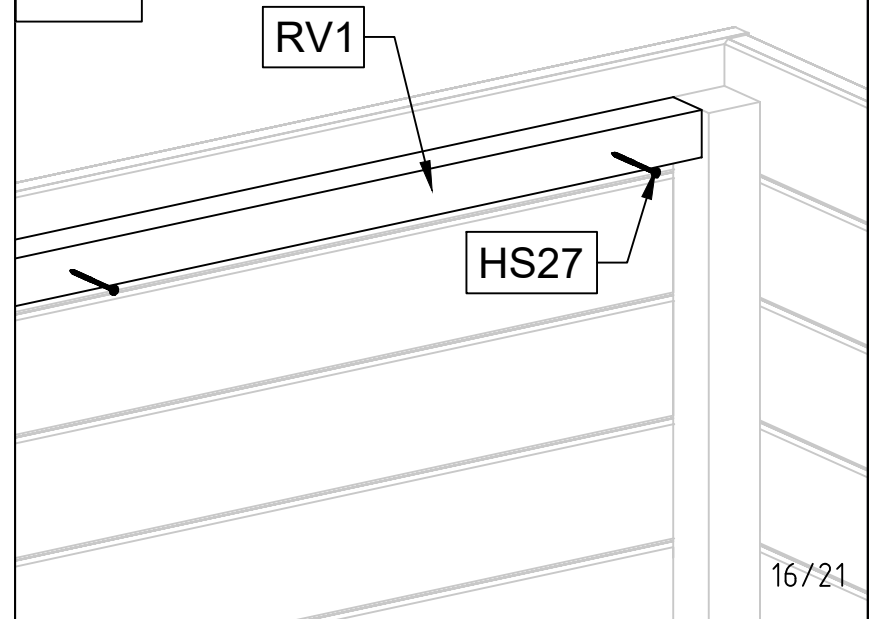

Art. Nr. 2853500

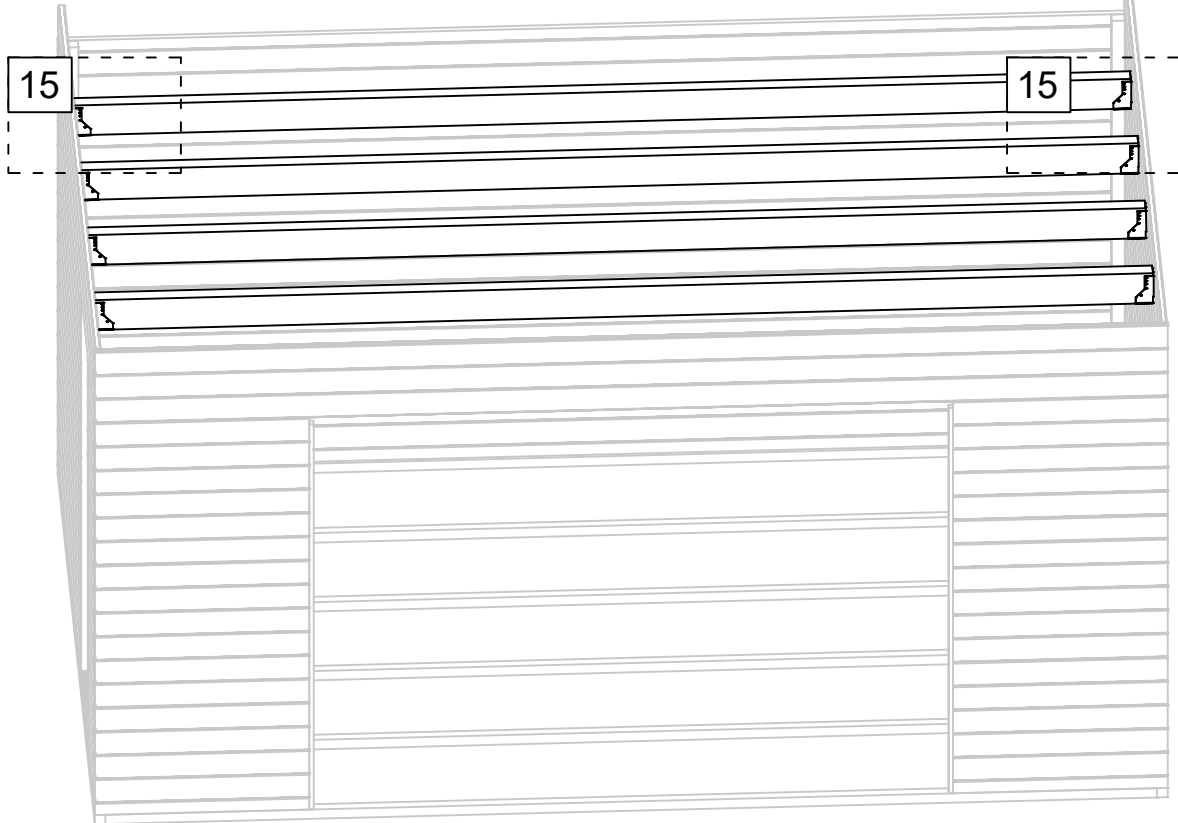

15

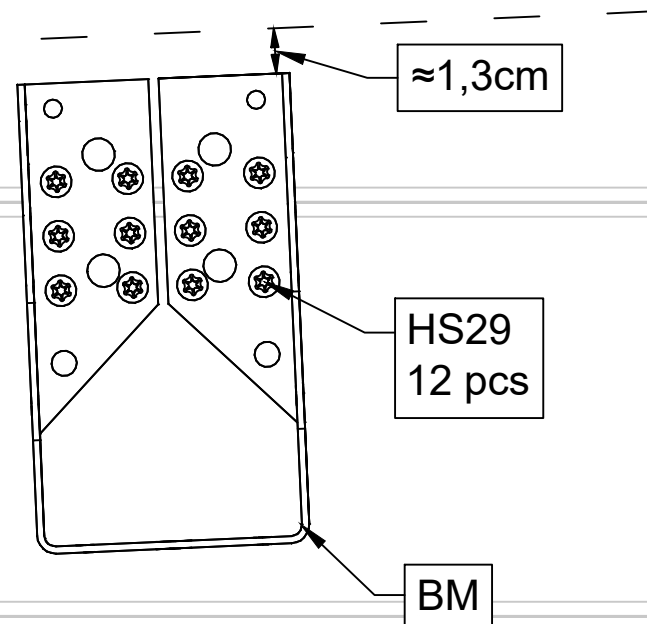

15

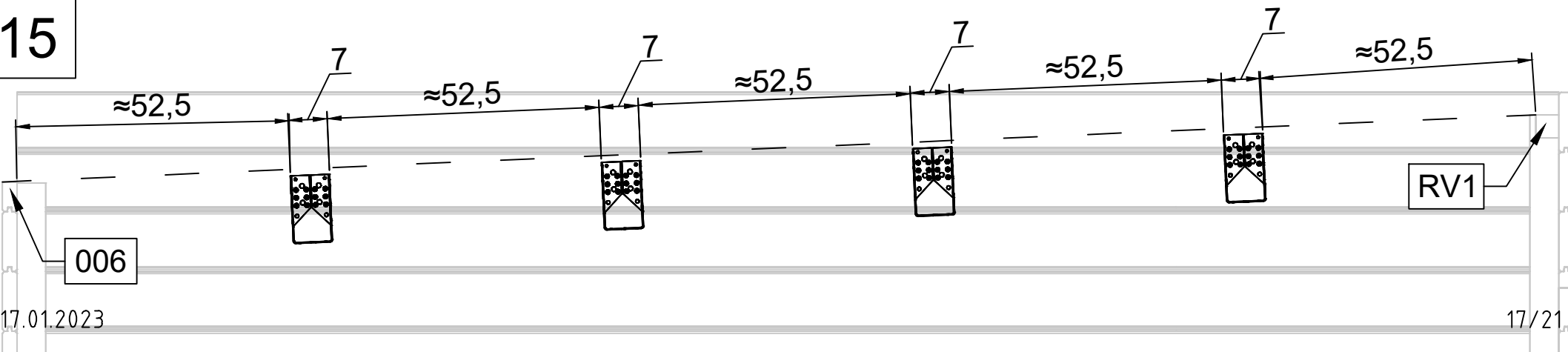

Art. Nr. 2853500



16

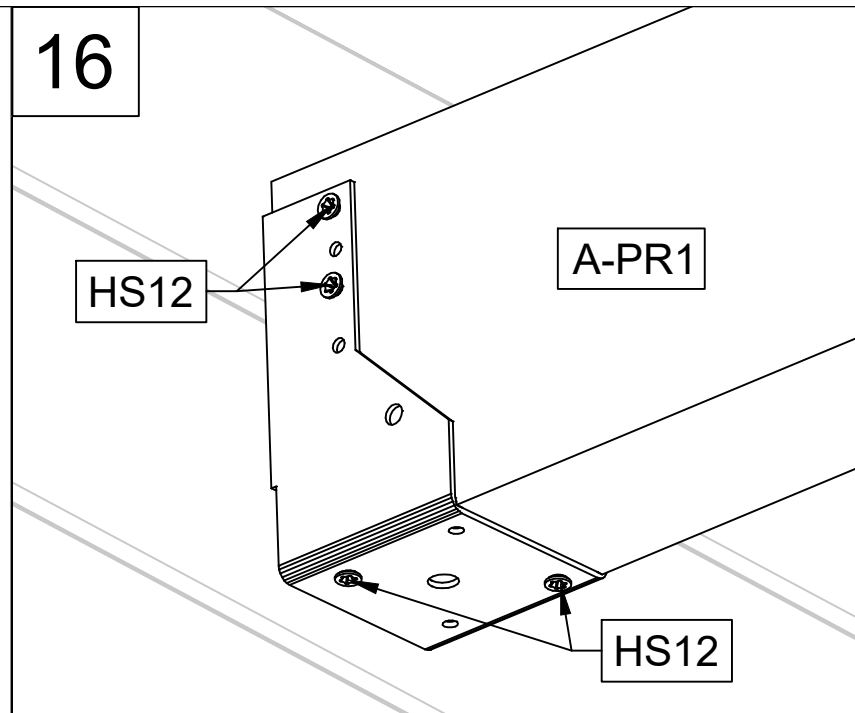

16

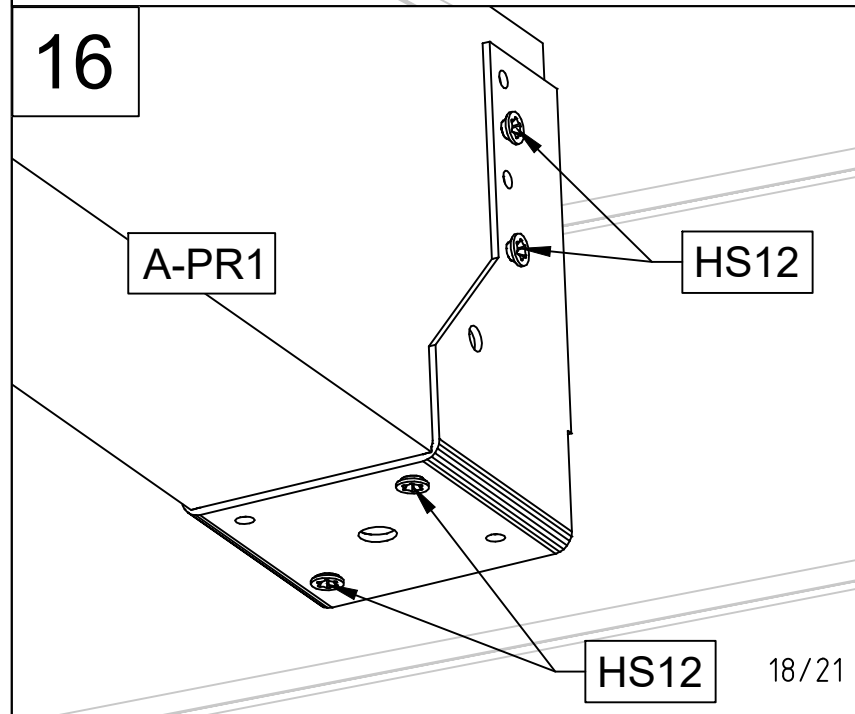

Art. Nr. 2853500

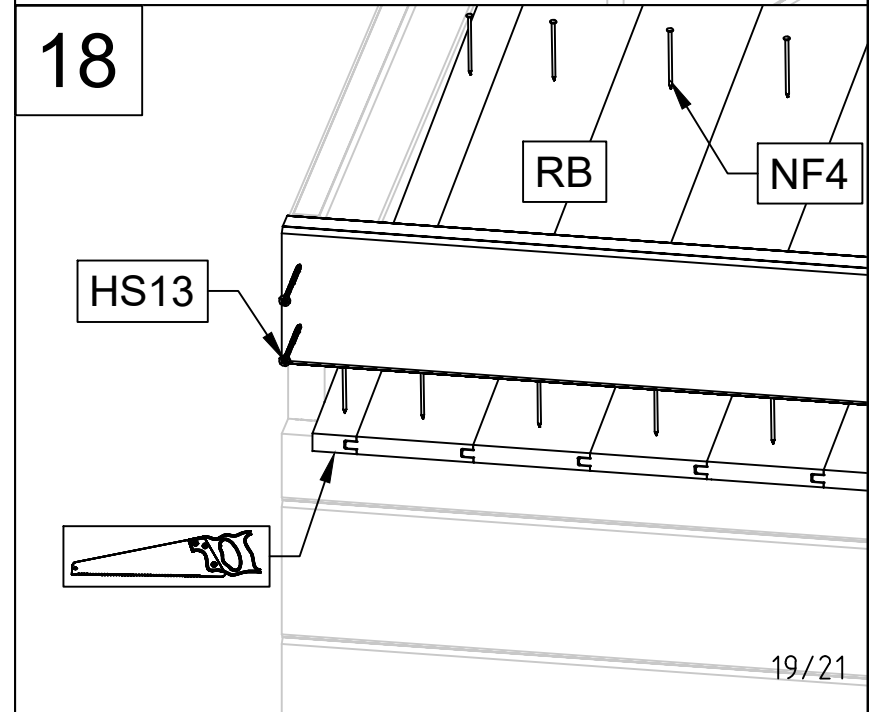
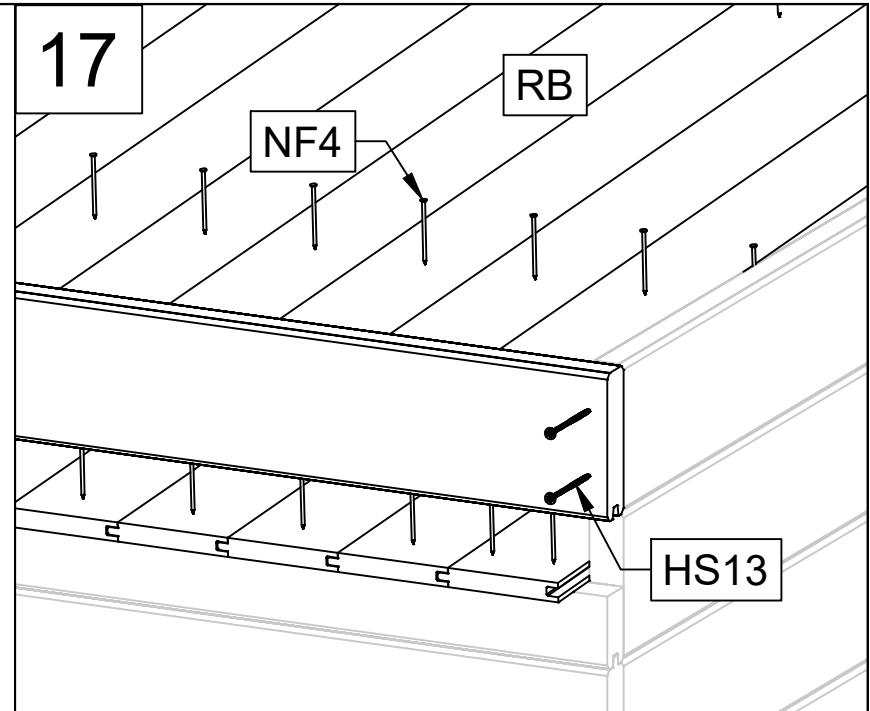
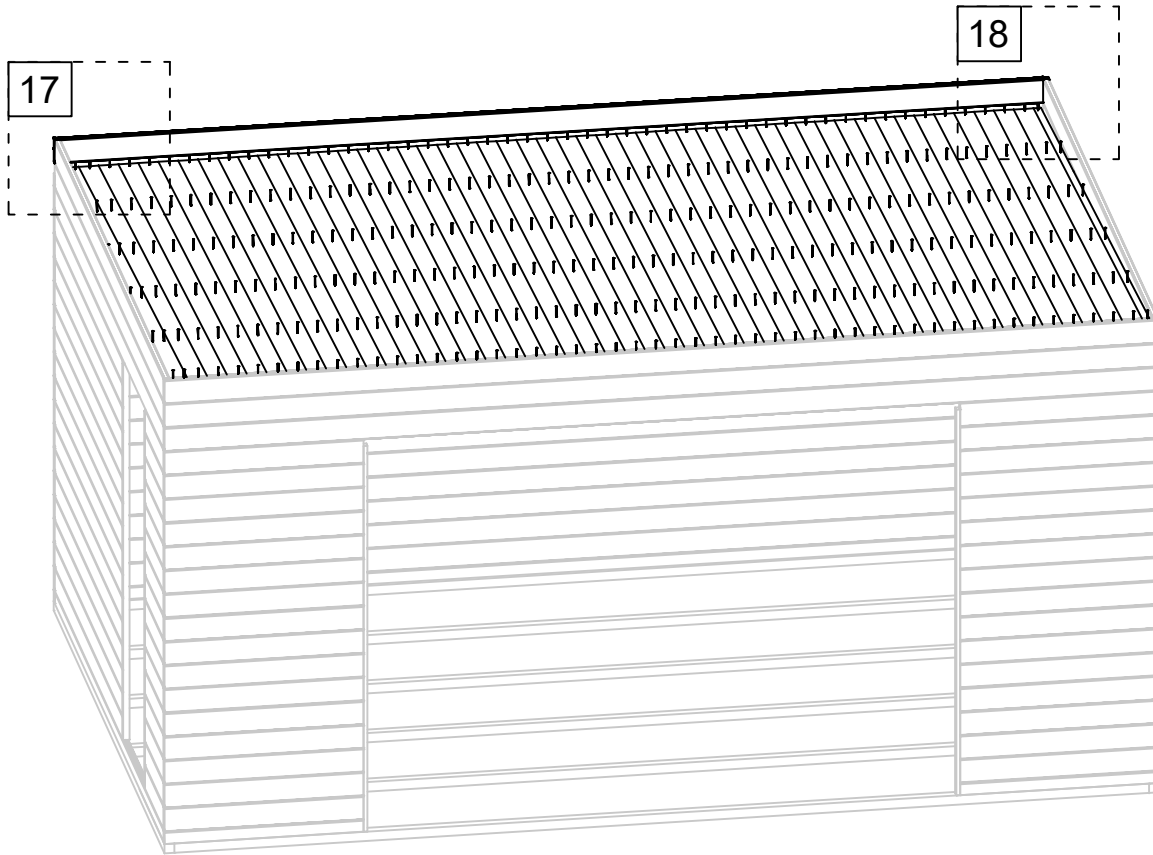

Art. Nr. 2853500

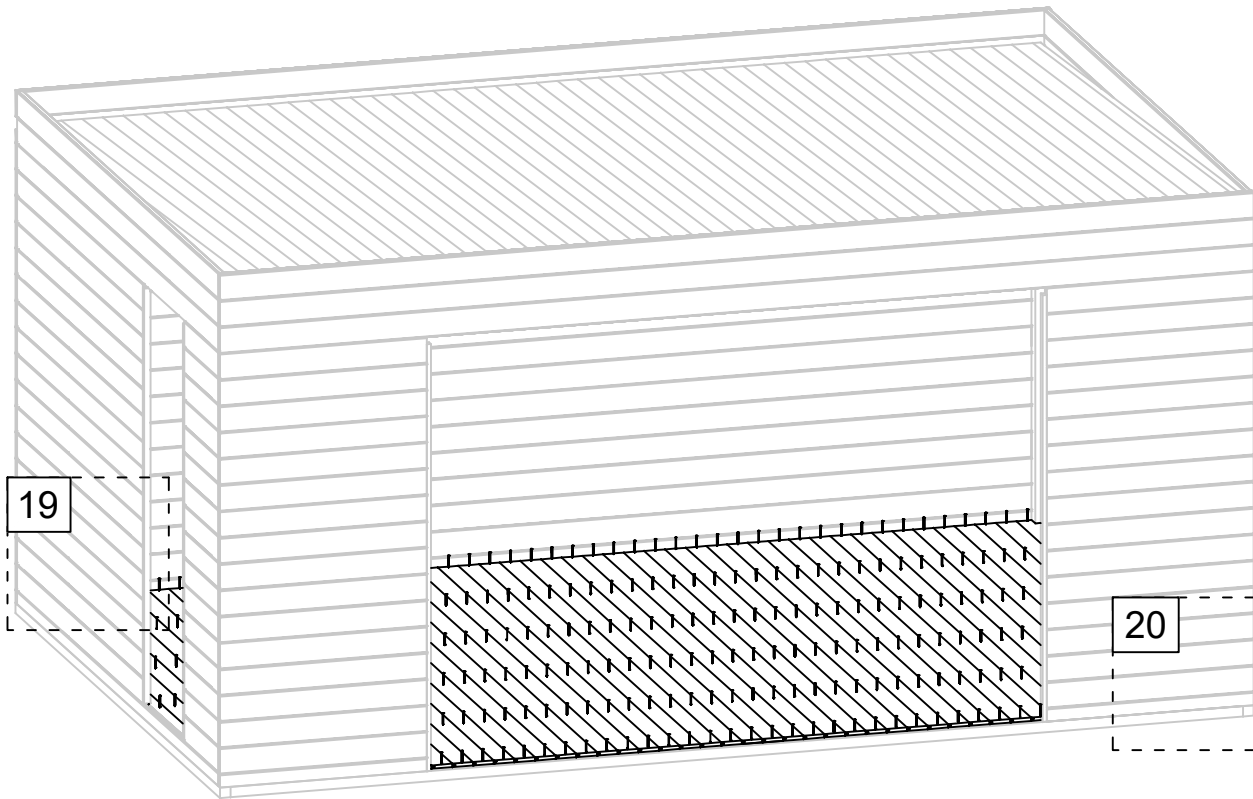

19

20

19

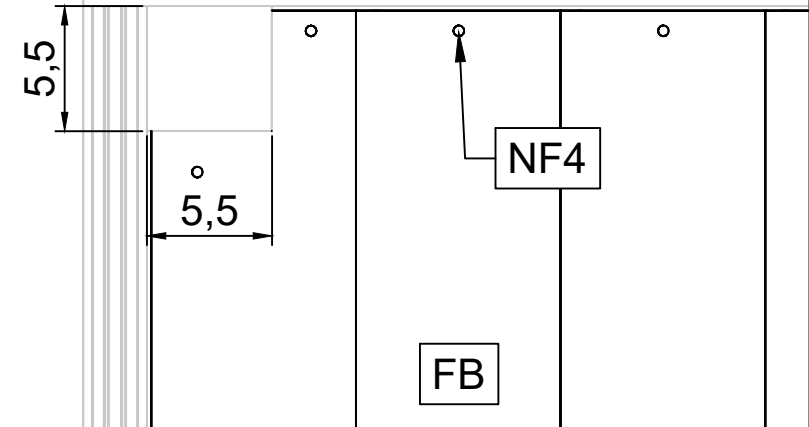
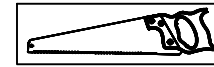

20

NF4

FB

5,5



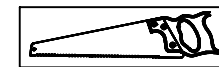

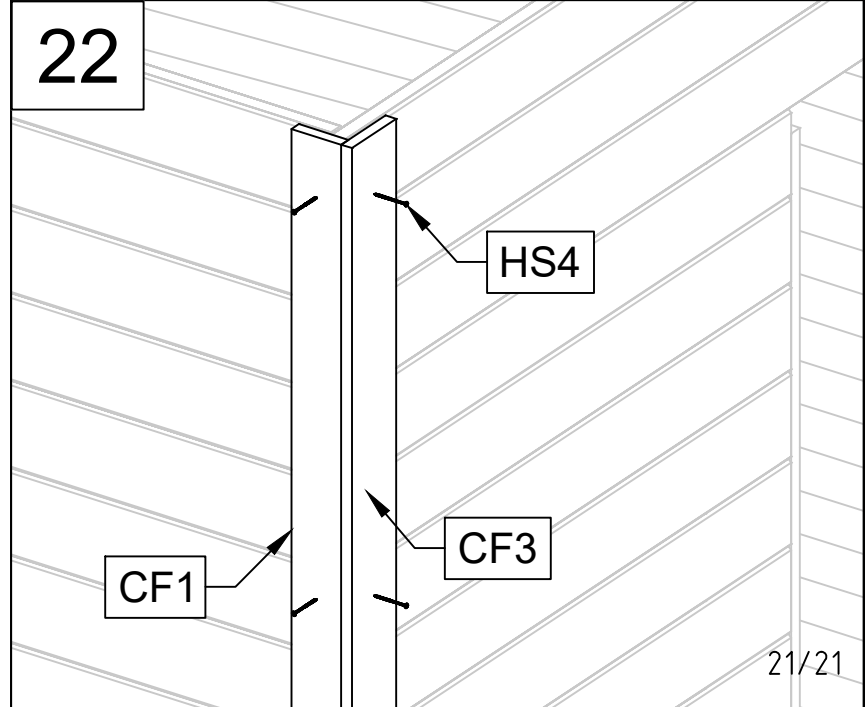
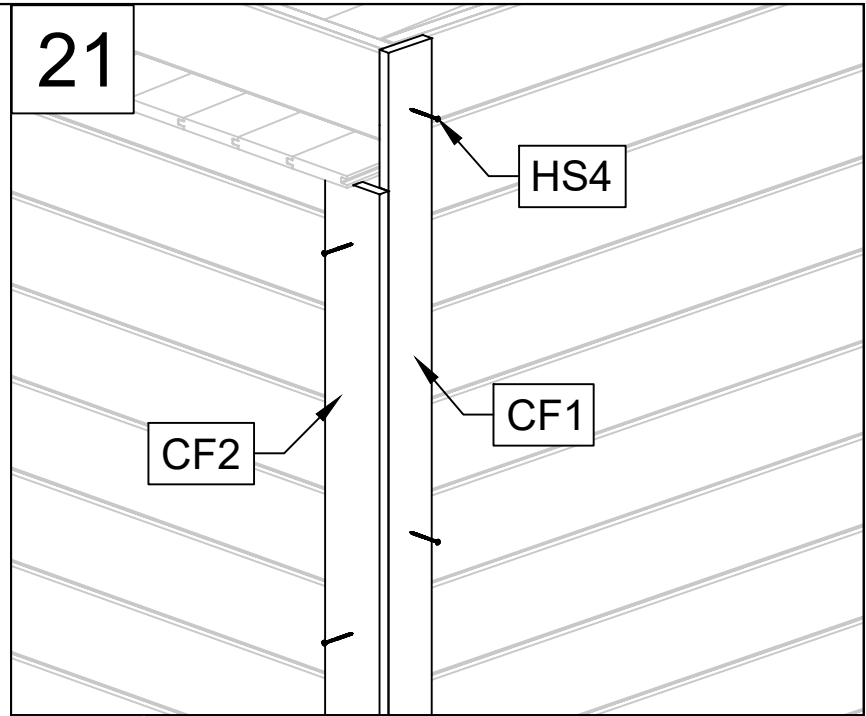
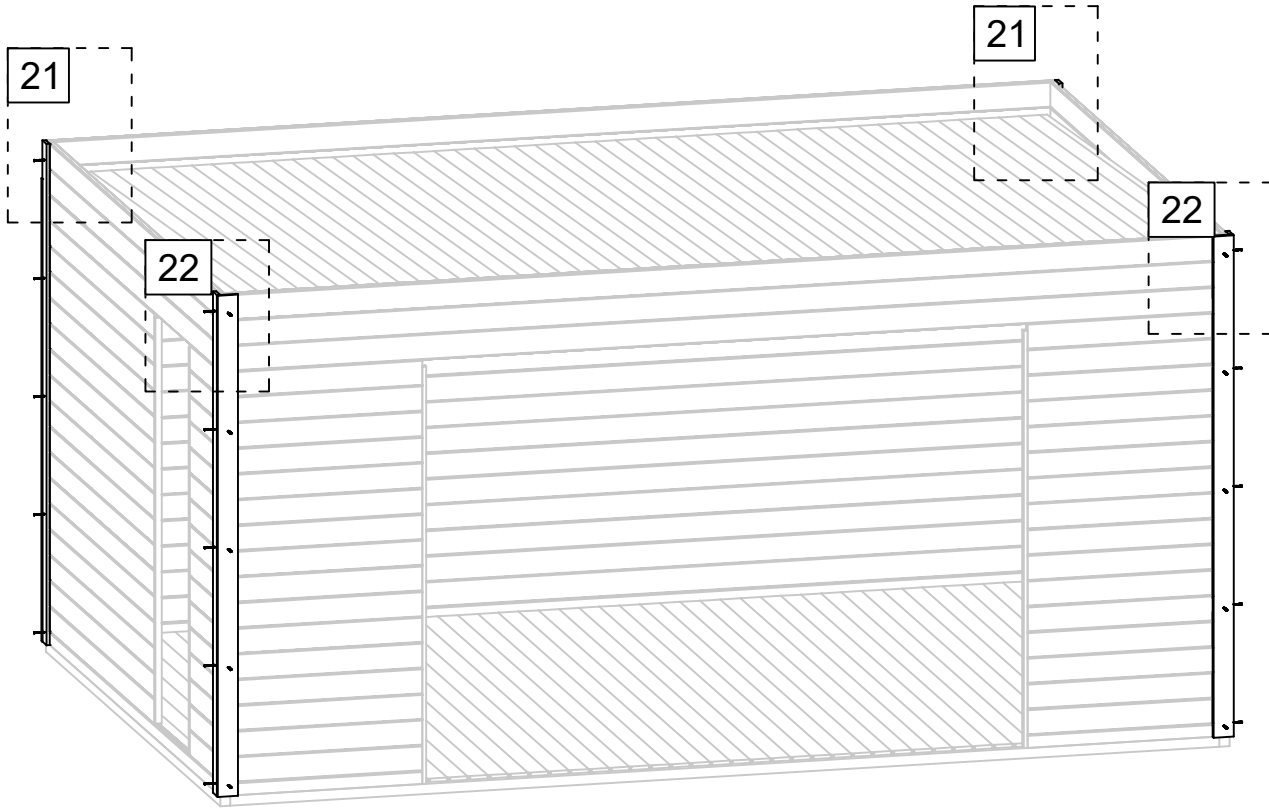

5,5

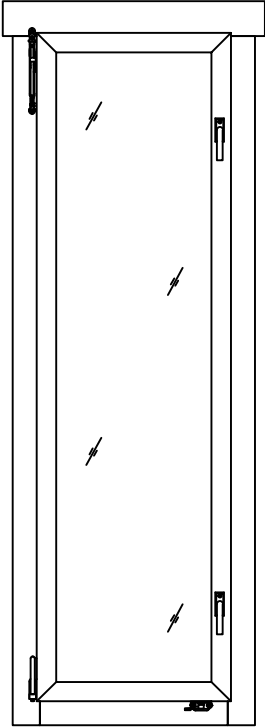
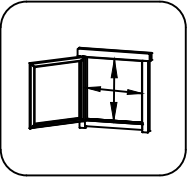
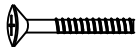
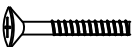

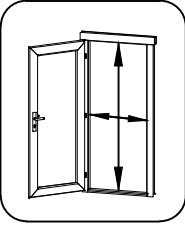
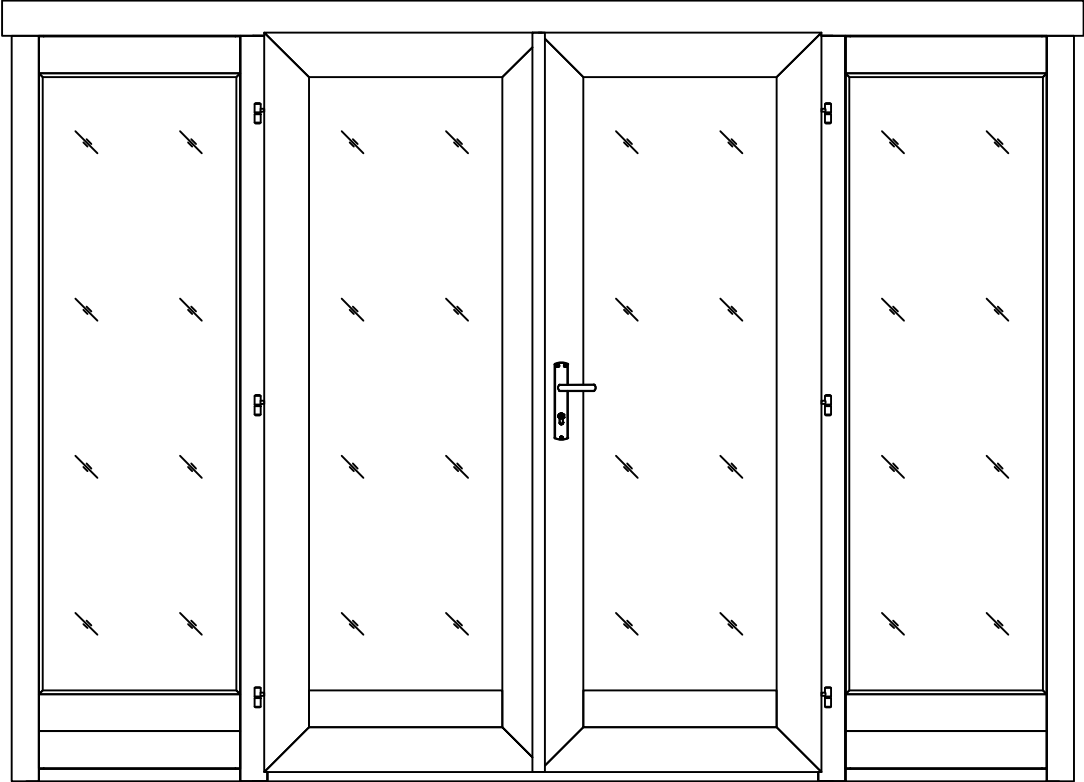
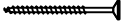
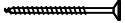
Art. Nr. 2853500

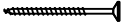

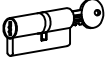
Pos	29.01.2016 Piece list - Stückliste - Liste des pièces - Elementi - Stuklijst - Tükitalabel 560x1780 AK.1.100.SSV SGC	1/1	Q	P (mm)	L (mm)
	<p data-bbox="260 145 1289 174">Glass size - Glasgröße - Taille de la vitre - Misura del vetro - Glas afmeting - Klaasi mõõt: 416x1636 mm</p>   <p data-bbox="1364 340 1497 369">460x1680 mm</p>				
FS1	Window handle fittings - Fenstergriff - Poignee de fenetre - Maniglia c/ferramenta - Raamhendel -/grendel -/klink - Aknalink		2		
FSP	Bolt for window handle fittings - Bolzen für fenstergriff beschlag - Vis pour fixation poignee de fenetre - Bullone x apertura manuale finestra - Schroef voor raamhendel - Akna käepideme polt		4		

Pos	19.03.2022	Piece list - Stückliste - Liste des pièces - Elementi - Stuklijst - Tükítabel 2658x1850 3UK.1.100.SVP.M SGC	1/1	Q	P (mm)	L (mm)
		Glass size - Glasgröße - Taille de la vitre - Misura del vetro - Glas afmeting - Klaasi mõõt: 514x1487mm				
						 1394x1768 mm
						
HS9	Screw for covering moulding - Schrauben für deckungsprofil - Vis de fixation profils horizontaux haut inférieur et extérieur d'encadrement de porte - Vite per cornice di copertura - Schroef voor afdekprofiel - Krugi piirdelauale		14	3.5x50		
HS4	Screw for door fillet - Schraube zur befestigung türleiste - Vis pour fixation baguette d'arrêt de porte - Viti per massellino della porta - Schroef voor deurlijst - Krugi ukse kokkuvältsiliistule		5	3x30		
HS1	Screw for door jamb - Schraube für türrahmen - Vis de fixation partie haute avec montants du cadre de porte - Viti x fissaggio montanti porte - Schroef voor deurkozijn - Krugi ukse lengile		6	5x90		
HS25	Screw for doorstep - Schrauben für swelle - Vis pour fixation barre de seuil - Vite per soglia della porta - Schroef voor deurdorpel - Krugi lävepakule		3	4.5x65		
TL4	Door handle fittings - Türgriff - Poignée de porte - Maniglie - Deurhendel / klink - Ukse käepide VU		1			
TL5	Set of door lock covers - Schlossblenden - Set de garnitures de porte - Copertura serrature - Slot sluitplaat set - Ukse lukuplaat		1			
	Cylinder lock - Zylinderschloss - Barillet de porte - Serratura - Cylinder slot - Ukse lukusüdamik		1	30x35		
	Striker for barrel bolt - Hülse für grendelriegel - Gache au sol du targette - Boccola per fermo della porta - Huls voor vergrendelingsschuif - Vasturaud ukse servariivile		2			

