

Caroline 2
Art. Nr. 9904300
1/5

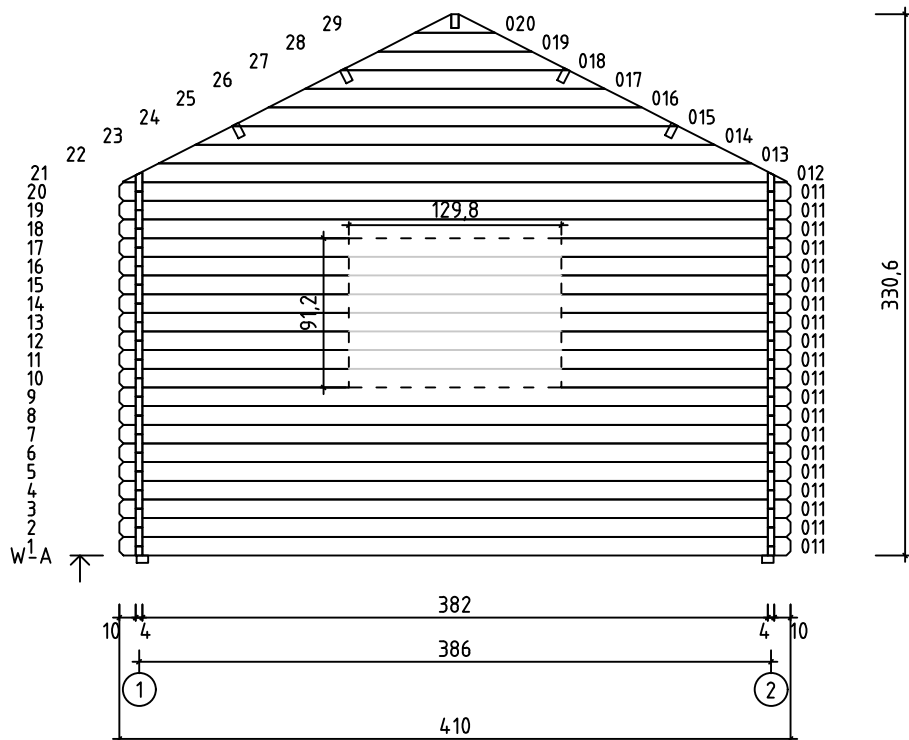

15.02.2021

Art. Nr. 9904300

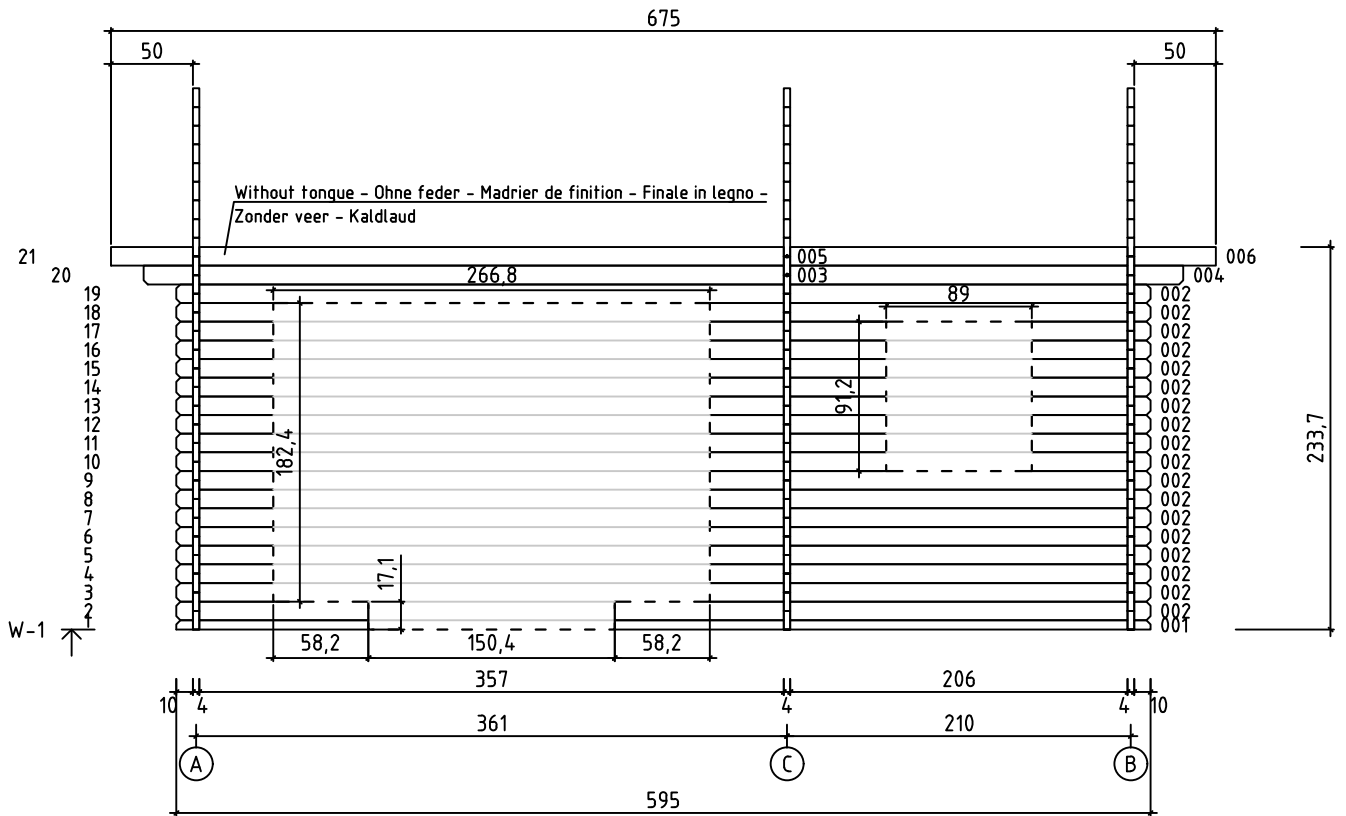

Art. Nr. 9904300

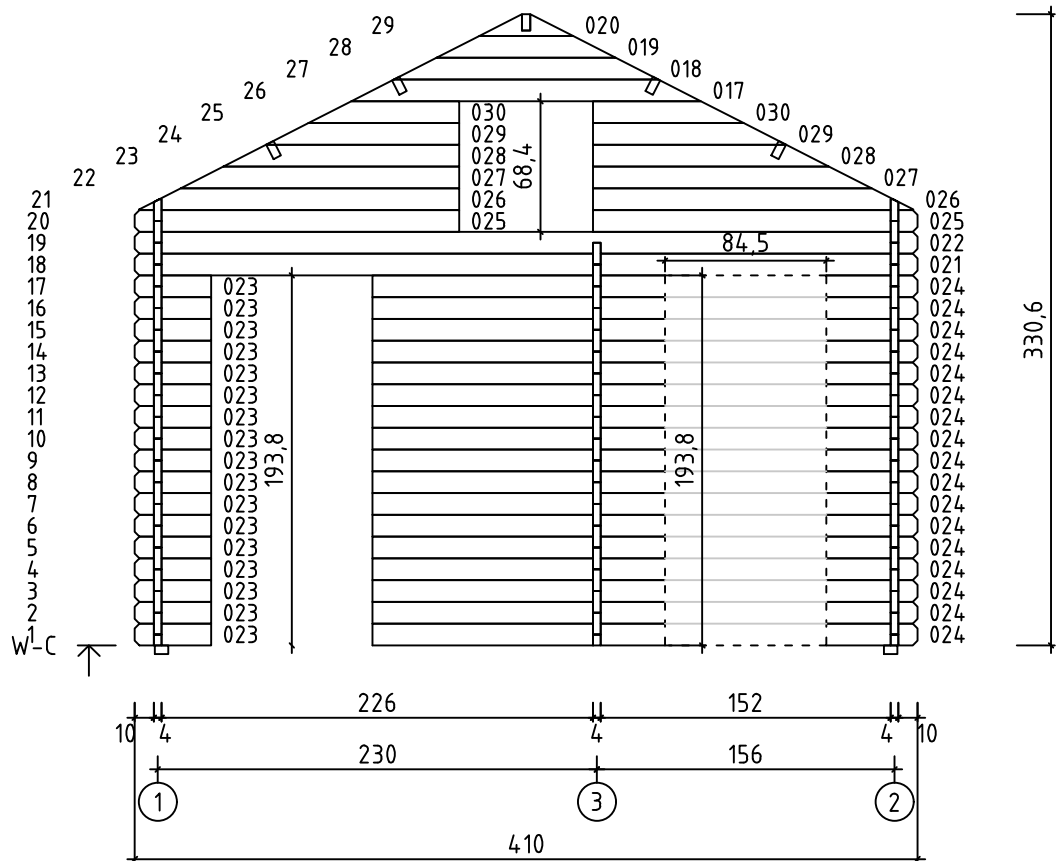
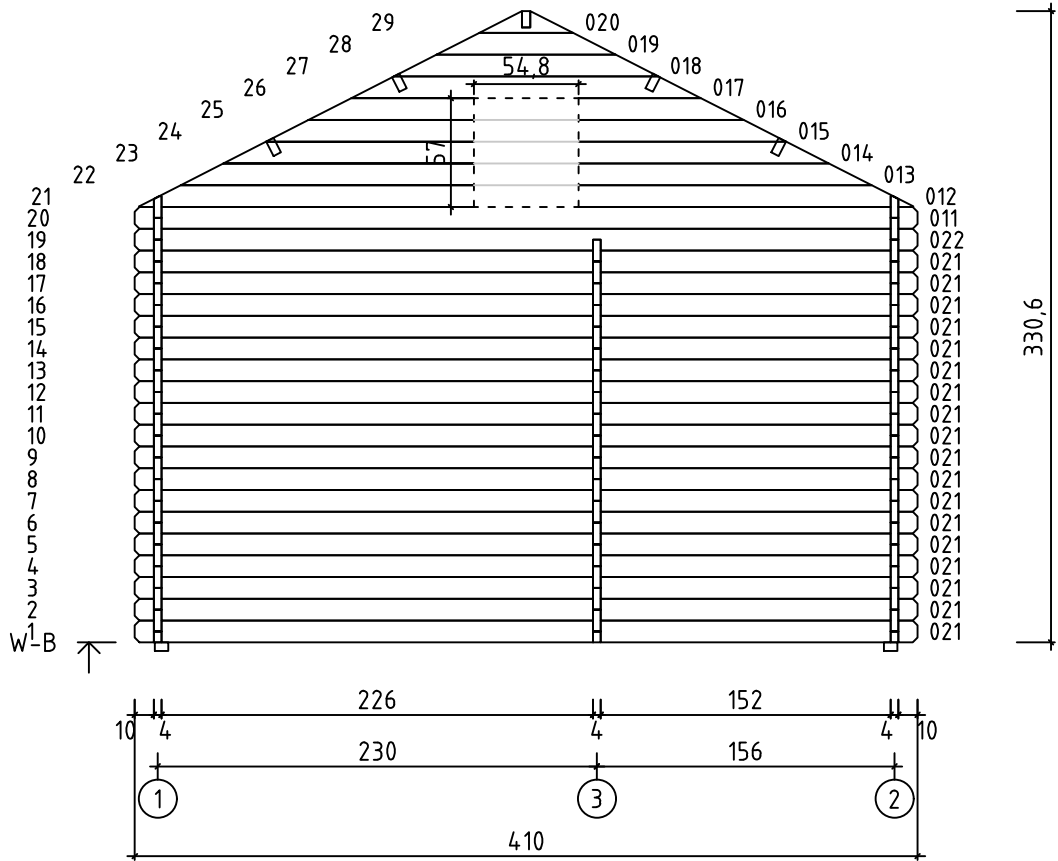

Art. Nr. 9904300

You can choose the location of the doors and windows by cutting the wall logs as shown in the picture (see the dotted line).

Dafür sind aber werksseitig keine aussparungen vorgesehen so dass sie sowohl Fenster als auch Tür individuell verbauen können. eine anleitung hierfür entnehmen sie bitte der Montageanleitung (siehe bild).

Vous pouvez choisir l'emplacement des portes et des fenêtres en coupant les madriers du mur comme indiqué sur les images (voir les lignes pointillées)

Possibilità di scegliere dove posizionare le porte e le pareti secondo l'immagine (linee tratteggiate)



U kunt de locatie van de deuren en ramen kiezen door de muurblokken er uit te zagen, zoals in de afbeeldingen staat weergegeven (zie de stippellijnen)

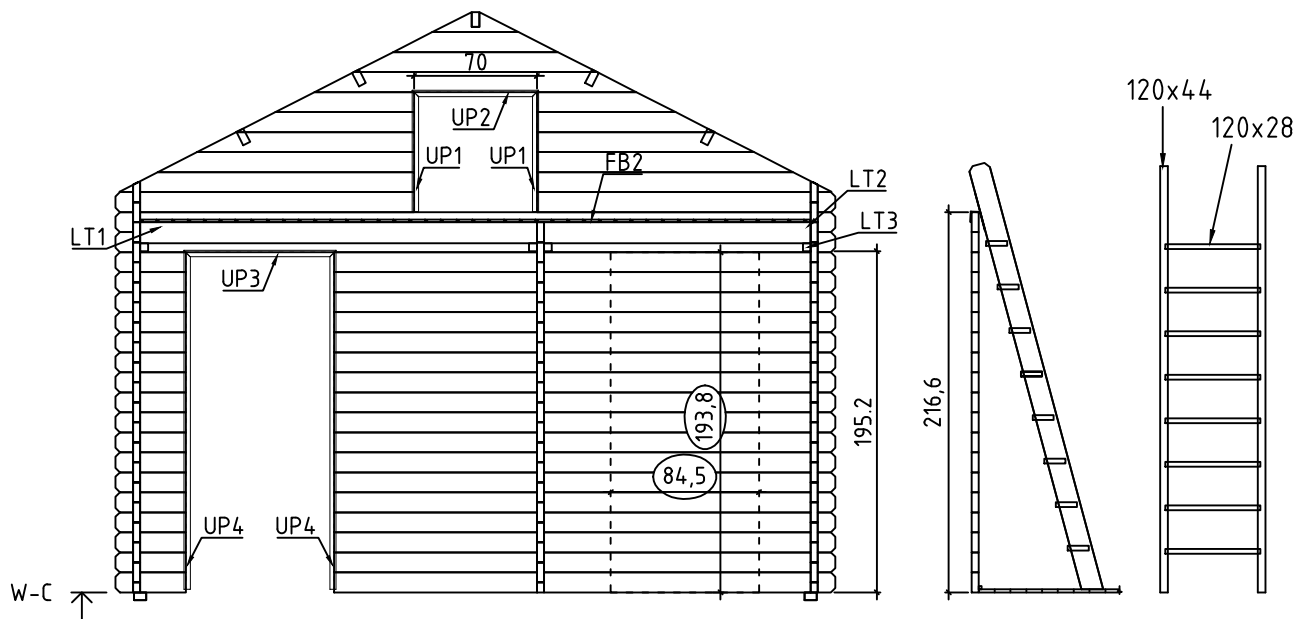

Uste ja akende asukoht on võimalik ise valida. Avatäited tuleb lõigata joonistel näidatud mõõtudes (vaadake punktiiriooni).

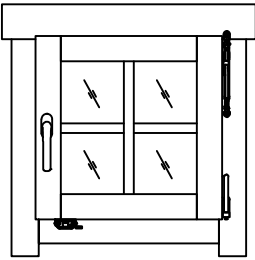
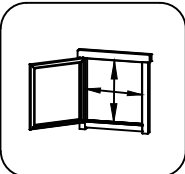
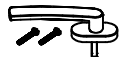
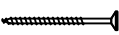

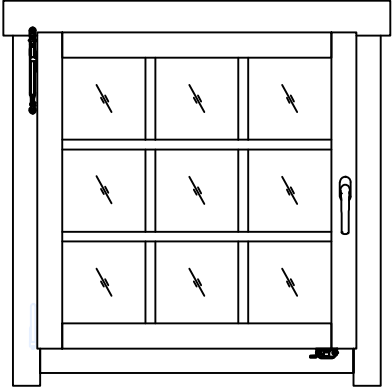
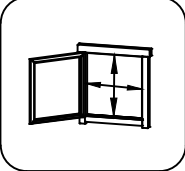
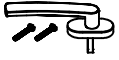



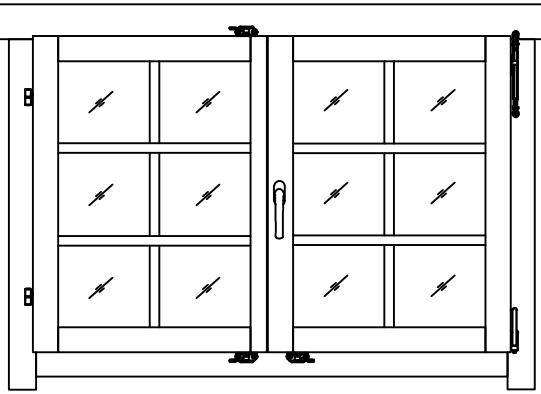
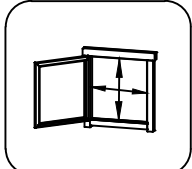
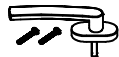

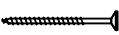

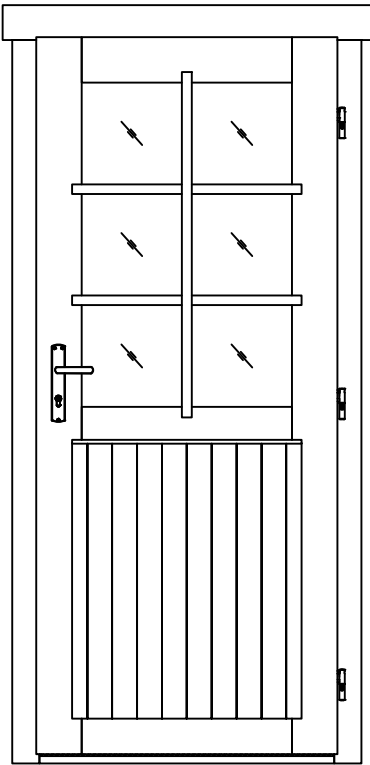
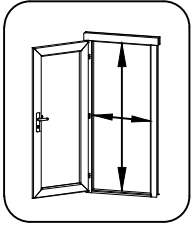
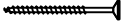
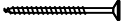

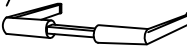

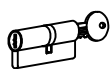

120x44 L=2520 mm 2 tk
120x28 L=542 mm 8 tk

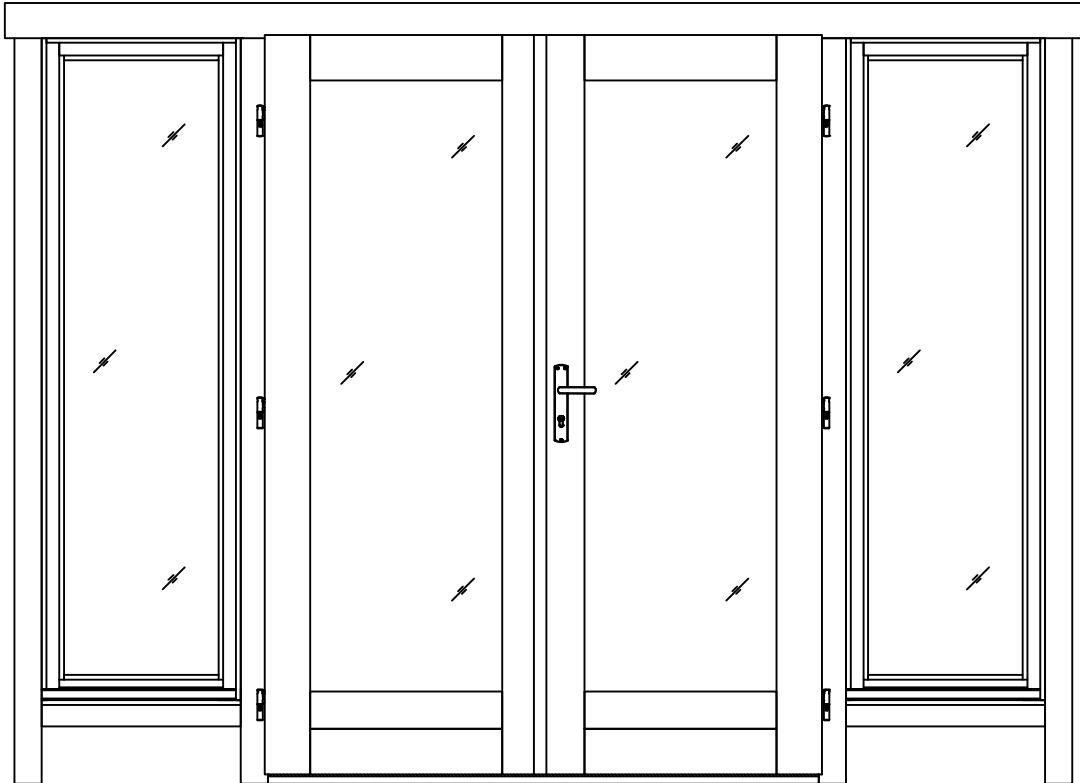
Pos	11.11.2018 Piece list - Stückliste - Liste des pièces - Elementi - Stuklijst - Tükitalabel 540x540 AK.1.104.TPSP.d DGP+	1/1	Q	P (mm)	L (mm)
	<p data-bbox="261 152 1283 183">Glass size - Glasgröße - Taille de la vitre - Misura del vetro - Glas afmeting - Klaasi mõõt: 370x362 mm</p> <div data-bbox="724 248 983 504" style="text-align: center;">  </div> <div data-bbox="1337 154 1522 327" style="text-align: right;">  </div> <p data-bbox="1366 349 1493 380" style="text-align: right;">440x444 mm</p>				
FS2	<p data-bbox="261 2040 1023 2096">Window handle fittings - Fenstergriff - Poignee de fenetre - Maniglia c/ferramenta - Raamhendel -/grendel -/klink - Aknalink</p>		1		
HS1	<p data-bbox="261 2119 1107 2197">Screw for georgian bars - Schraube für sprossen - Vis pour croisillons - Viti per unire la griglia georgiana della finestra - Schroeven voor raamverdeling - Kruvi akna petfeliistule</p>		4	2.5x20	

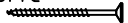
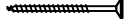
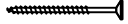
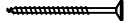
Pos	16.03.2018 Piece list - Stückliste - Liste des pièces - Elementi - Stuklijst - Tükítabel 882x882 AK.1.109.TPSV.b DGP+	1/1	Q	P (mm)	L (mm)
<p data-bbox="261 143 1283 174">Glass size - Glasgröße - Taille de la vitre - Misura del vetro - Glas afmeting - Klaasi mõõt: 712x704 mm</p> <div style="display: flex; justify-content: space-around; align-items: center;">  <div style="text-align: center;">  <p data-bbox="1369 367 1490 398">782x786 mm</p> </div> </div>					
FS2	Window handle fittings - Fenstergriff - Poignee de fenetre - Maniglia c/ferramenta - Raamhendel -/grendel -/klink - Aknalink		1		
HS1	Screw for georgian bars - Schraube für sprossen - Vis pour croisillons - Viti per unire la griglia georgiana della finestra - Schroeven voor raamverdeling - Kruvi akna petfeliistule		8	2.5x20	

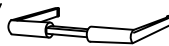
Pos	27.11.2017 Piece list - Stückliste - Liste des pièces - Elementi - Stuklijst - Tükítabel 1290x882 TAK.1.106.TPSP.a DGP+	1/1	Q	P (mm)	L (mm)
	<p data-bbox="263 156 1284 190">Glass size - Glasgröße - Taille de la vitre - Misura del vetro - Glas afmeting - Klaasi mõõt: 515x704 mm</p>   <p data-bbox="1364 347 1492 380">1190x786 mm</p>				
FS2	Window handle fittings - Fenstergriff - Poignée de fenetre - Maniglia c/ferramenta - Raamhendel -/grendel -/klink - Aknalink		1		
HS1	Screw for georgian bars - Schraube für sprossen - Vis pour croisillons - Viti per unire la griglia georgiana della finestra - Schroeven voor raamverdeling - Kruvi akna petteliistule		12	2.5x20	
HS4	Screw for window fillet - Schraube für glasleiste - Vis de filet de fenetre - Vite per assemblaggio finestra - Schroef voor glaslijst - Kruvi akna kokkuvaltšiliistule		3	3x30	

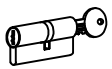
Pos	26.03.2018 Piece list - Stückliste - Liste des pièces - Elementi - Stuklijst - Tükítabel 835x1900 UK.2.056.TPVP.MMWd DGP+	1/1	Q	P (mm)	L (mm)
Glass size - Glasgröße - Taille de la vitre - Misura del vetro - Glas afmeting - Klaasi mõõt: 561x855 mm  					
HS1	Screw for georgian bars - Schraube für sprossen - Vis pour croisillons - Viti per unire la griglia georgiana della finestra - Schroeven voor raamverdeling - Kruvi ukse petteliistule		6	2.5x20	
HS16	Screw for door jamb - Schraube für Türrahmen - Vis de fixation partie haute avec montants du cadre de porte - Viti x fissaggio montanti porte - Schroef voor deurkozijn - Kruvi ukse lengile		4	5x90	
HS25	Screw for doorstep - Schrauben für swelle - Vis pour fixation barre de seuil - Vite per soglia della porta - Schroef voor deurdorpel - Kruvi lävepakule		2	4.5x65	
TL4	Door handle fittings - Türgriff - Poignée de porte - Maniglie - Deurhendel / klink - Ukse käepide VU		1		
TL5	Set of door lock covers - Schlossblenden - Set de garnitures de porte - Copertura serrature - Slot sluitplaat set - Ukse lukuplaat		1		
	Cylinder lock - Zylinderschloss - Barillet de porte - Serratura - Cylinder slot - Ukse lukusüdamik		1	30x35	
	Male bolt hinge for door - Türband - Partie male de paumelle de porte - Cerniera anube x porta - Scharnier bout - Ukse polthing isane		3		
HC	Covers for door hinges - Schutzkappe für Türband - Couverture de paumelle de porte - Copertura delle cerniere della porta - Afdek kap voor deurscharnier - Reguleeritava polthinge kate		6		

Pos	27.03.2018	Piece list - Stückliste - Liste des pièces - Elementi - Stuklijst - Tükítabel 2658x1957 3UK.1.100.TPVP.MMc DGP+	1/2	Q	P (mm)	L (mm)
		Glass size - Glasgröße - Taille de la vitre - Misura del vetro - Glas afmeting - Klaasi mõõt: 514x1593 mm				
						
FS2	Window handle fittings - Fenstergriff - Poignée de fenetre - Maniglia c/ferramenta - Raamhendel -/grendel -/klink - Aknalink			2		
HS12	Screw for door covering moulding - Schrauben für deckungsprofil - Vis de fixation profils de finition verticaux a fixer a l'exterieur du cadre de la porte - Viti per fissaggio profili di finitura verticali delle porte - Schroeven voor deurafdekljst - Kruvi tuulelaudadele			10	4x40	
HS4	Screw for door fillet - Schraube zur befestigung türleiste - Vis pour fixation baguette d'arret de porte - Viti per massellino della porta - Schroef voor deurljst - Kruvi ukse kokkuvaltsiliistule			5	3x30	
HS16	Screw for door jamb - Schraube für türrahmen - Vis de fixation partie haute avec montants du cadre de porte - Viti x fissaggio montanti porte - Schroef voor deurkozijn - Kruvi ukse lengile			8	5x90	
HS25	Screw for doorstep - Schrauben für swelle - Vis pour fixation barre de seuil - Vite per soglia della porta - Schroef voor deurdorpel - Kruvi lävepakule			3	4.5x65	
MH	Male bolt hinge for door - Türband - Partie male de paumelle de porte - Cerniera anube x porta - Scharnier bout - Reguleeritav polthing isane			6	14x80	
HC	Covers for door hinges - Schutzkappe für türband - Couverture de paumelle de porte - Copertura delle cerniere della porta - Afdek kap voor deurscharnier - Reguleeritava polthinge kate			12		
TL4	Door handle fittings - Türgriff - Poignée de porte - Maniglie - Deurhendel / klink - Ukse käepide			1		
TL5	Set of door lock covers - Schlossblenden - Set de garnitures de porte - Copertura serrature - Slot sluitplaat set - Ukse lukuplaat			1		
	Cylinder lock - Zylinderschloss - Barillet de porte - Serratura - Cylinder slot - Ukse lukusüdamik			1	30x35	
	Striker for barrel bolt - Hülse für grendelriegel - Gache au sol du targette - Boccola per fermo della porta - Huls voor vergrendelingsschuif - Vasturaud ukse servariivile			2		

