

Domeo 3 Loggia
Art. Nr. 4425819
1/34



11.07.2023

Art. Nr. 4425819

Grundplan - Grundplan - Plan de masse -
Planimetria - Plattegrond - Põhiplaan

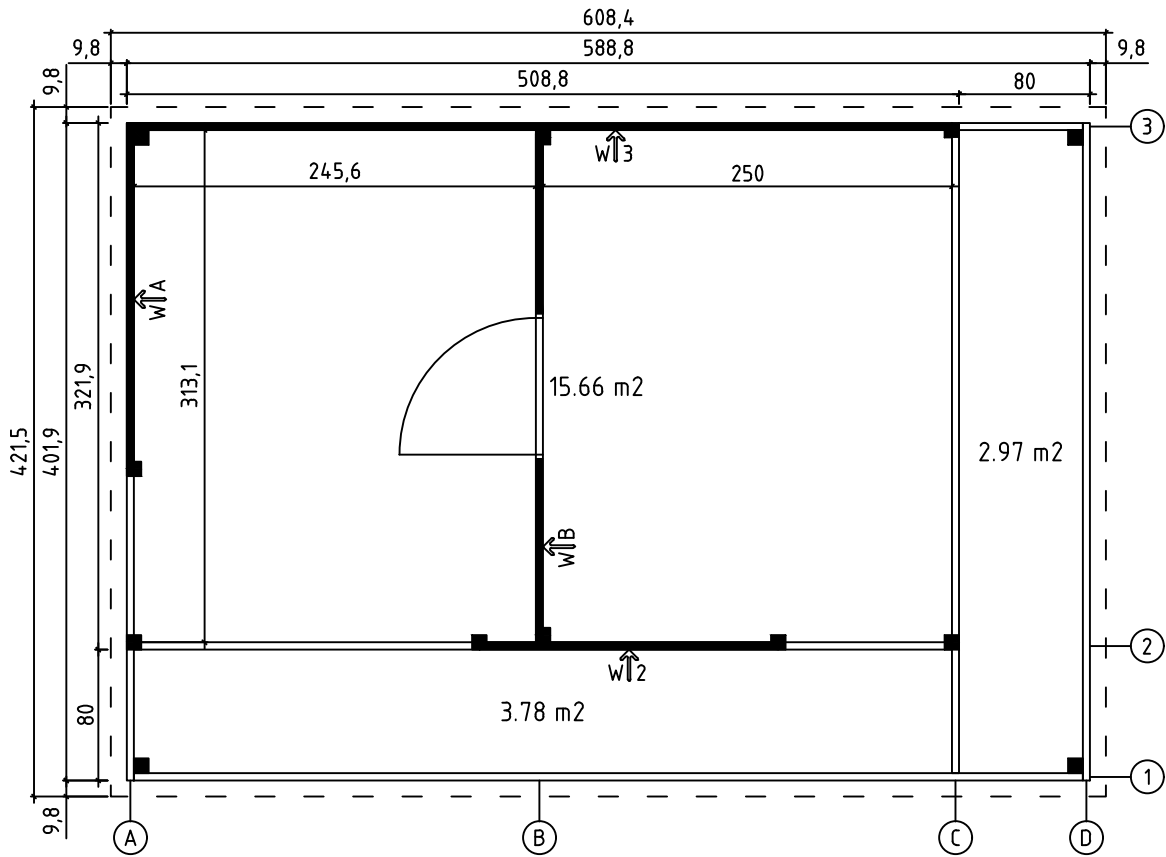

Foundation - Fundament - Fondation - Fondamenta - Fundering -
Immutatud alusraam

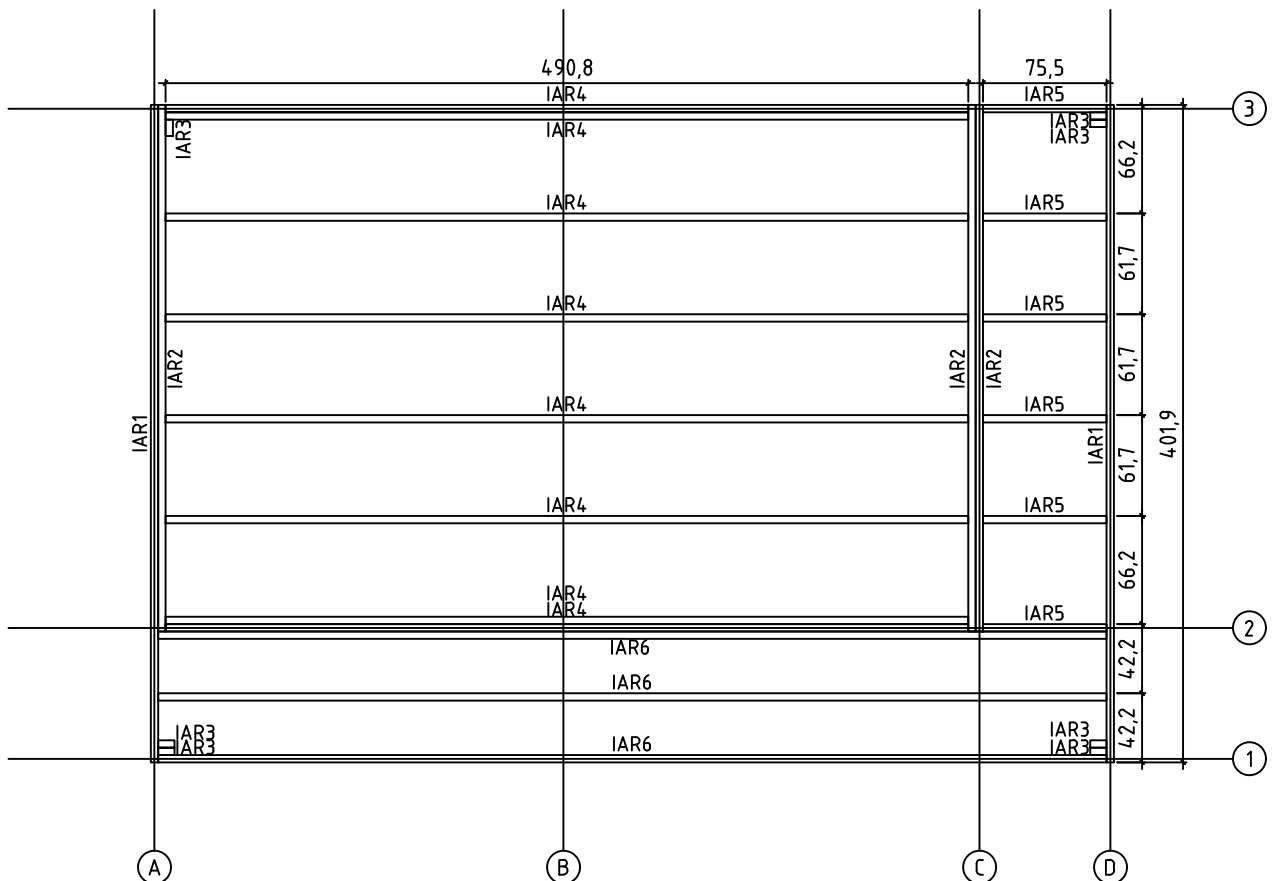

Art. Nr. 4425819

Floor boards - Fussbodenbretter - Plan pose plancher - Pavimento -
Vloerhout - Põrandalaudis

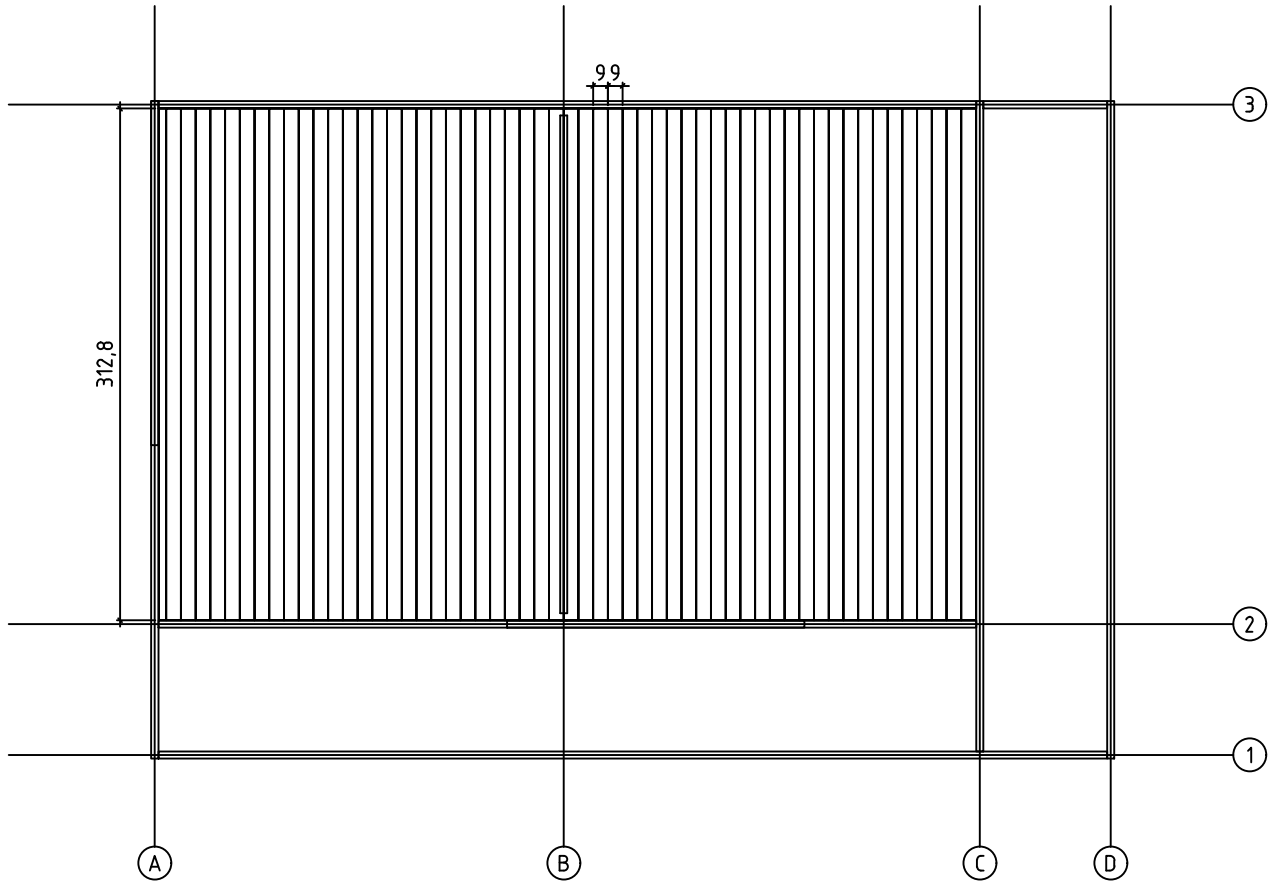

Terrace boards - Terrassenbretter - Plancher de terrasse -
Piattaforme terrazzo - Terrassvloer - Terrassilaudis

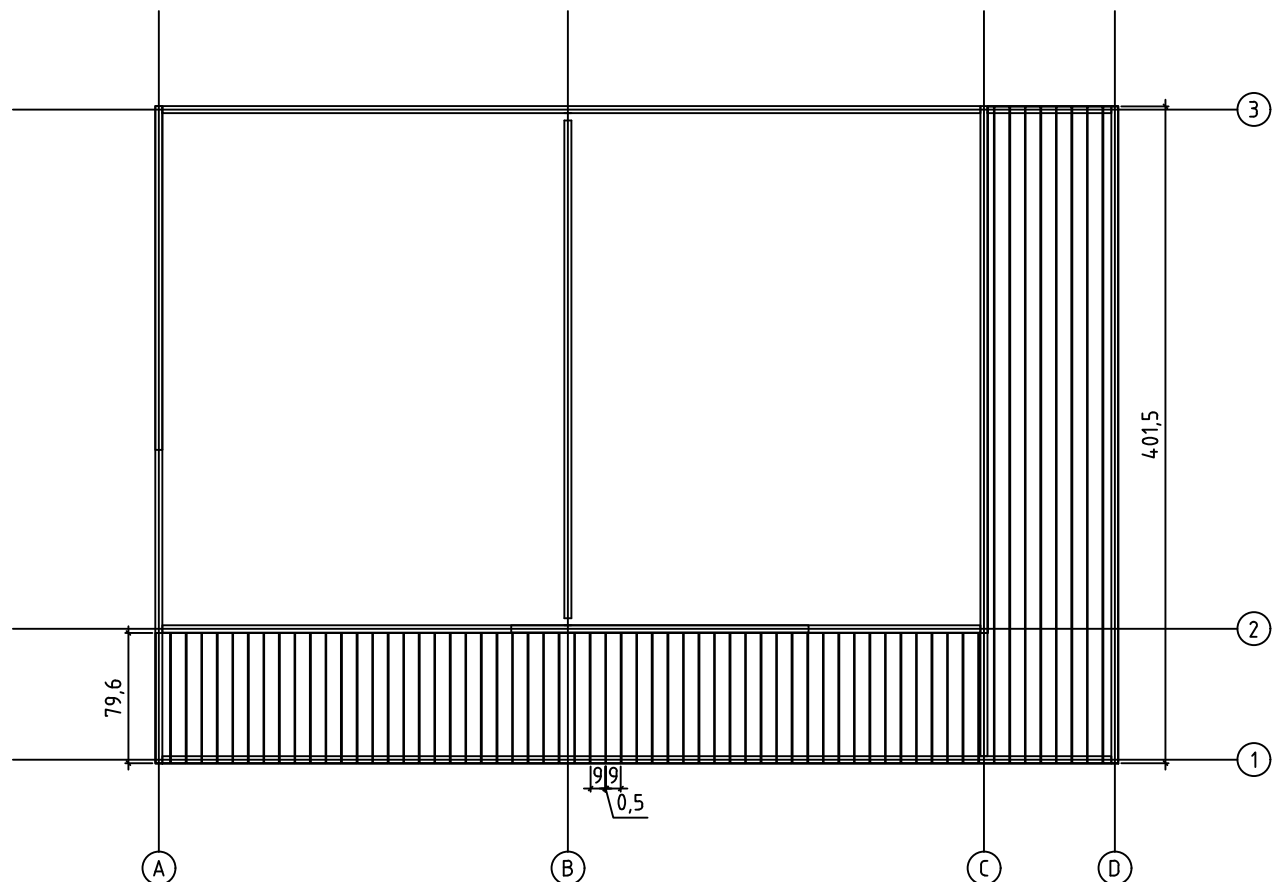

11.07.2023

3/34



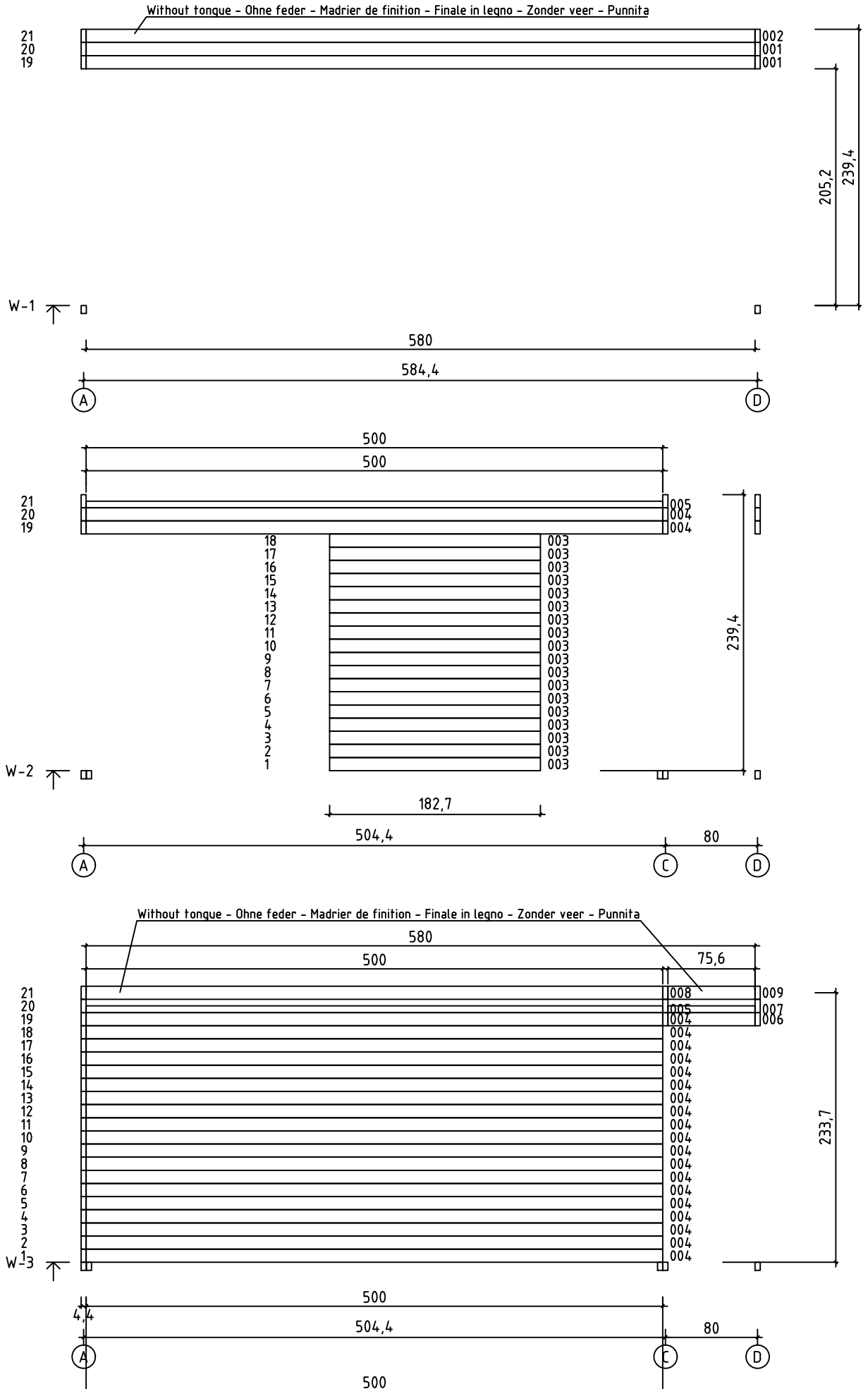

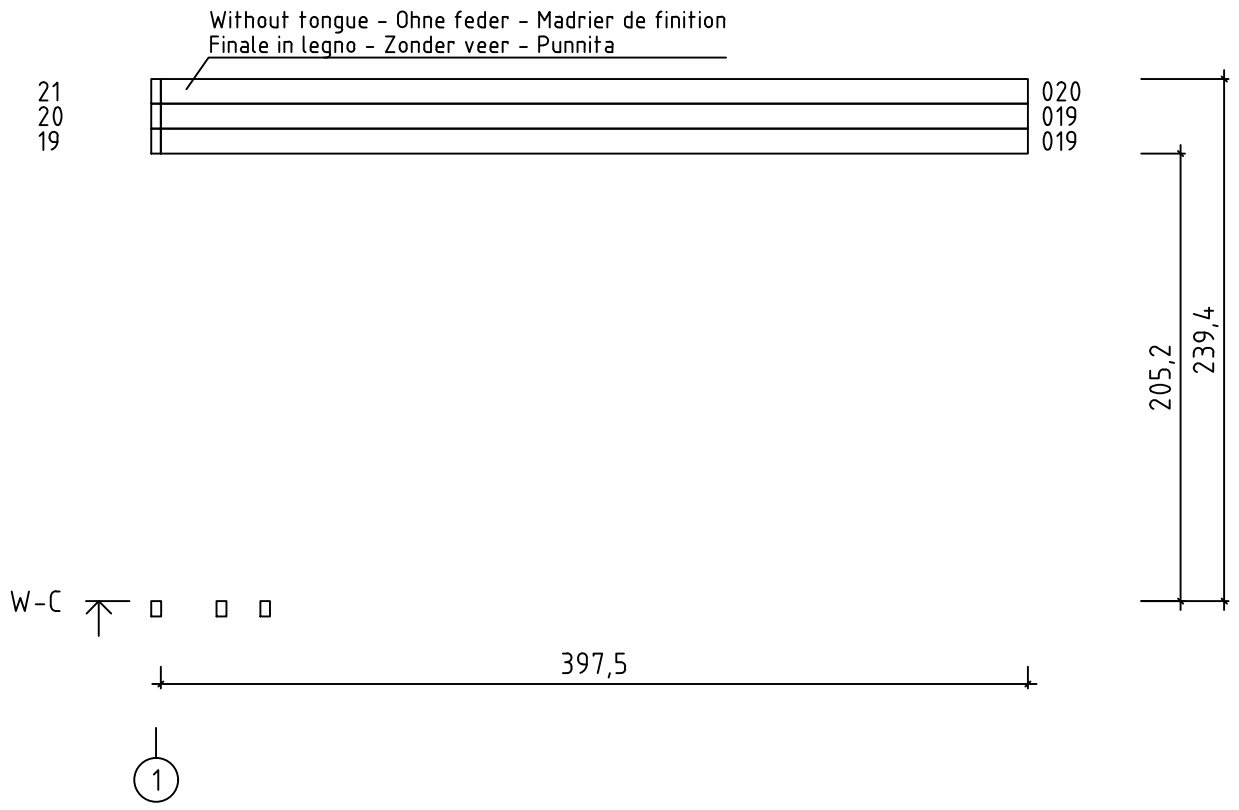
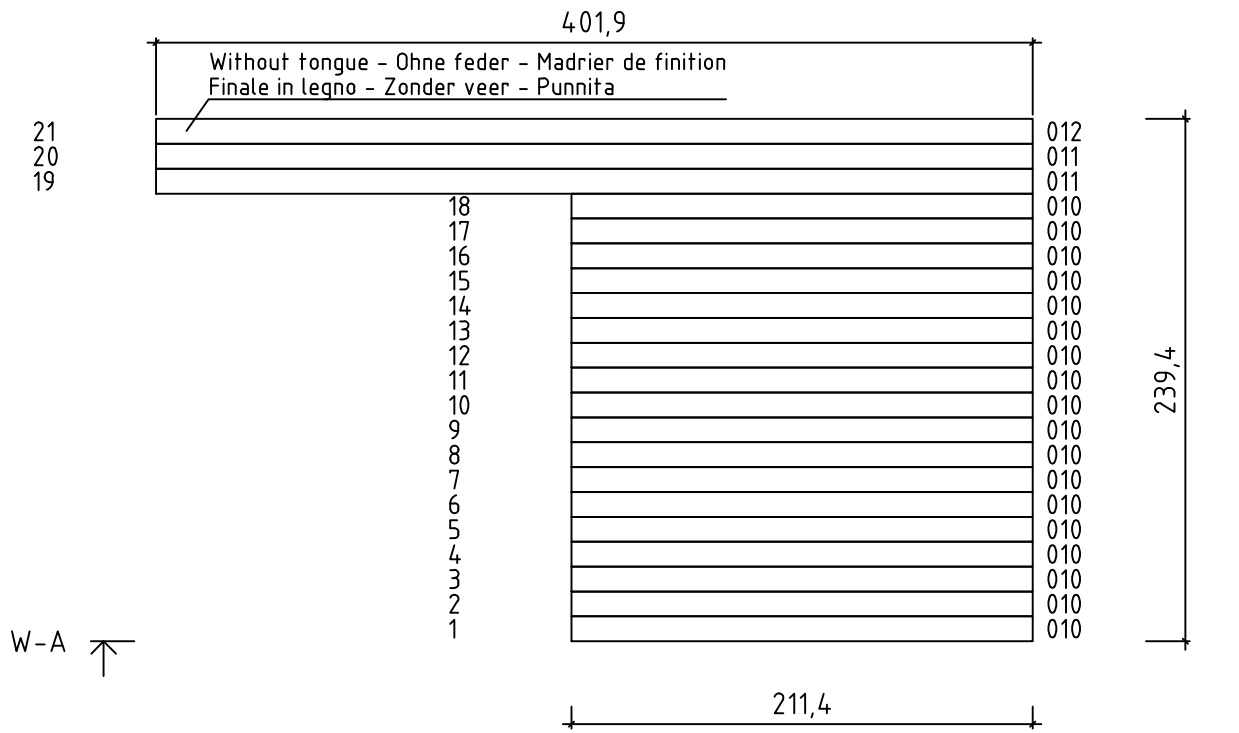



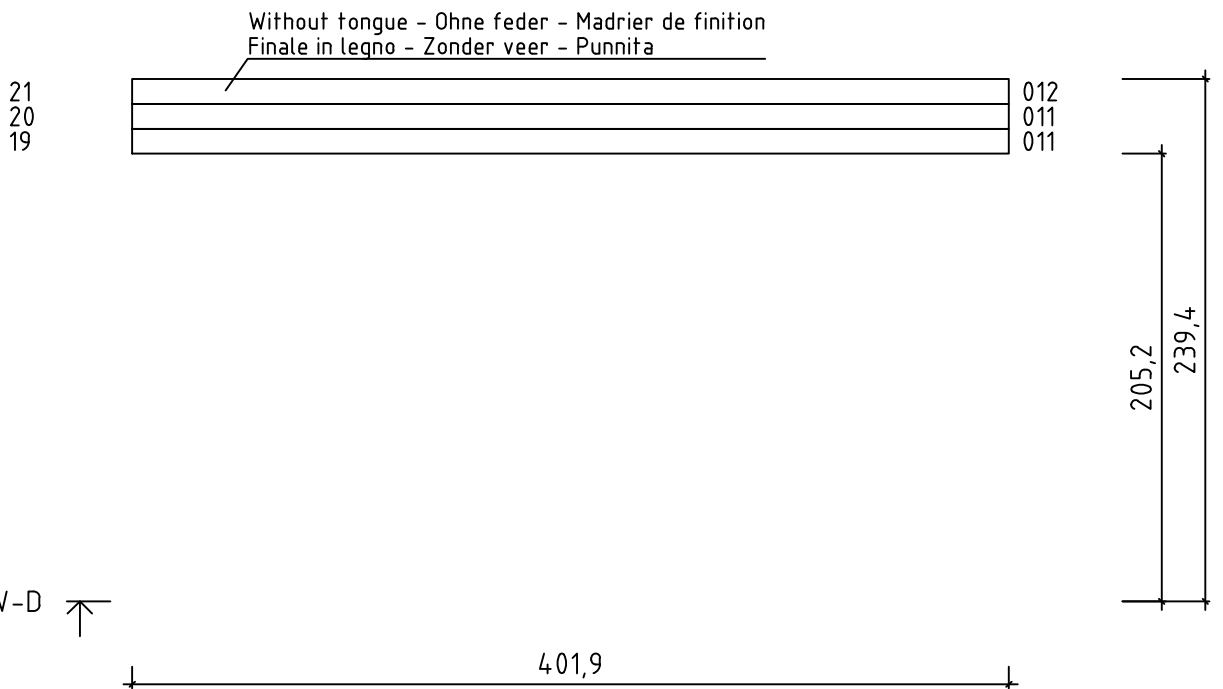
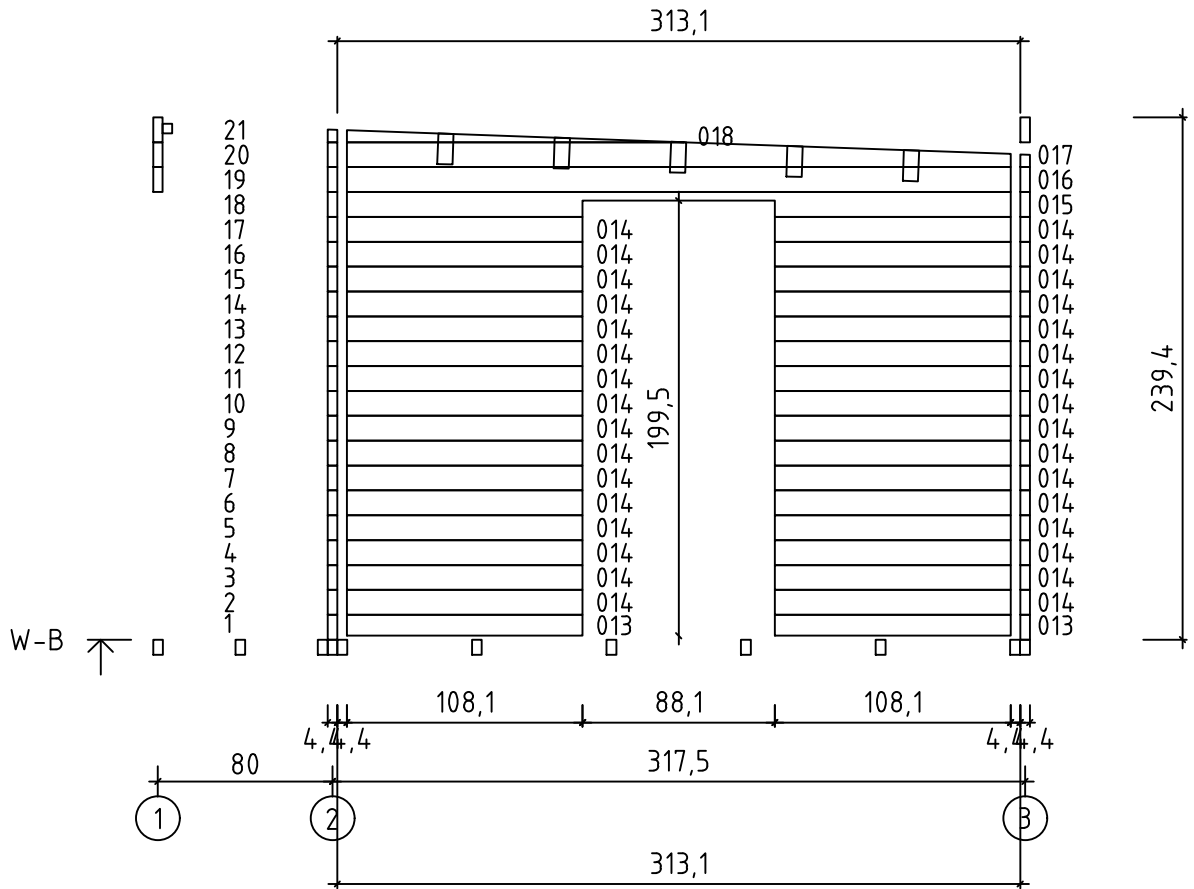

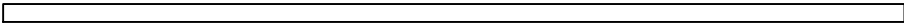
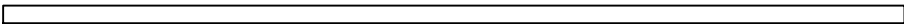

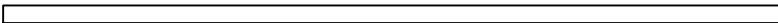
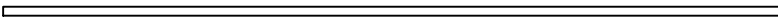
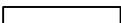
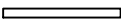
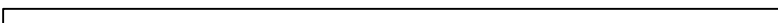
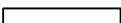
Art. Nr. 4425819



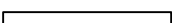

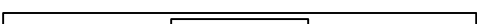
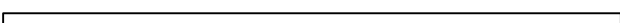
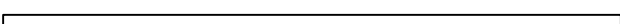
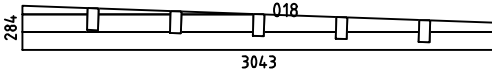

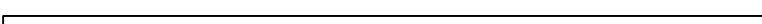
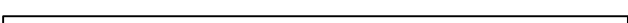

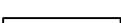





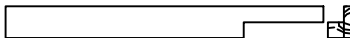

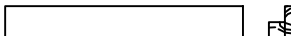
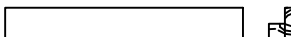
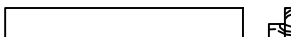



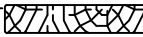
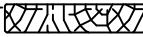













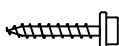





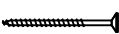



Art. Nr. 4425819



Pos	11.07.2023 Piece list - Stückliste - Liste des pièces - Elementi - Stuklijst - Tükitalabel Art. Nr. 4425819 7/34	Q	P (mm)	L (mm)
001		2	44x114	5800
002		1	44x114	5800
003		18	44x114	1827
004		21	44x114	5000
005		2	44x57	5000
006		1	44x114	756
007		1	44x57	756
008		1	44x114	5000
009		1	44x114	756
010		18	44x114	2114
011		4	44x114	4019
012		2	44x114	4019
013		2	44x96	1081
014		32	44x114	1081
015		1	44x114	3043
019		2	44x114	3975
020		1	44x114	3975
WB-1		1		
	Foundation - Fundament - Fondation - Fondamenta - Fundering - Immutatud alusraam			
IAR6		3	45x70	5798
	Foundation - Fundament - Fondation - Fondamenta - Fundering - Immutatud alusraam			
IAR4		8	45x70	4908
	Foundation - Fundament - Fondation - Fondamenta - Fundering - Immutatud alusraam			
IAR1		2	45x70	4019
	Foundation - Fundament - Fondation - Fondamenta - Fundering - Immutatud alusraam			
IAR2		3	45x70	3219
	Foundation - Fundament - Fondation - Fondamenta - Fundering - Immutatud alusraam			
IAR5		6	45x70	755

Pos	11.07.2023 Piece list - Stückliste - Liste des pièces - Elementi - Stuklijst - Tükítabel Art. Nr. 4425819 8/34	Q	P (mm)	L (mm)
IAR3	Foundation - Fundament - Fondation - Fondamenta - Fundering - Immutatud alusraam 	7	45x70	100
RV1	Lath - Pfetten - Liteau - Piccola asse - Gordingen - Roov 	1	44x44	4956
RV2	Lath - Pfetten - Liteau - Piccola asse - Gordingen - Roov 	1	44x44	712
A-PR1	Roof beam - Dachbalken - Panne de toit - Perlina del tetto - Gordingen / dakbalk - Pärlin 	5	70x140	4993
A-PR2	Roof beam - Dachbalken - Panne de toit - Perlina del tetto - Gordingen / dakbalk - Pärlin 	6	70x140	748
	Floor boards - Fussbodenbretter - Lame de plancher - Pavimento - Vloerhout - Põrandalaud 	56	90x18	3128
	Terrace boards - Terrassenbretter - Plancher de terrasse - Piattaforme terrazzo - Terrasvloer - Terrassilaud 	9	90x19	4015
	Terrace boards - Terrassenbretter - Plancher de terrasse - Piattaforme terrazzo - Terrasvloer - Terrassilaud 	53	90x19	796
	Roof boards - Dachbretter - Voliges - Perlina per tetto - Dakhout - Katuselaud 	65	90x18	4050
	Floor fillet - Fussbodenleiste - Corniere de finition du plancher - Finitura per pavimento (battisco pa) - Vloerafwerkljst - Põrandaliist 		18x18	25
DL3	Corner fillet - Deckleiste - Profils de finition angles a l'exterieur - Massello d'angolo - (hoek)lijst - Nurgaliist 	1	18x120	2200
DPL1	Roofing felt fillet - Dachpappenleiste - Baguette de fixation du feutre bitumeux - Asse per fissaggio guaina bituminosa - Afdekljst asfaltpapier - Katusepapiliist 	4	18x58	3042
DPL2	Roofing felt fillet - Dachpappenleiste - Baguette de fixation du feutre bitumeux - Asse per fissaggio guaina bituminosa - Afdekljst asfaltpapier - Katusepapiliist 	2	18x58	4100
FF6	Fixing fillet - Fixirungsleiste - Profil de fixation - Massello di fissaggio - Bevestiging lijstwerk - Tenderliist 	1	11x30	2998
DL1	Corner fillet - Deckleiste - Profils de finition angles a l'exterieur - Massello d'angolo - (hoek)lijst - Nurgaliist 	1	18x70	2205
DL2	Corner fillet - Deckleiste - Profils de finition angles a l'exterieur - Massello d'angolo - (hoek)lijst - Nurgaliist 	1	18x70	2315
RS3	Railing strip - Begrenzungsleiste - Rembarde - Sbarra - Afscheidingslijst - Piirdelaud 	2	18x70	1993
RS4	Railing strip - Begrenzungsleiste - Rembarde - Sbarra - Afscheidingslijst - Piirdelaud 	1	18x70	2000
RS5	Railing strip - Begrenzungsleiste - Rembarde - Sbarra - Afscheidingslijst - Piirdelaud 	2	18x90	971
RS6	Railing strip - Begrenzungsleiste - Rembarde - Sbarra - Afscheidingslijst - Piirdelaud 	2	18x90	1075
RS7	Railing strip - Begrenzungsleiste - Rembarde - Sbarra - Afscheidingslijst - Piirdelaud 	1	18x90	2022
RS8	Railing strip - Begrenzungsleiste - Rembarde - Sbarra - Afscheidingslijst - Piirdelaud 	1	18x90	2126
RS11	Railing strip - Begrenzungsleiste - Rembarde - Sbarra - Afscheidingslijst - Piirdelaud 	1	18x90	3039

Pos	11.07.2023 Piece list - Stückliste - Liste des pièces - Elementi - Stuklijst - Tükítabel Art. Nr. 4425819 9/34	Q	P (mm)	L (mm)
RS12	Railing strip - Begrenzungsleiste - Rembarde - Sbarra - Afscheidingslijst - Piirdelaud 	1	18x90	3059
FL	Post - Pfosten - Poteau - Piede registrabile - Stijl - Post 	2	44x44	310
P1	Post - Pfosten - Poteau - Piede registrabile - Stijl - Post 	2	88x88	2330
P2	Post - Pfosten - Poteau - Piede registrabile - Stijl - Post 	1	88x88	2223
P2a	Post - Pfosten - Poteau - Piede registrabile - Stijl - Post 	1	88x88	2223
CP	Post - Pfosten - Poteau - Piede registrabile - Stijl - Post 	3	88x88	2052
EP1	Post - Pfosten - Poteau - Piede registrabile - Stijl - Post 	1	88x88	2205
EP2	Post - Pfosten - Poteau - Piede registrabile - Stijl - Post 	1	88x88	2315
EP3	Post - Pfosten - Poteau - Piede registrabile - Stijl - Post 	1	70x70	2033
P3	Post - Pfosten - Poteau - Piede registrabile - Stijl - Post 	1	90x90	2205
P4	Post - Pfosten - Poteau - Piede registrabile - Stijl - Post 	1	90x90	2220
P5	Post - Pfosten - Poteau - Piede registrabile - Stijl - Post 	2	90x90	2300
TB1	Fascia board - Traufbrett - Bandeau de toit - Finitura lati tetto - Gevellijst - Räästalaud 	4	18x120	3042
TB2	Fascia board - Traufbrett - Bandeau de toit - Finitura lati tetto - Gevellijst - Räästalaud 	2	18x120	4179
	Fascia sheet - Abschlussprofil - Profil de finition métallique pour débord de toiture - Scossalina di protezione dall'acqua per bordo di legno - Afdek profil / boordprofiel - Räästaplekk 	4		2200
	Fascia sheet - Abschlussprofil - Profil de finition métallique pour débord de toiture - Scossalina di protezione dall'acqua per bordo di legno - Afdek profil / boordprofiel - Räästaplekk 	4		3100
DRV1	Roof edge reinforcement - Dachrandverstärkung - Corniere de renfort de bord de toit - Rinforzo x tetto - Dakrand versterking - Räästatugevdus 	4	80x44	2944
DRV2	Roof edge reinforcement - Dachrandverstärkung - Corniere de renfort de bord de toit - Rinforzo x tetto - Dakrand versterking - Räästatugevdus 	2	80x44	4179
FF2	Fixing fillet - Fixierungsleiste - Profil de fixation - Massello di fissaggio - Bevestiging lijstwerk - Tenderliist 	2	15x45	2026
FF9	Fixing fillet - Fixierungsleiste - Profil de fixation - Massello di fissaggio - Bevestiging lijstwerk - Tenderliist 	2	18x44	1967
FF	Fixing fillet - Fixierungsleiste - Profil de fixation - Massello di fissaggio - Bevestiging lijstwerk - Tenderliist 	2	18x44	2030
FF3	Fixing fillet - Fixierungsleiste - Profil de fixation - Massello di fissaggio - Bevestiging lijstwerk - Tenderliist 	1	38x46	1980
FF7	Fixing fillet - Fixierungsleiste - Profil de fixation - Massello di fissaggio - Bevestiging lijstwerk - Tenderliist 	1	38x46	2998

Pos	11.07.2023 Piece list - Stückliste - Liste des pièces - Elementi - Stuklijst - Tükítabel Art. Nr. 4425819	10/34	Q	P (mm)	L (mm)
HS8	Screw for corner fillet - Schraube zur befestigung deckleiste - Vis pour profils de finition angles a l'exterieur - Viti per massellino d'angolo - Schroef voor afdeklijst (hoek) - Kruvi nurgaliistudele		20	3.5x35	
HS32	Screw for door jamb - Schraube für türrahmen - Vis de fixation partie haute avec montants du cadre de porte - Viti x fissaggio montanti porte - Schroef voor deurkozijn - Kruvi ukse lengile		14	4.5x25	
HS15	Screw for fascia sheet - Schraube für abschlussprofil - Vis pour profil de finition métallique pour débord de toiture - Viti per fissare i folgi di gronda - Schroef voor afsluit (afdek)profiel - Tornillo de tejado - Katusekruvi		120	4.8x25	
HS14	Screw for wall details - Schraube für wand details - Vis pour mur details - Viti per elementi della porta - Schroef voor wand details - Kruvi seinte montaažiks		420	5x80	
HS12	Screw for doorstep - Schrauben für swelle - Vis pour fixation barre de seuil - Vite per soglia della porta - Schroef voor deurdeurpel - Kruvi lävepakule		7	4x40	
HS12	Screw for metal corner - Holzschraube für metallwinkel - Vis de fixation des cornieres en métal - Viti per fissare suadretta di metallo di giunzione - Schroef voor metalen hoek - Kruvi nurgikule		66	4x40	
HS12	Screw for fascia boards - Schrauben für traufbretter - Vis pour fixation bandeau de toit - Viti x striscia del tetto - Schroef voor gevellijst - Kruvi räästalauale		40	4x40	
HS12	Screw for beam holder - Schrauben für balkenhalter - Vis de fixation support "u" galvanisé - Vite per trave di sostegno - Schroef voor bevestiging balkhouder (gordingschoen) - Kruvi talakingale		240	4x40	
HS12	Screw for fixing fillet of door and window - Schrauben für fixierungleiste - Vis pour profil vertical de fixation pour ouvertures des fenetres et portes - Viti per massello di fissaggio - Schroeven voor bevestiging van deur en raam lijsten - Kruvi tenderliistudele		90	4x40	
HS12	Screw for covering moulding - Schrauben für deckungsprofil - Vis de fixation profils horizontaux haut inférieur et extérieur d'encadrement de porte - Vite per cornice di copertura - Schroef voor afdekprofiel - Kruvi piirdetauale		64	4x40	
HS12	Screw for door jamb - Schraube für türrahmen - Vis de fixation partie haute avec montants du cadre de porte - Viti x fissaggio montanti porte - Schroef voor deurkozijn - Kruvi ukse lengile		18	4x40	
HS18	Screw for post - Schrauben für pfosten - Vis de fixation des poteaux - Viti per inviare - Schroef voor stijlen - Kruvi postile		6	5x120	
HS18	Screw for roof beams - Schrauben für dachbalken - Vis pour fixation pannes de toit - Viti per perline del tetto - Schroef voor gordingen / dakbalken - Kruvi pärlinitele		5	5x120	
HS33	Screw for door jamb - Schraube für türrahmen - Vis de fixation partie haute avec montants du cadre de porte - Viti x fissaggio montanti porte - Schroef voor deurkozijn - Kruvi ukse lengile		20	5x40	
HS16	Screw for foundation - Schrauben zur befestigung fundament - Vis de fixations des poutrelles de fondations - Viti x fondamenta - Schroef voor fundering - Kruvi alusraamile		65	5x90	
HS16	Screw for post - Schrauben für pfosten - Vis de fixation des poteaux - Viti per inviare - Schroef voor stijlen - Kruvi postile		22	5x90	
HS16	Screw for roof edge reinforcement - Schrauben für dachrandverstärkung - Vis pour fixation corniere renfort de bord de toit - Viti x rinforzo bordo tetto - Schroef voor dakrand versterking - Kruvi räästatugevdusele		40	5x90	
HS16	Screw for wall details - Schraube für wand details - Vis pour mur details - Viti per elementi della porta - Schroef voor wand details - Kruvi seinadetailidele		20	5x90	
HS16	Screw for door jamb - Schraube für türrahmen - Vis de fixation partie haute avec montants du cadre de porte - Viti x fissaggio montanti porte - Schroef voor deurkozijn - Kruvi ukse lengile		18	5x90	
HS27	Screw for wall details - Schraube für wand details - Vis pour mur details - Viti per elementi della porta - Schroef voor wand details - Kruvi seinadetailile		18	6x120	
HS22	Screw for 1. wall beam - Schraube für 1. bohlenreihe - Vis de fixations 1ere rangée de madriers avec poutrelles de fondations - Vite fissaggio alle fondamenta - Schroef voor 1 wandbalk - Kruvi poollauale		8	6x150	
HS23	Screw for wall details - Schraube für wand details - Vis pour mur details - Viti per elementi della porta - Schroef voor wand details - Kruvi seinadetailidele		225	6x180	
HS21	Screw for rafter - Schrauben für dachsparren - Vis pour chevron - Vite per trave - Schroef voor dakspar - Kruvi sarikatele		10	6x80	

Art. Nr. 4425819

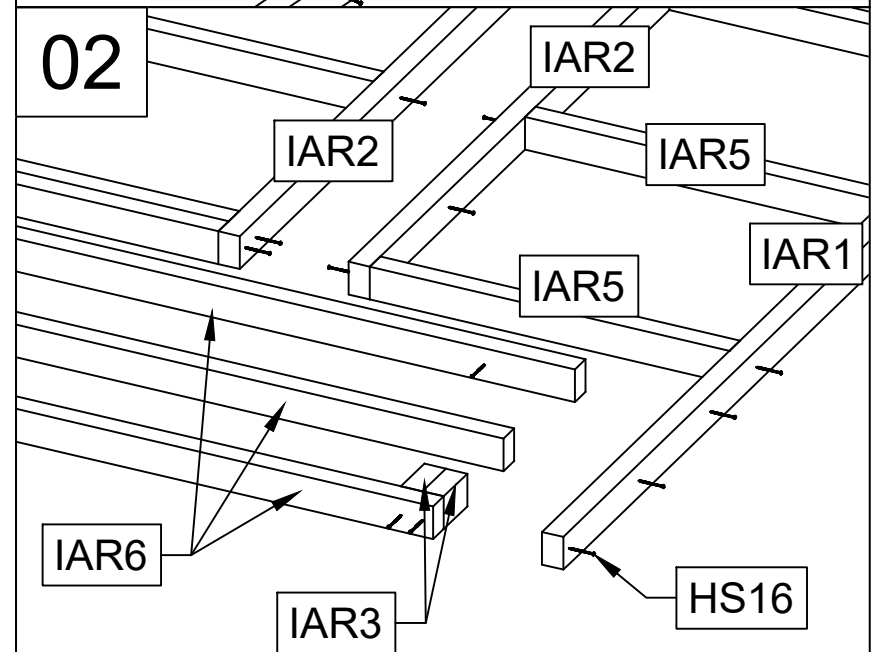
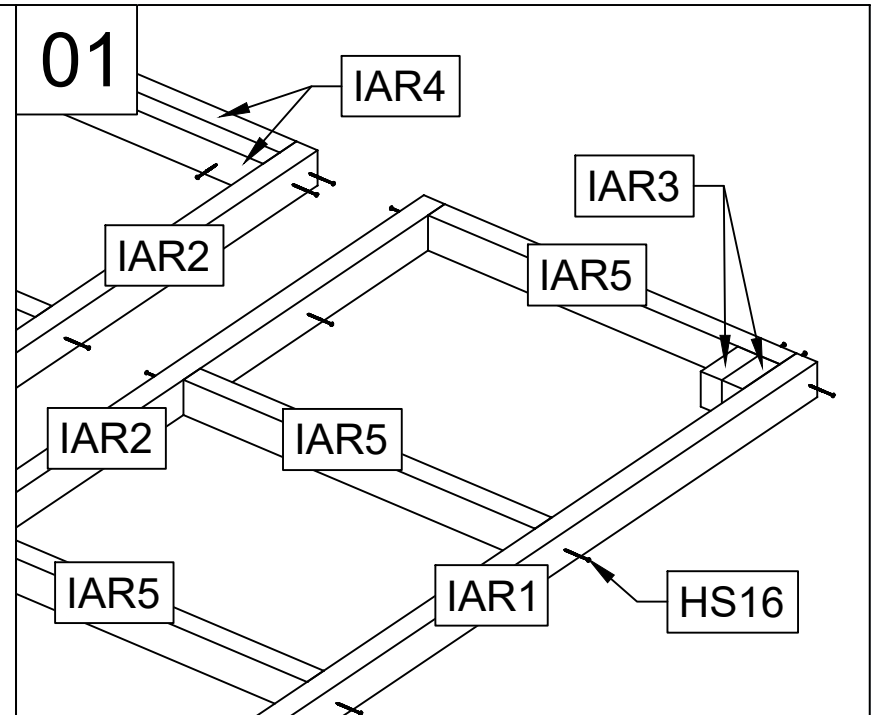

Art. Nr. 4425819

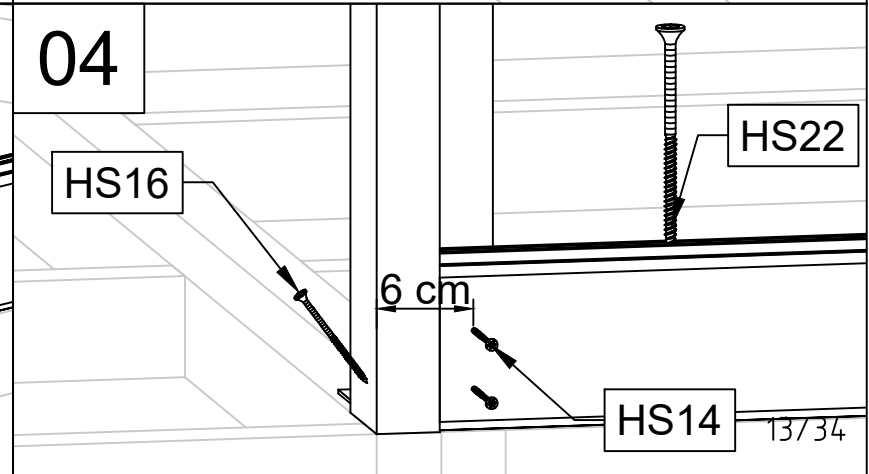
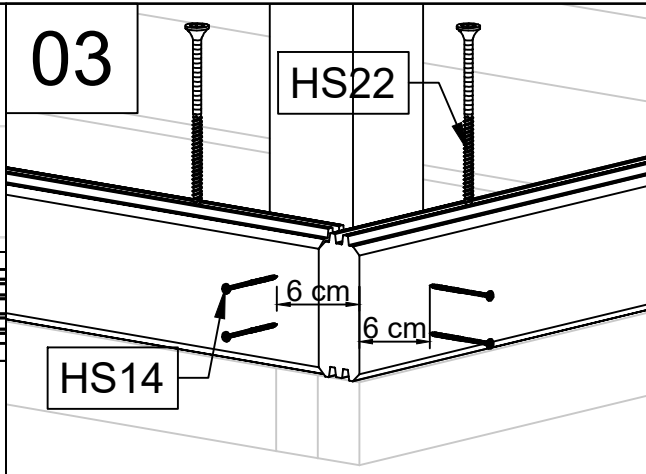
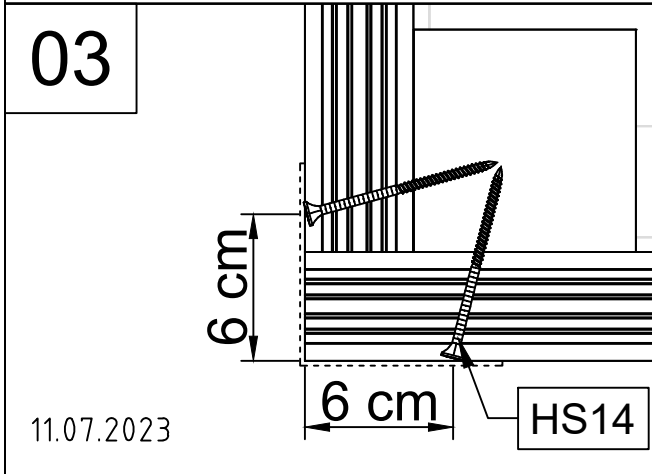
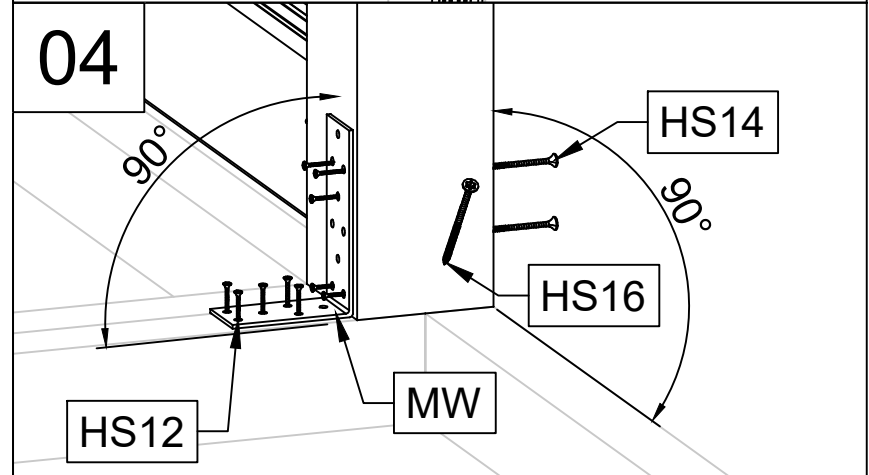
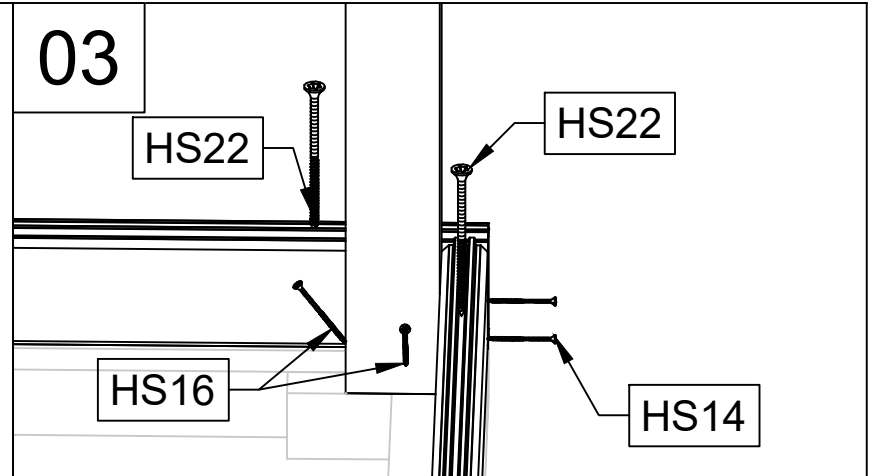
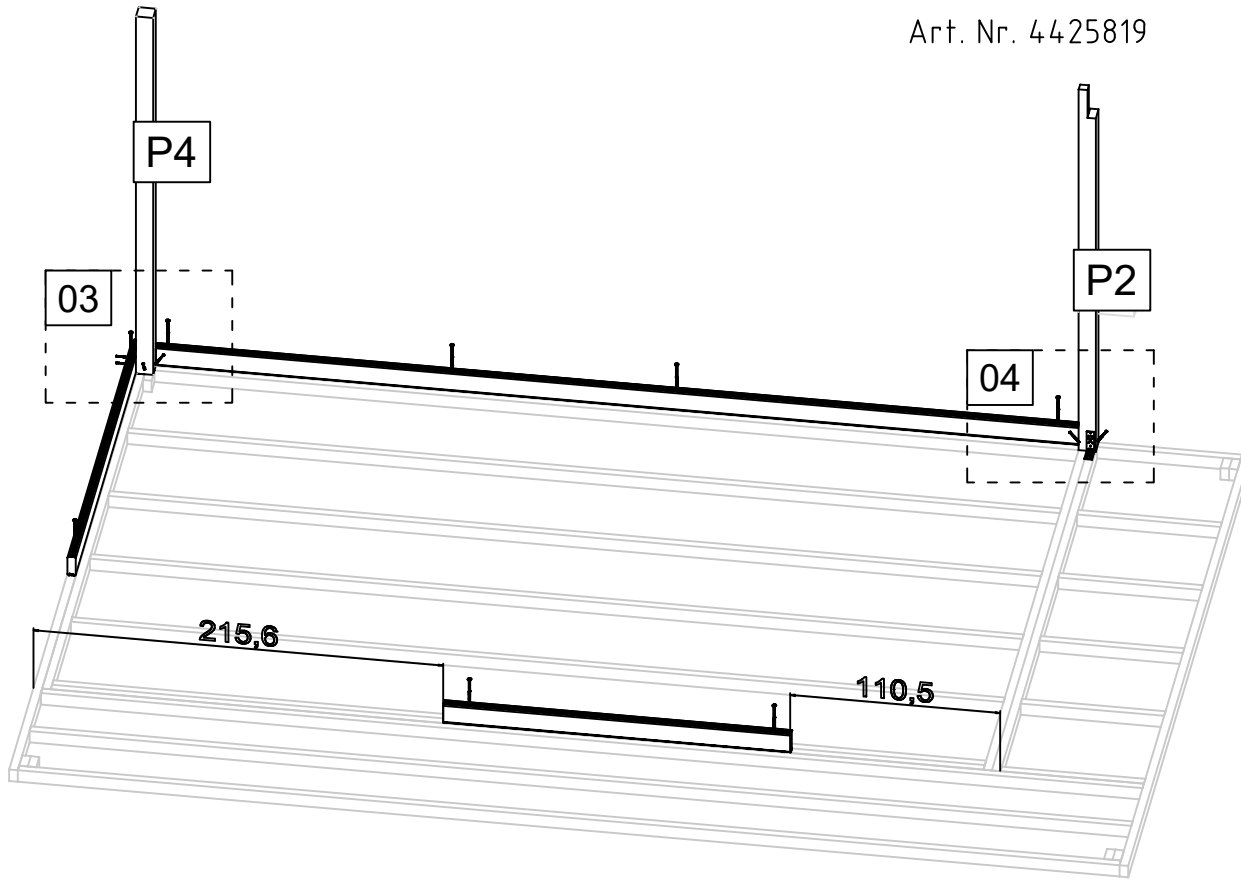

11.07.2023

13/34

Art. Nr. 4425819

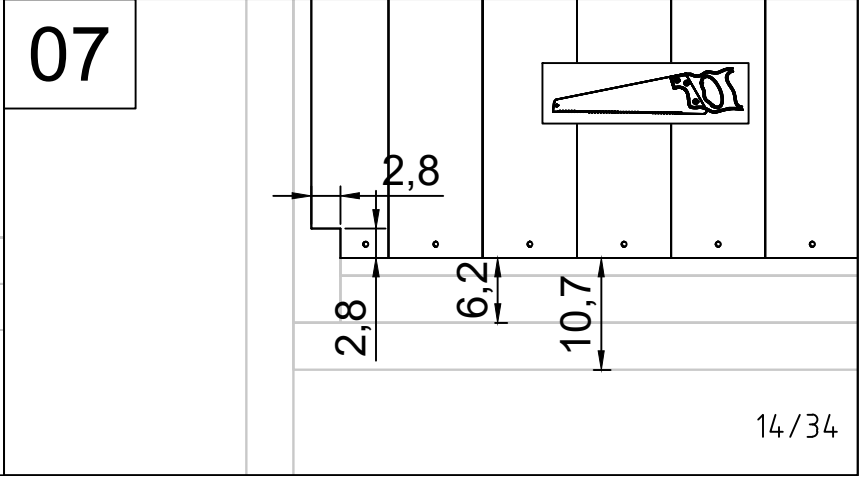
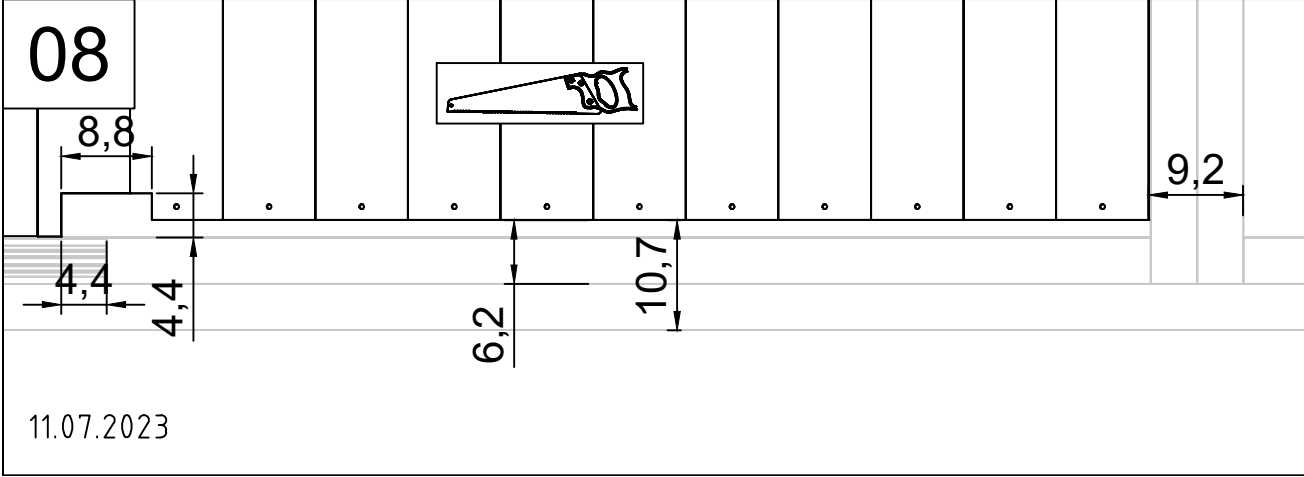
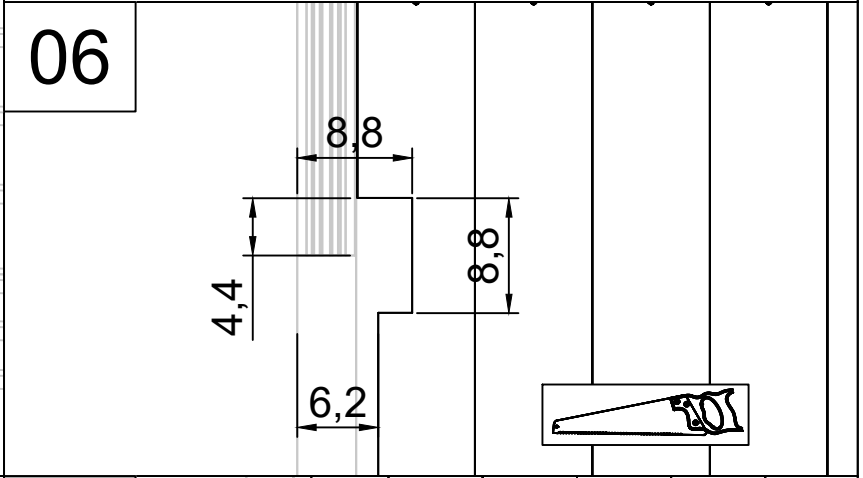
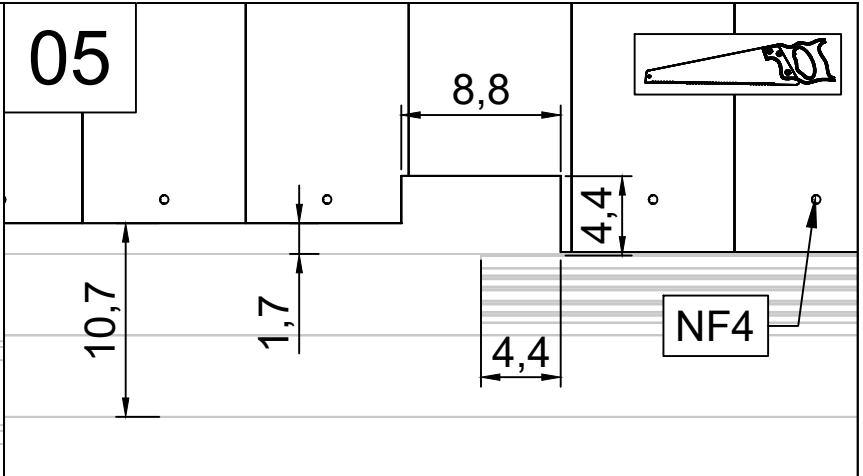
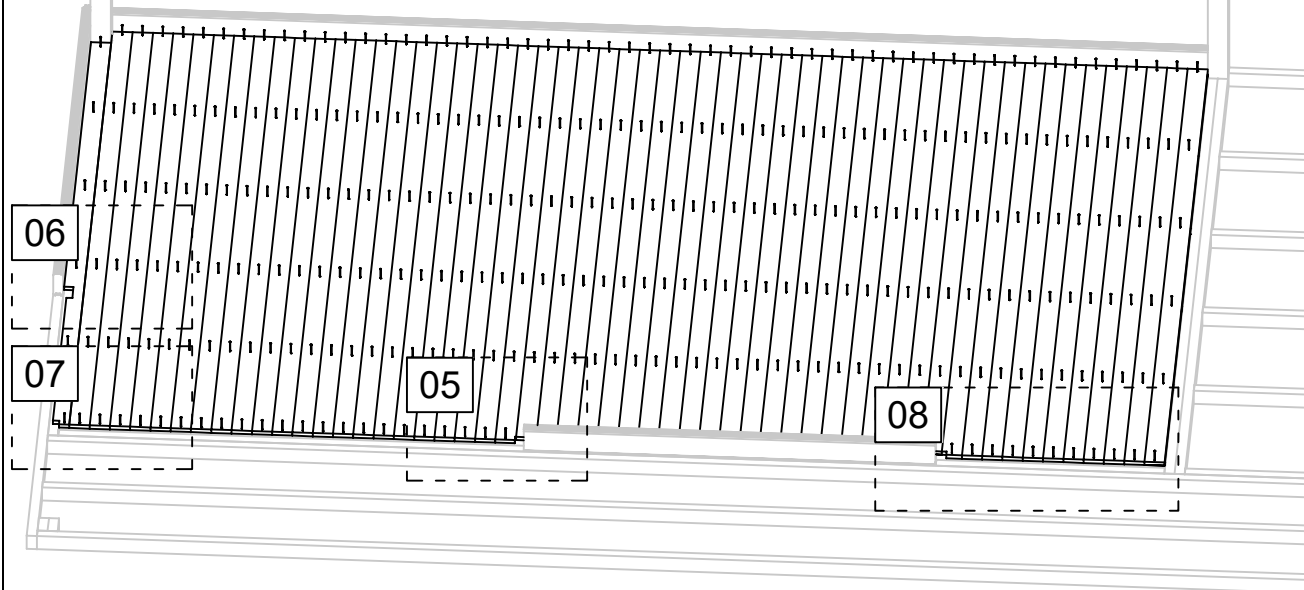

Art. Nr. 4425819

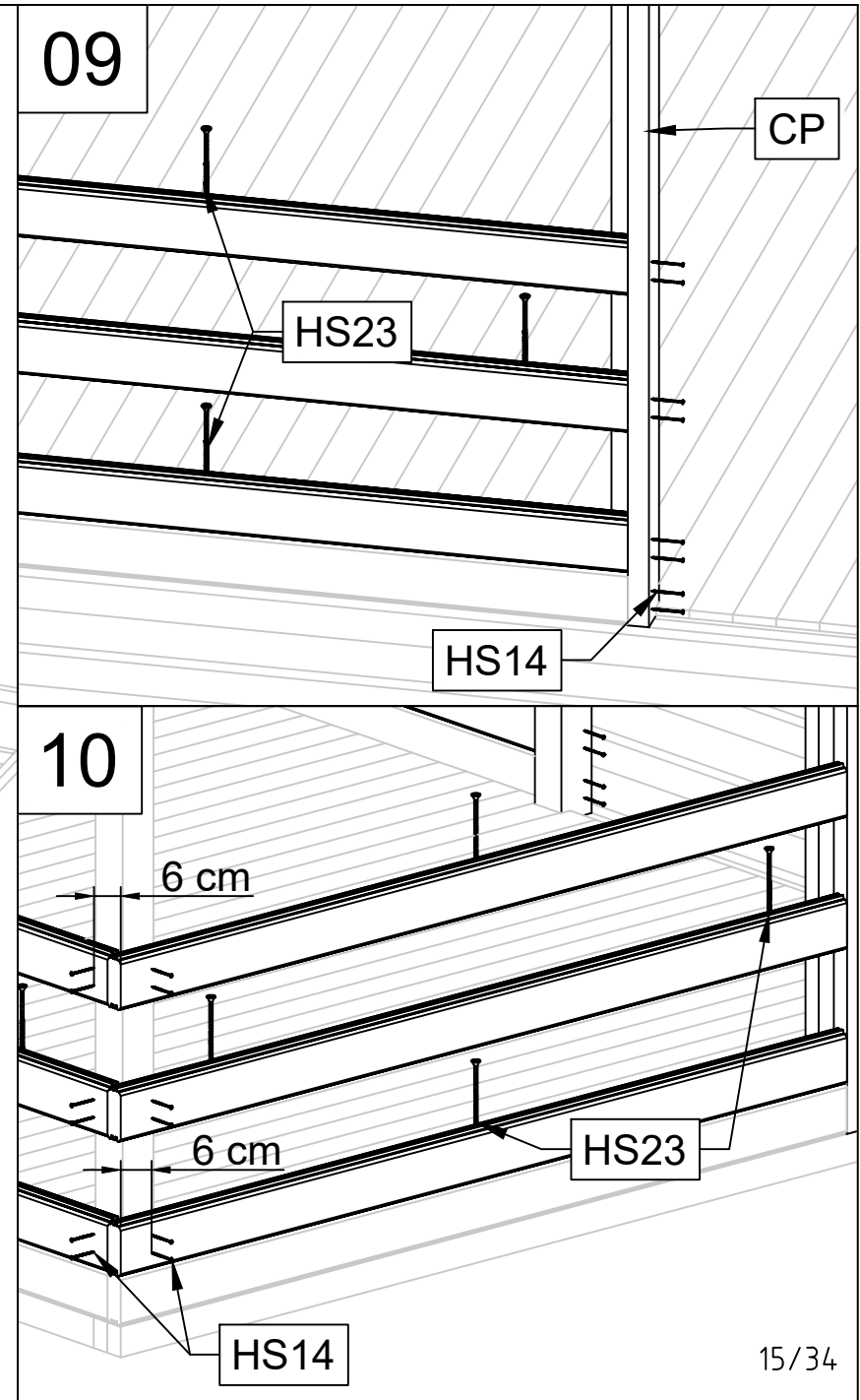
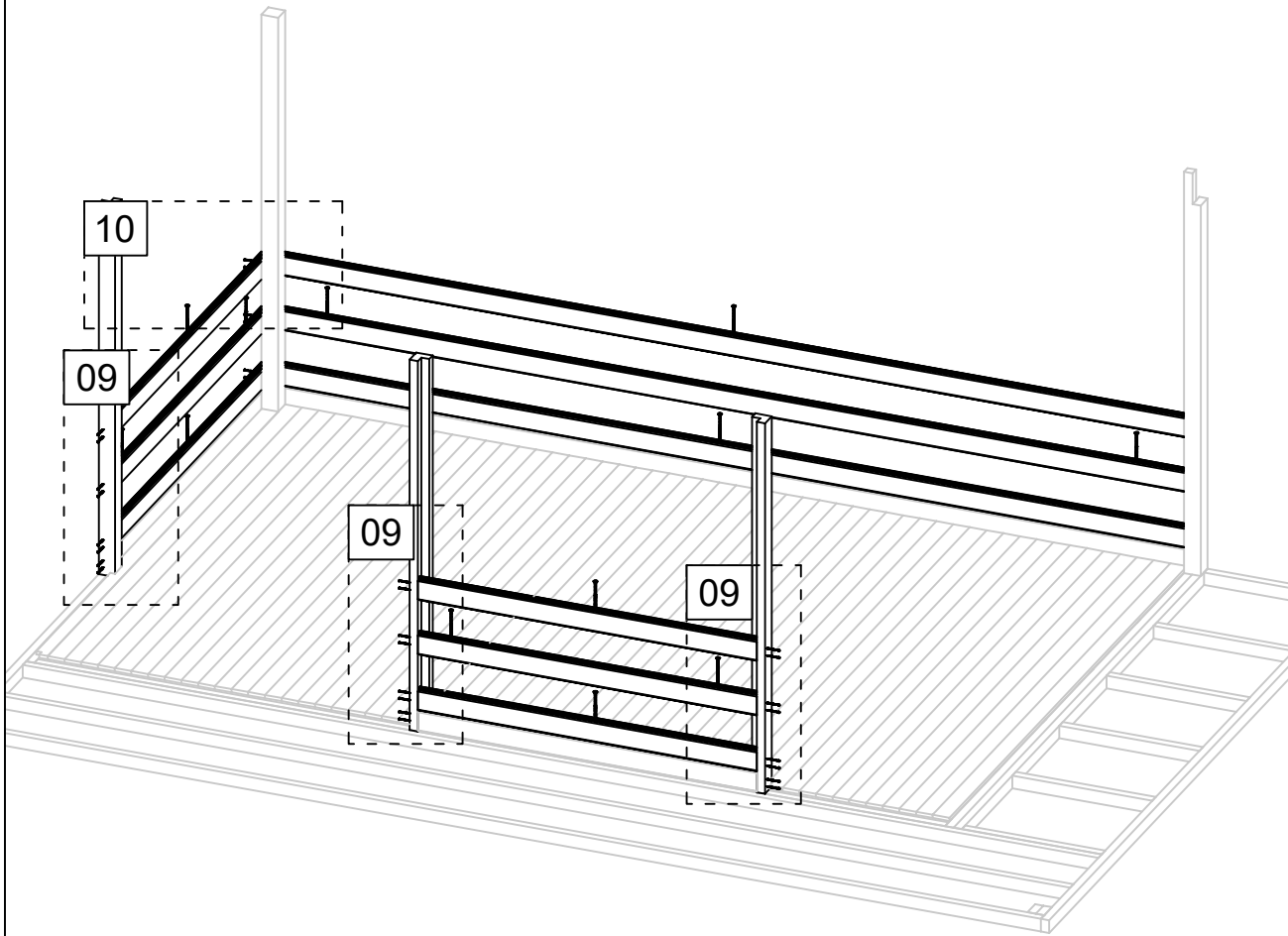

Art. Nr. 4425819

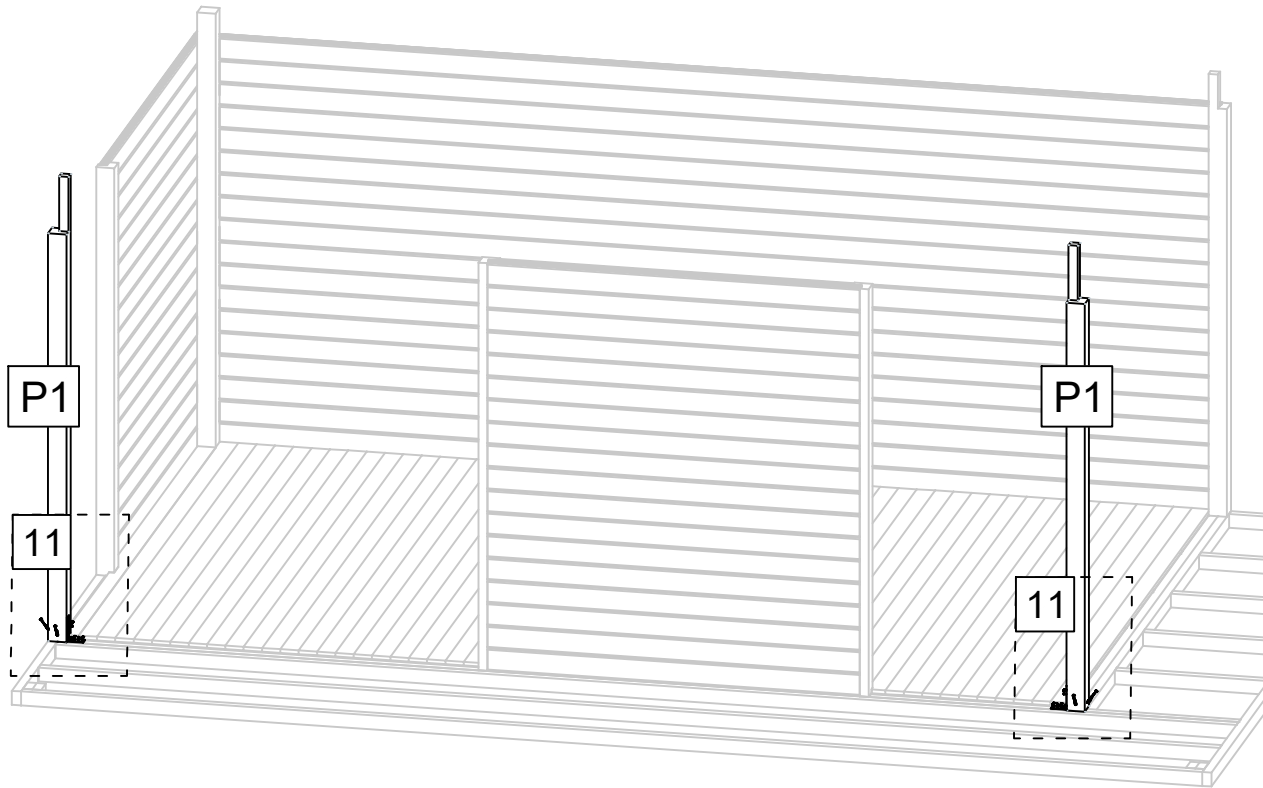

11.07.2023

11

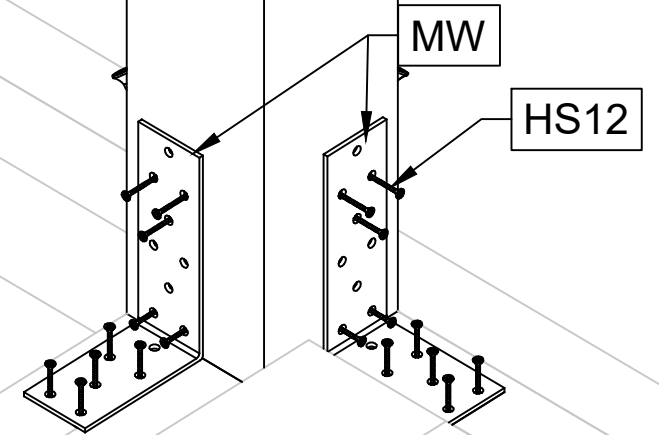

11

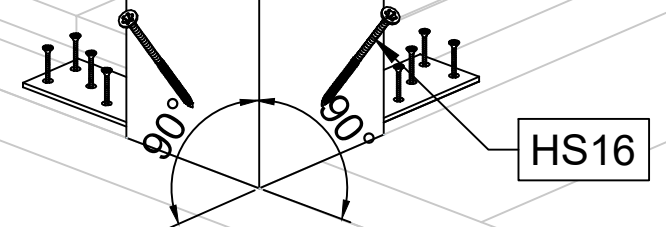

16/34

Art. Nr. 4425819

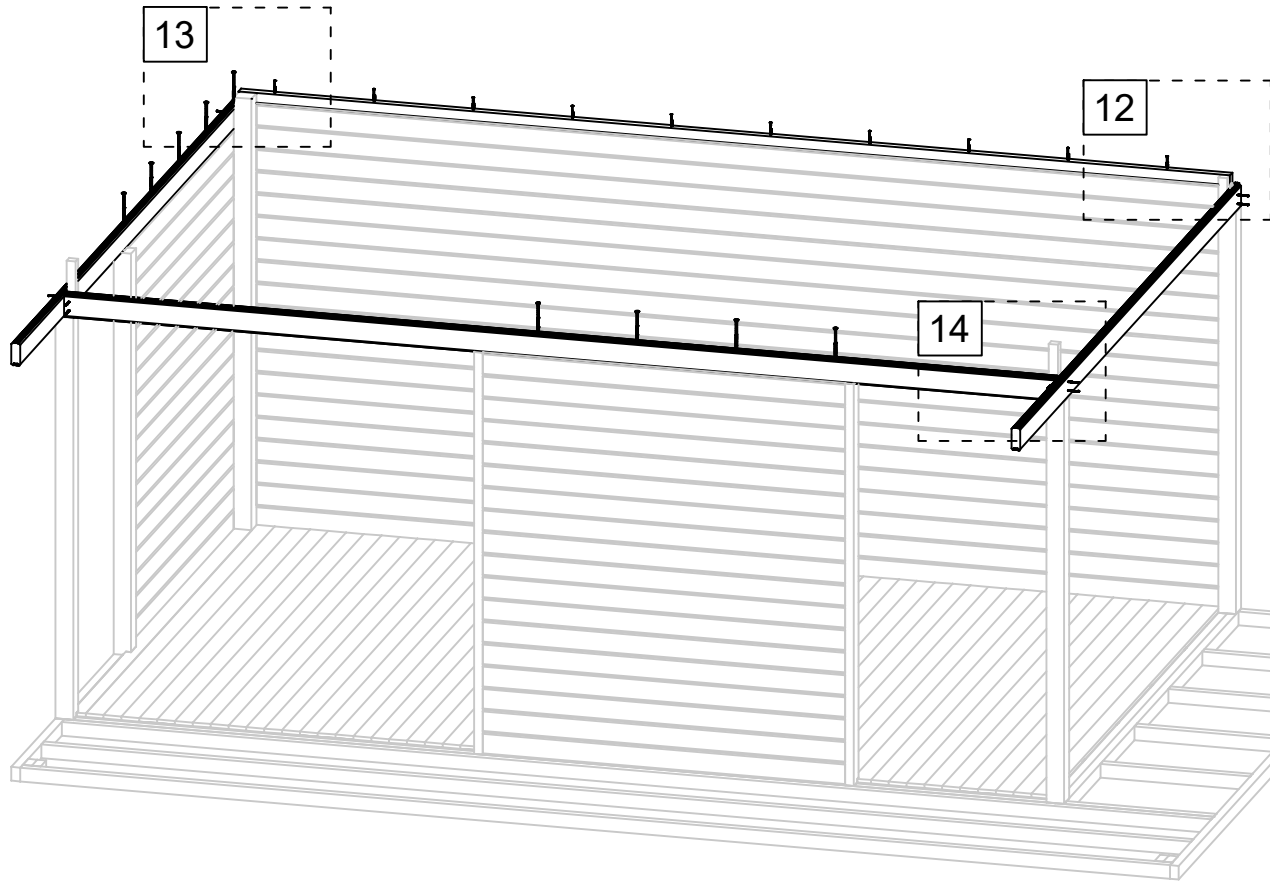

12

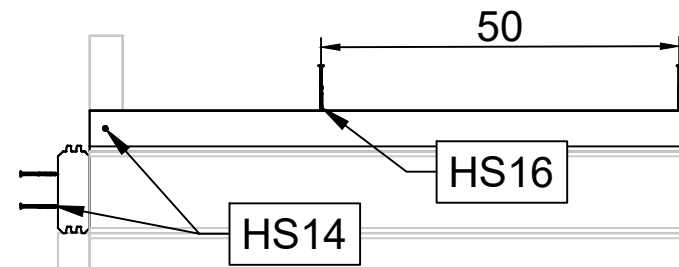

13

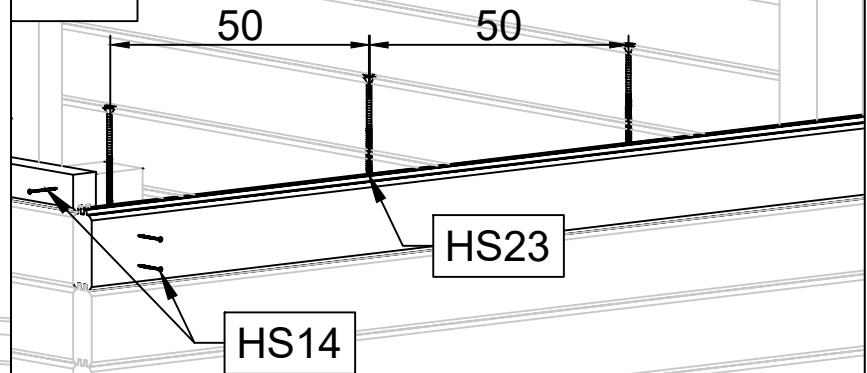

14

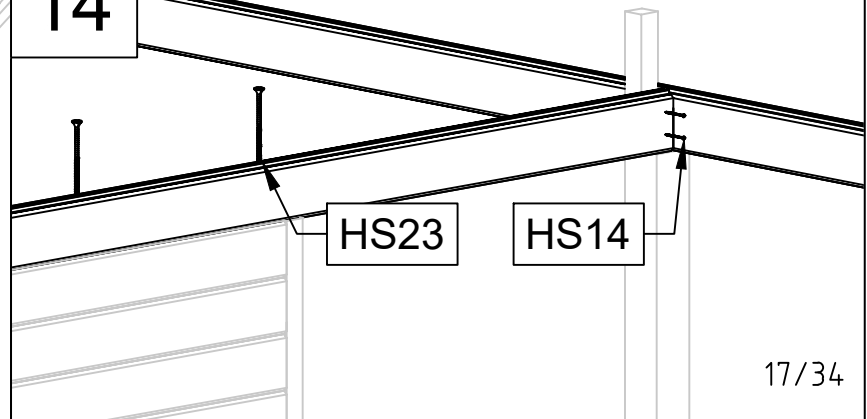

Art. Nr. 4425819

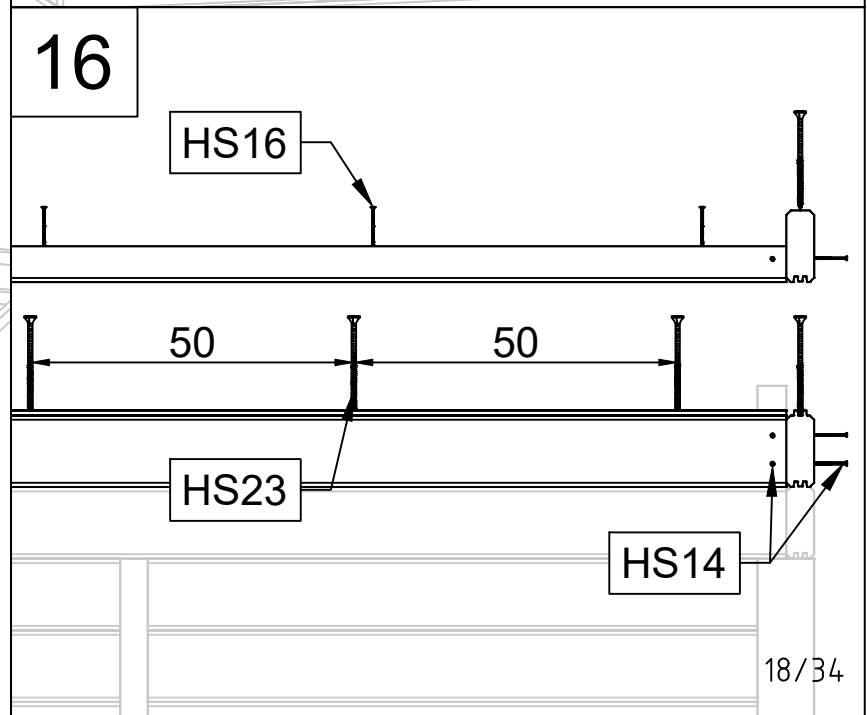
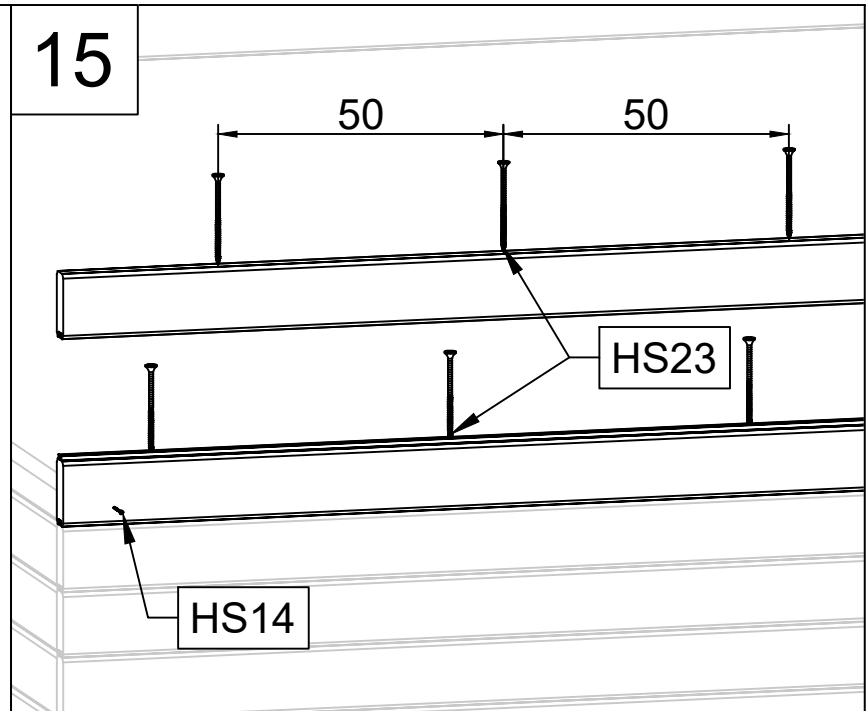
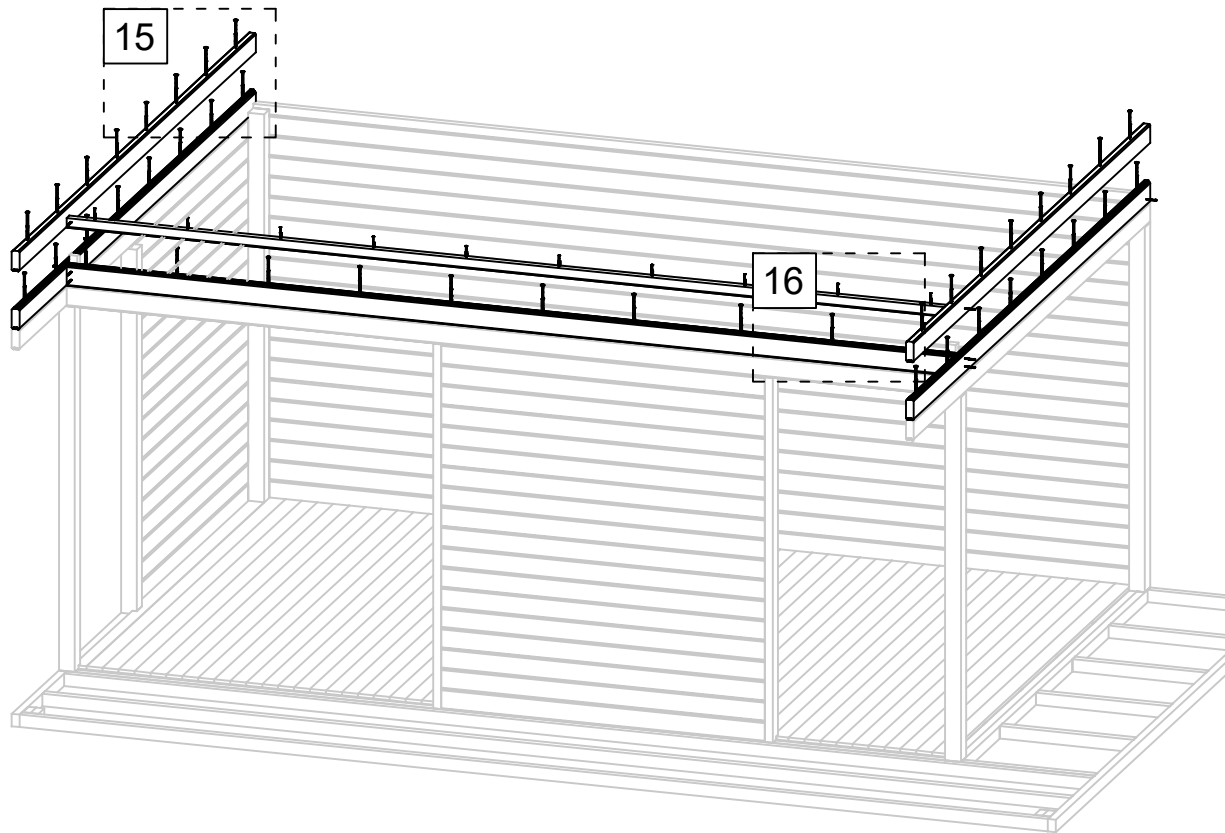

Art. Nr. 4425819

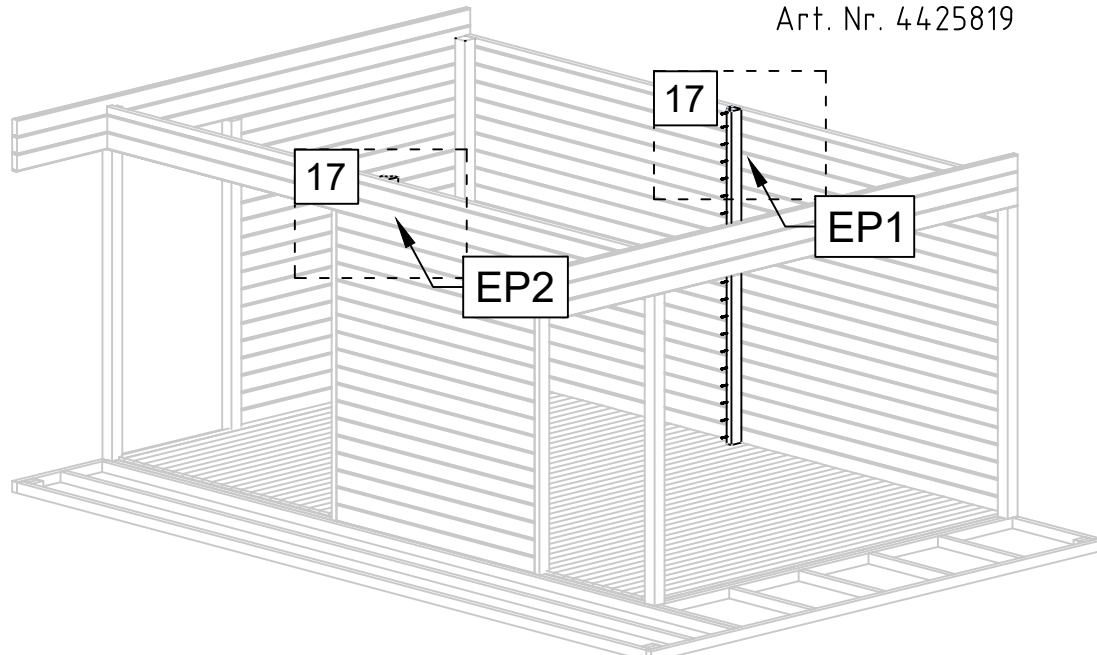

17

Min 223.4 cm-
Max 383.4 cm

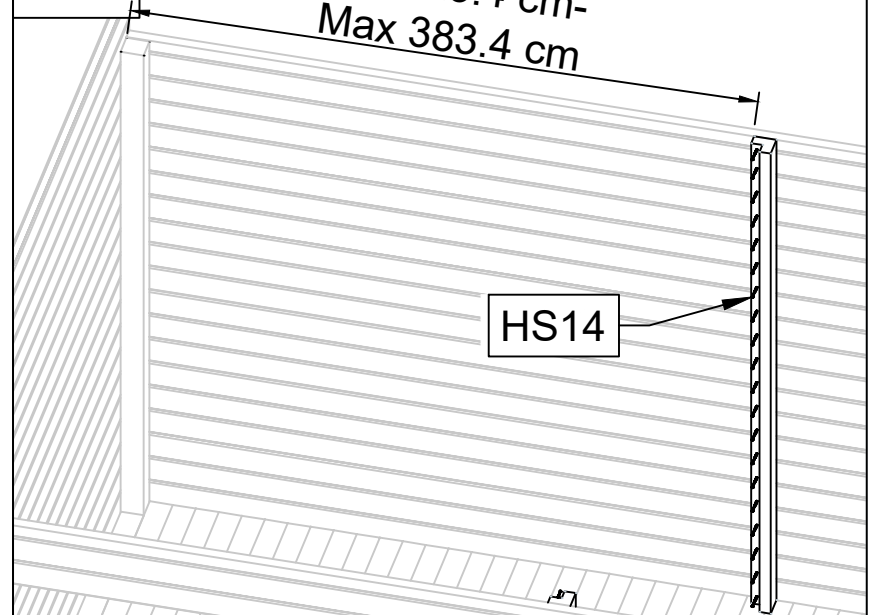

HS14

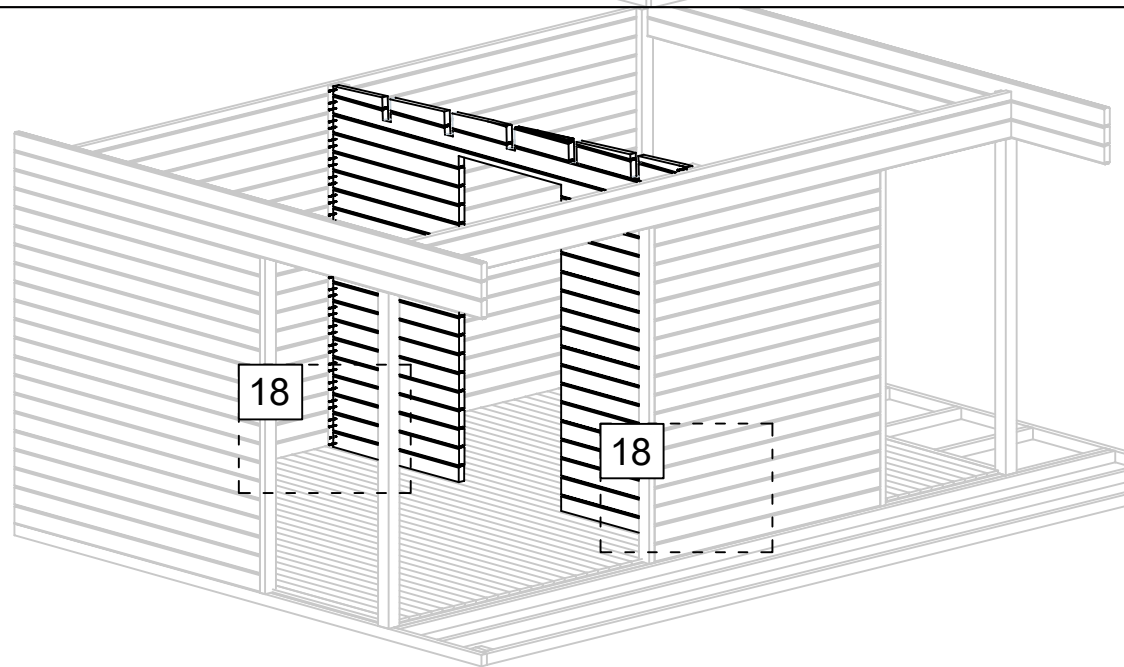

18

EP

18

18

HS14

Art. Nr. 4425819

DL1

19

DL2

19

20

19

DL

HS8

20

HS12

HS12

FF9

FF9

Art. Nr. 4425819

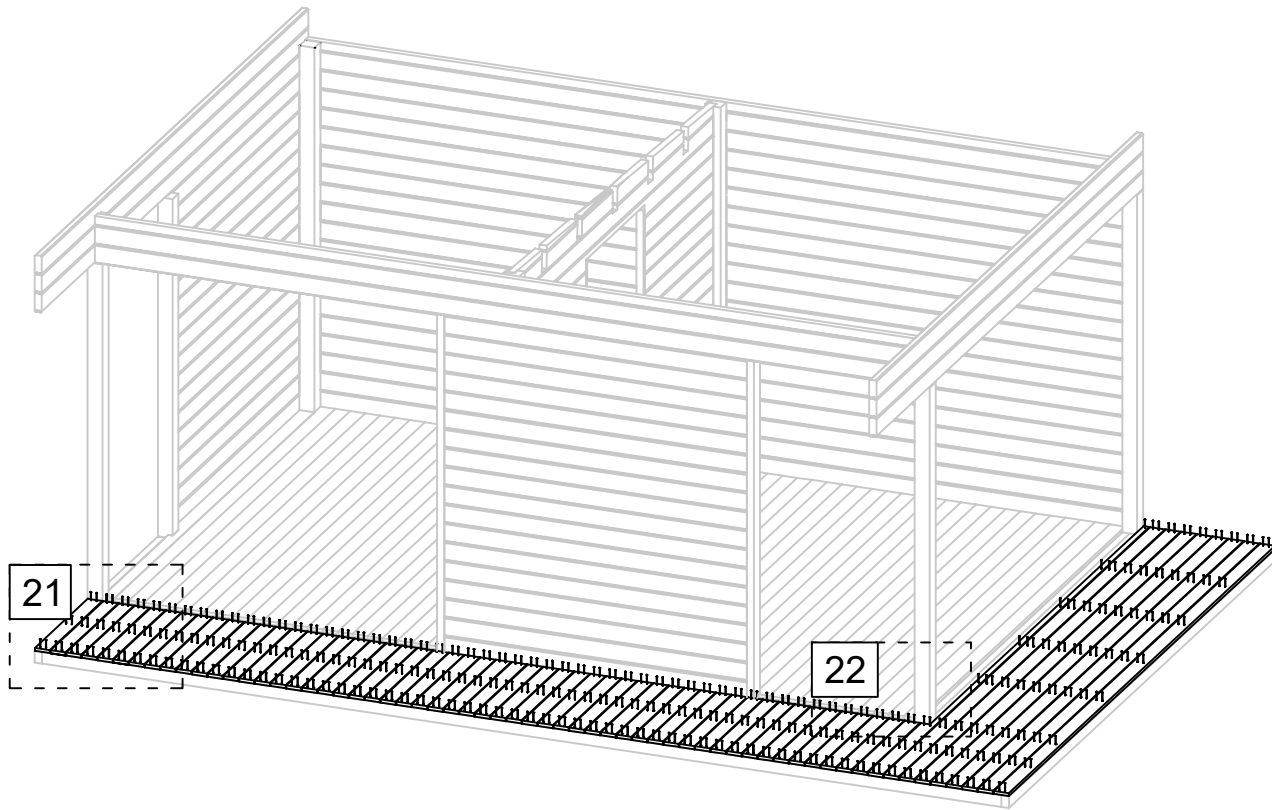

21

22

11.07.2023

21

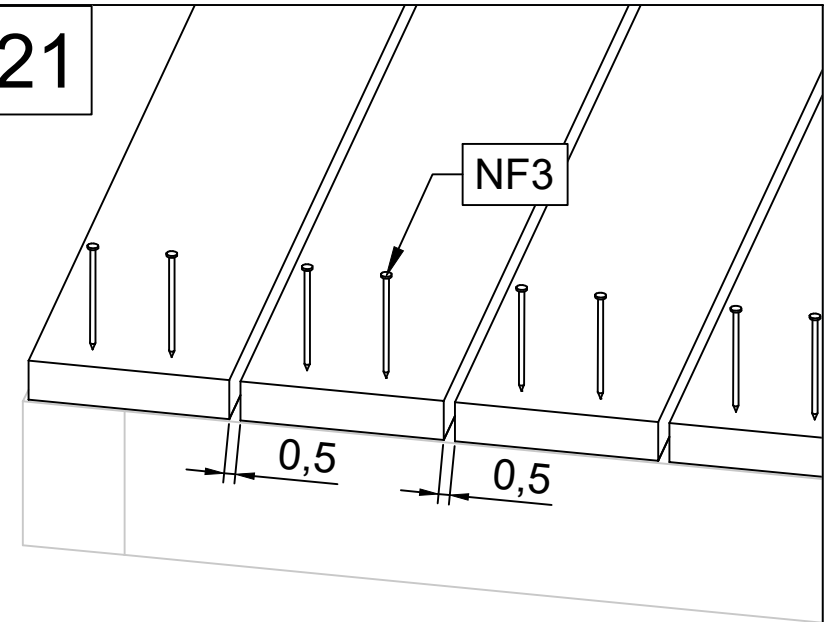

NF3

0,5

0,5

22

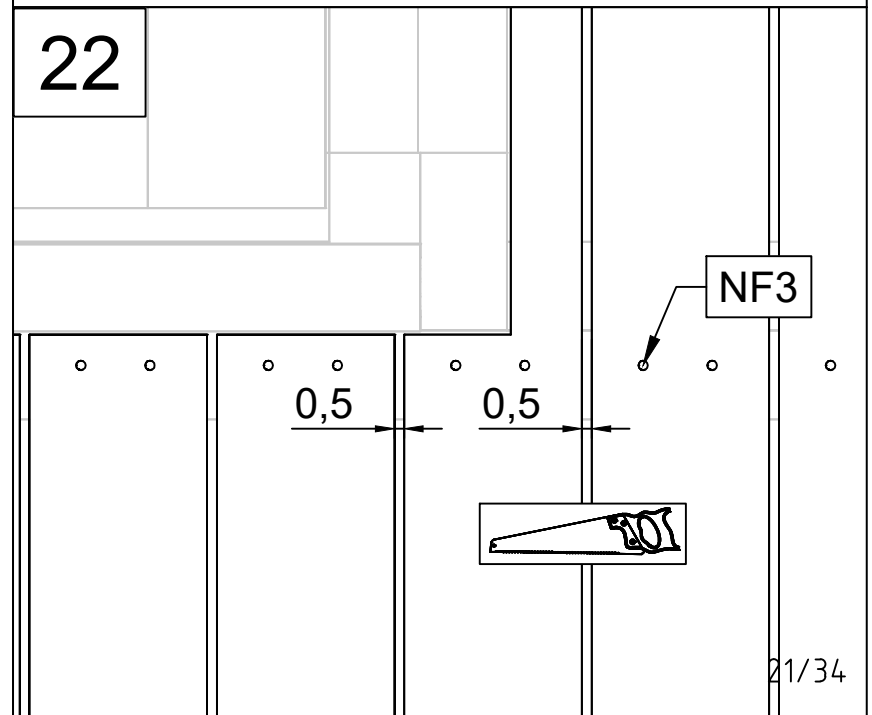

NF3

0,5

0,5

21/34

Art. Nr. 4425819

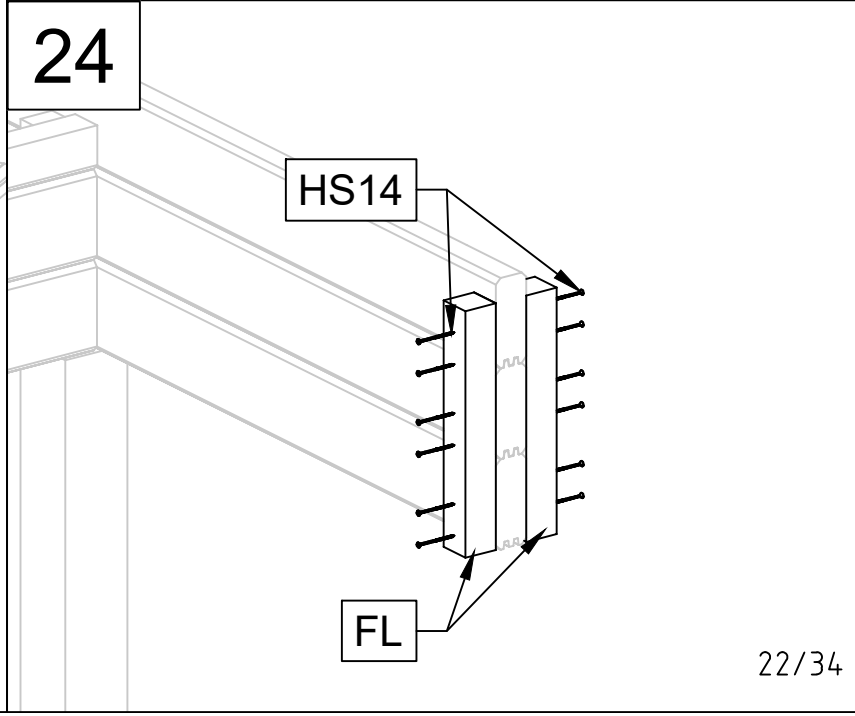
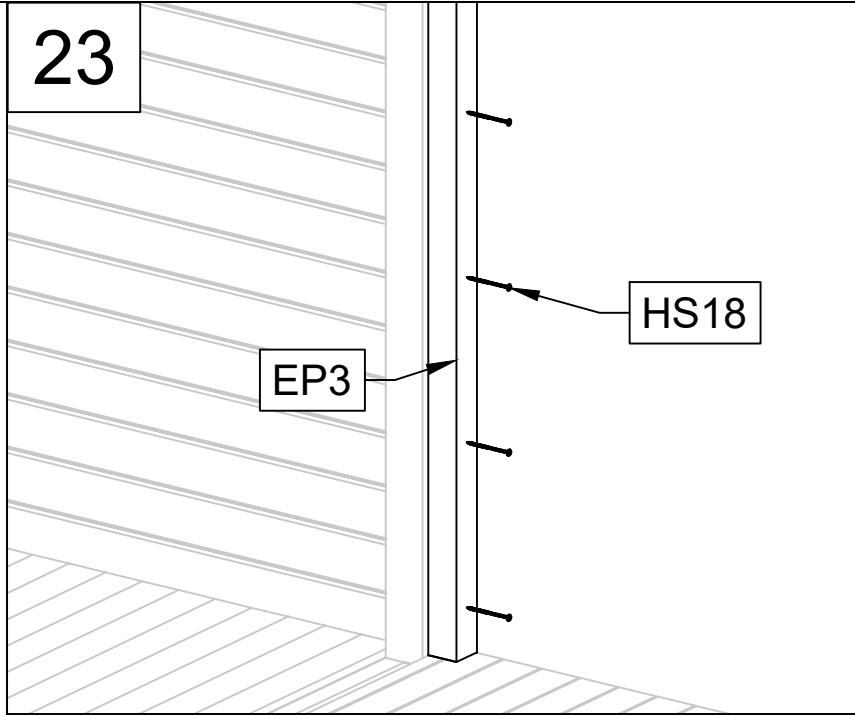
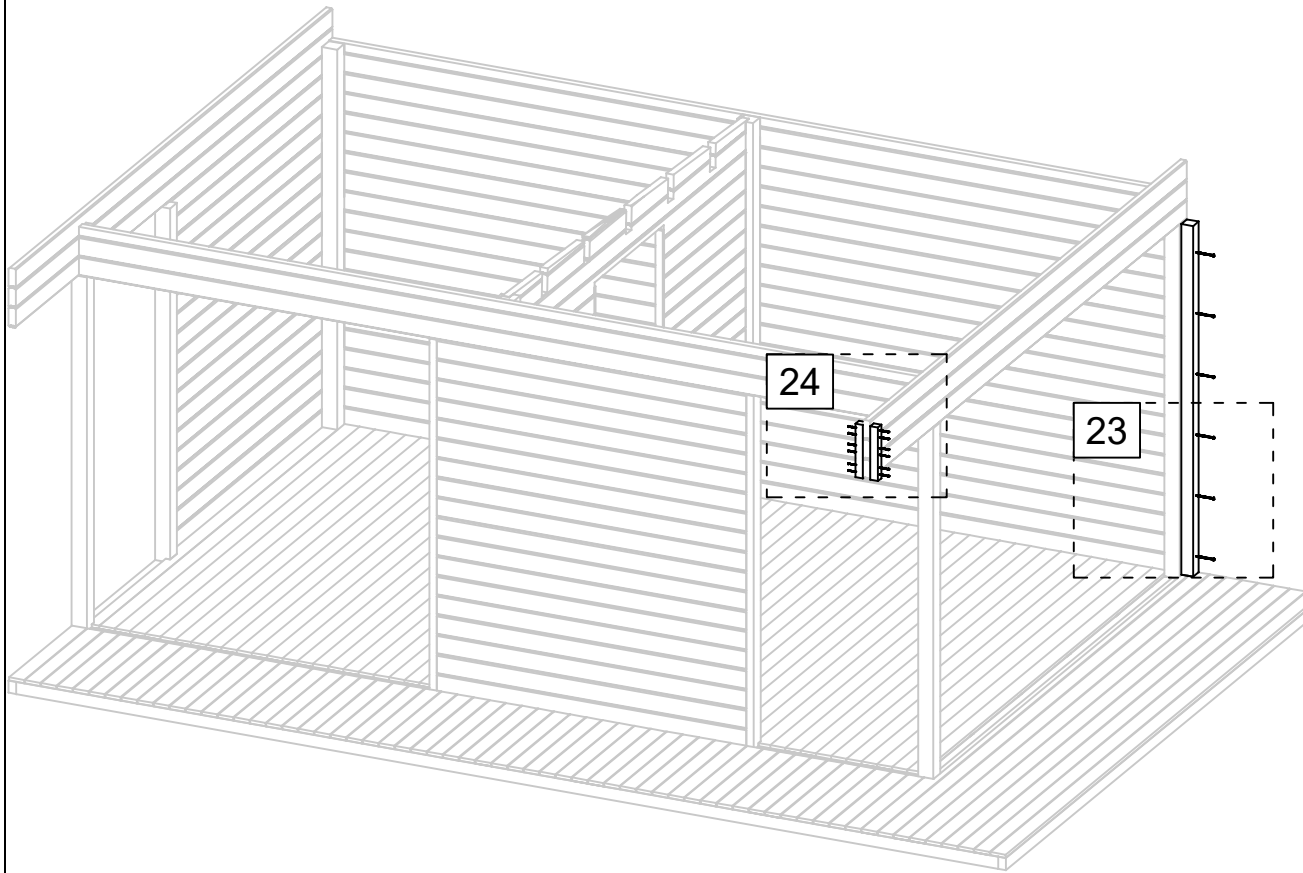

Art. Nr. 4425819

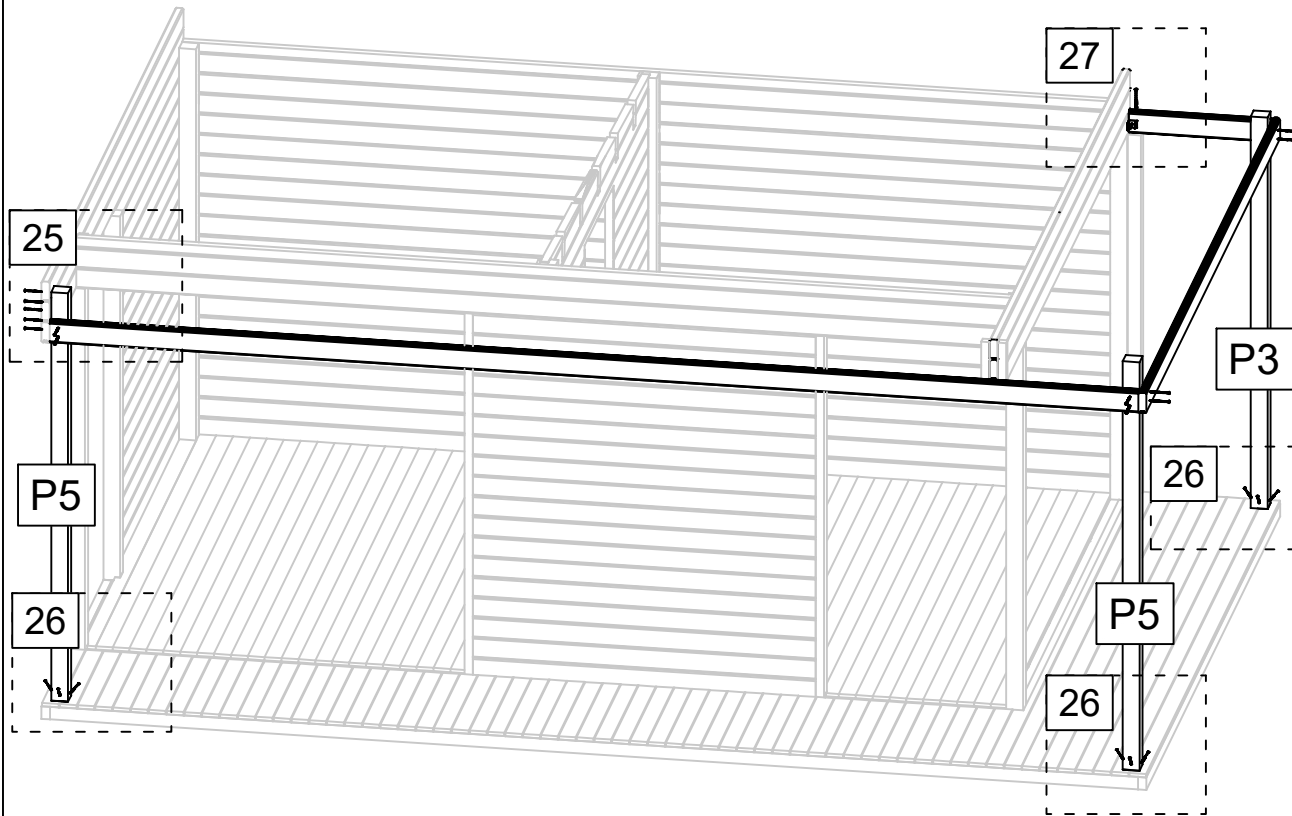

25

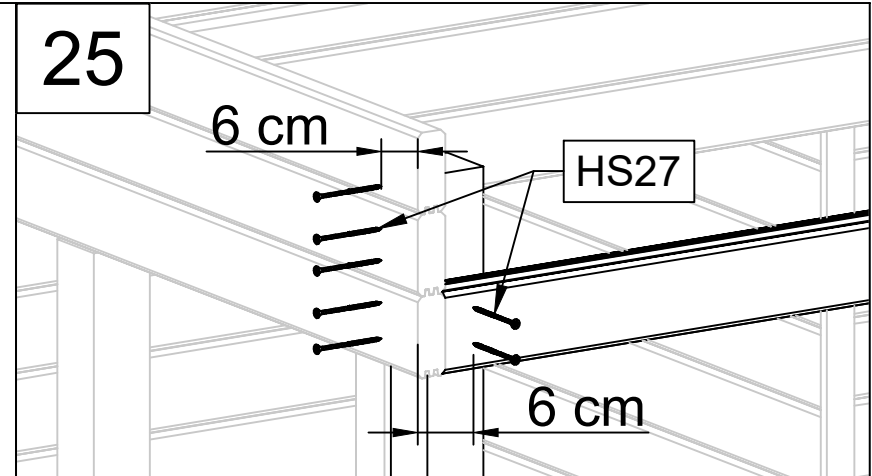

26

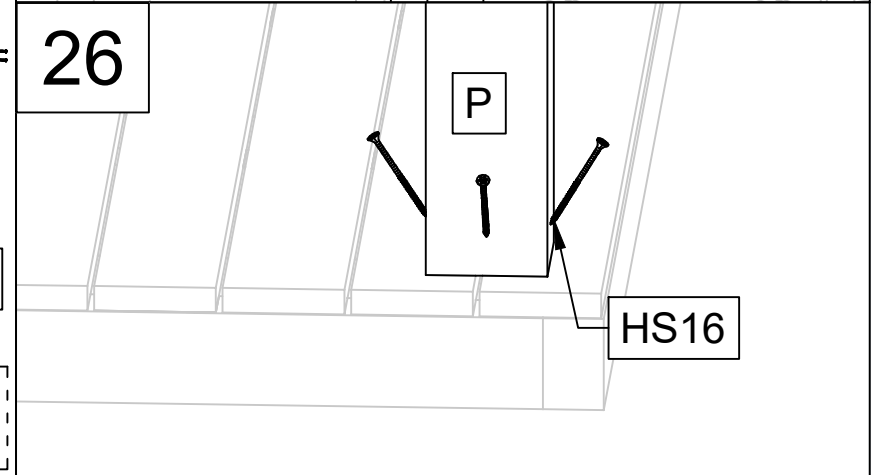

27

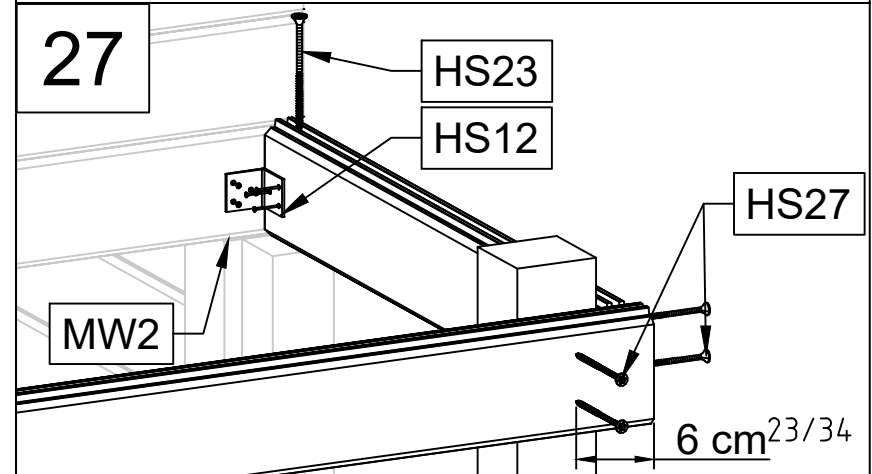

Art. Nr. 4425819

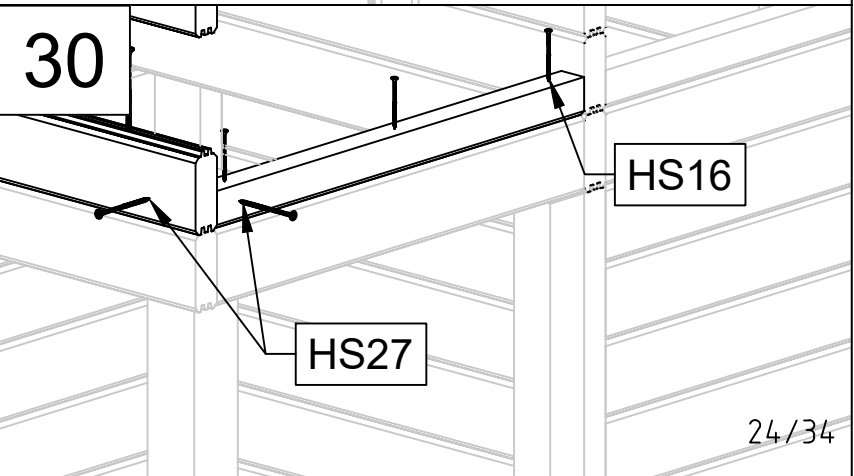
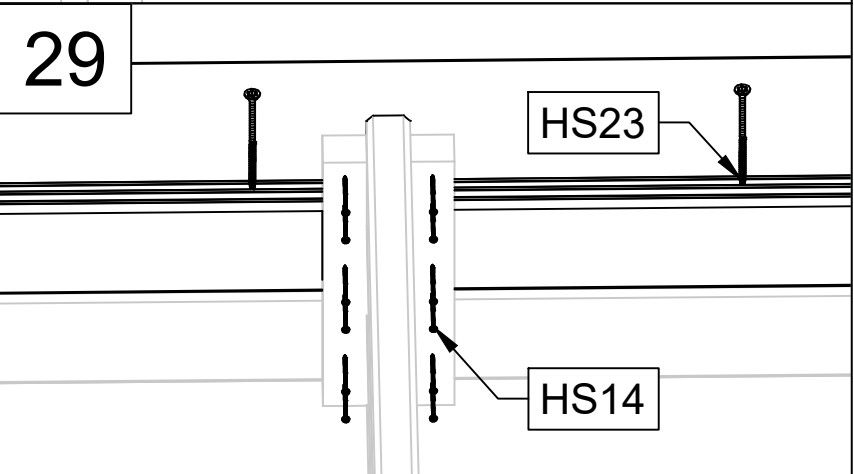
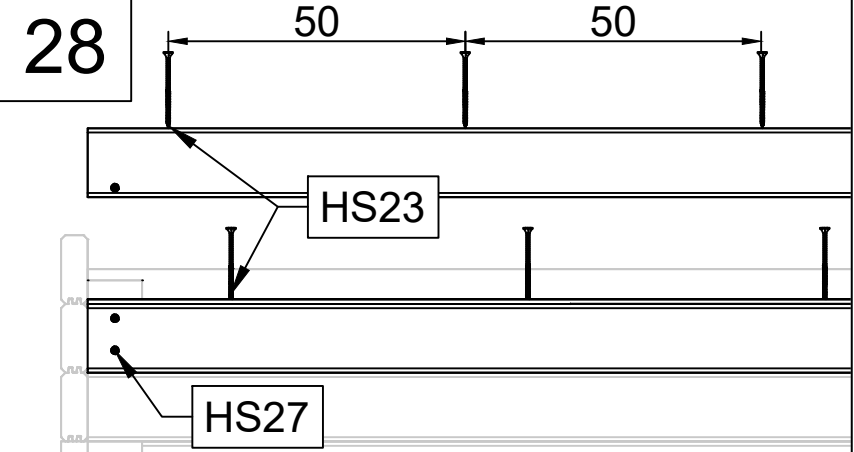
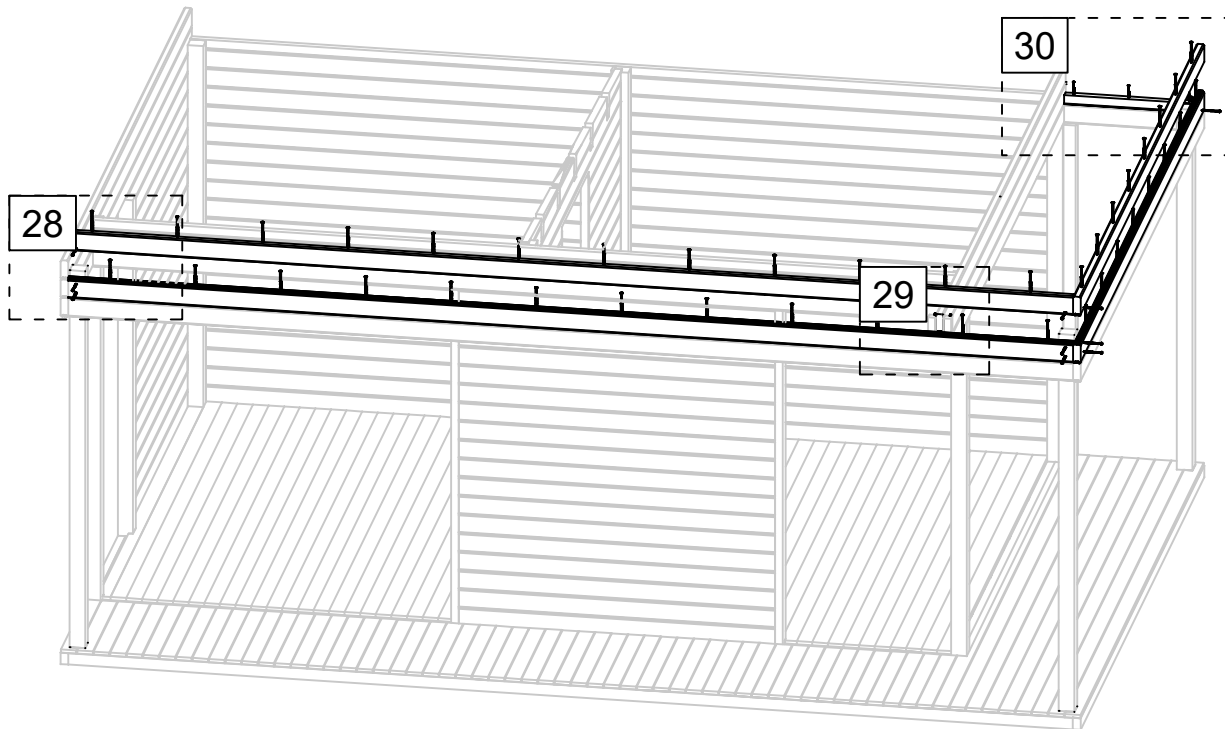

Art. Nr. 4425819

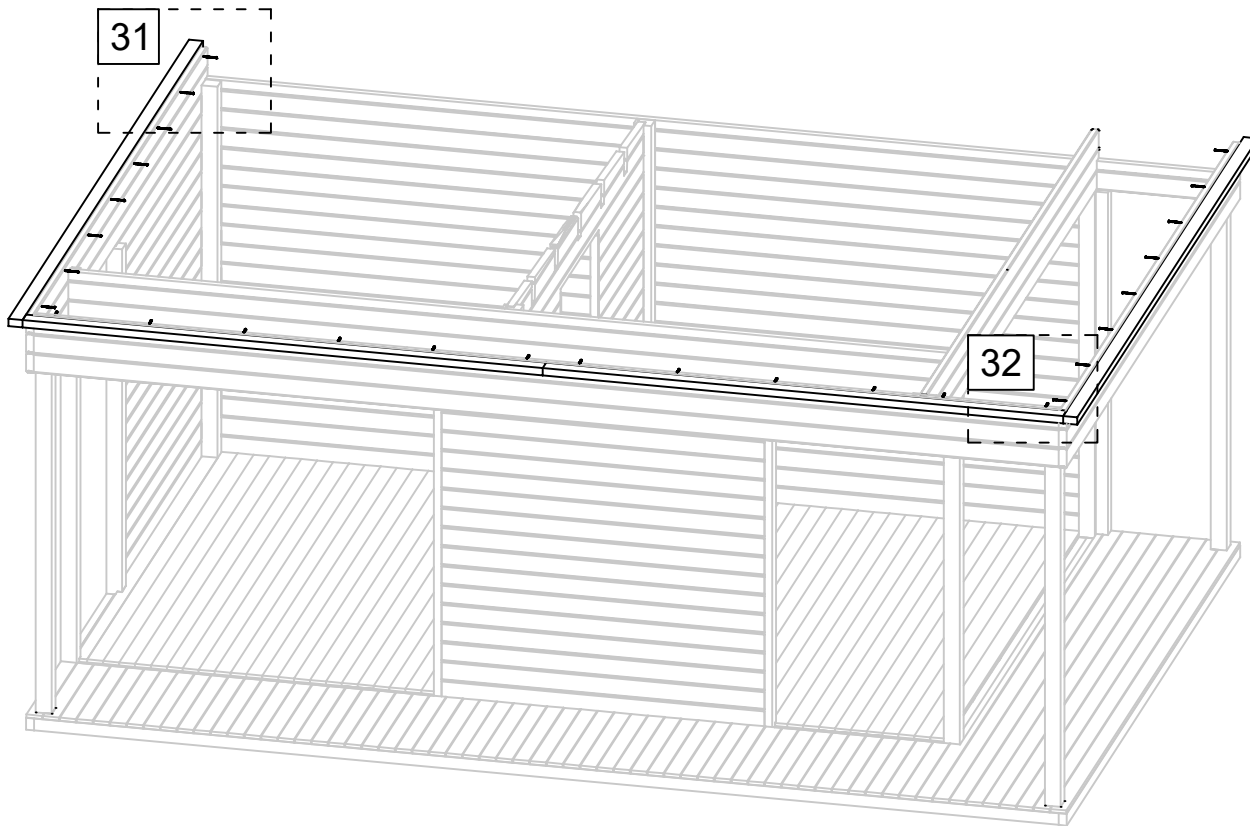

31

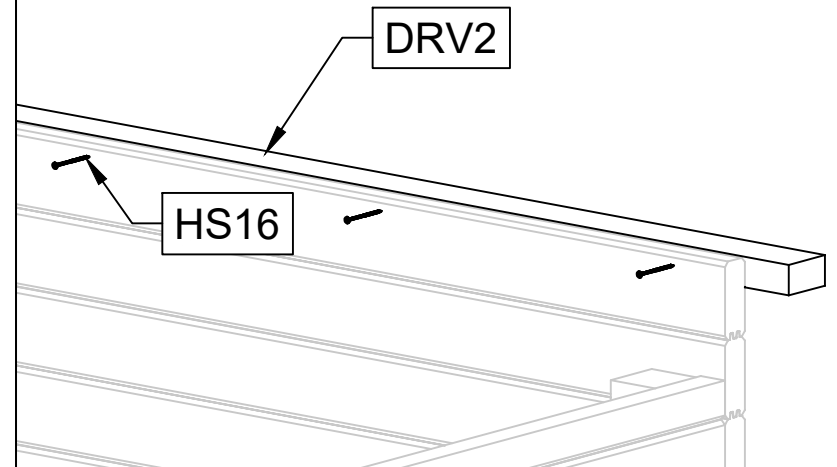

32

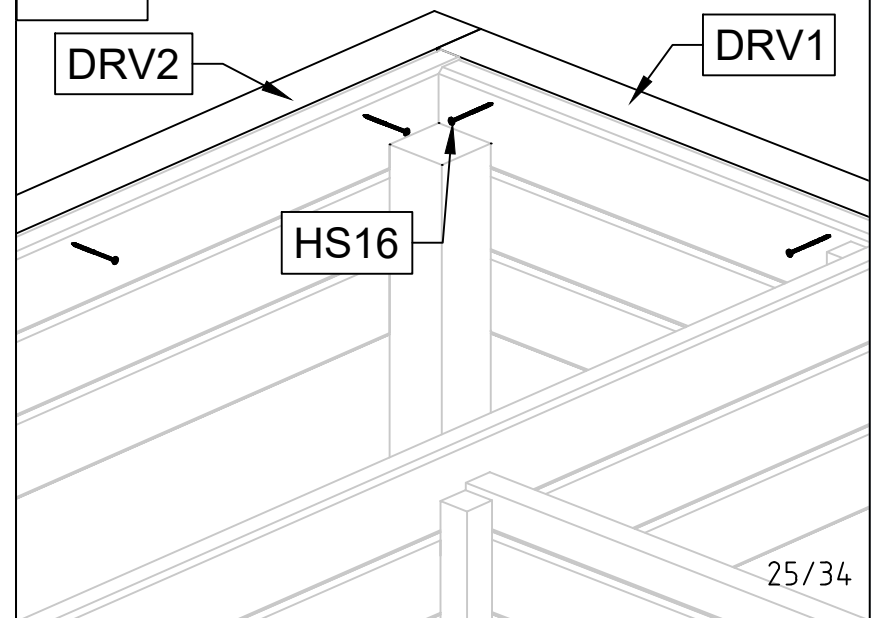

Art. Nr. 4425819

33

34

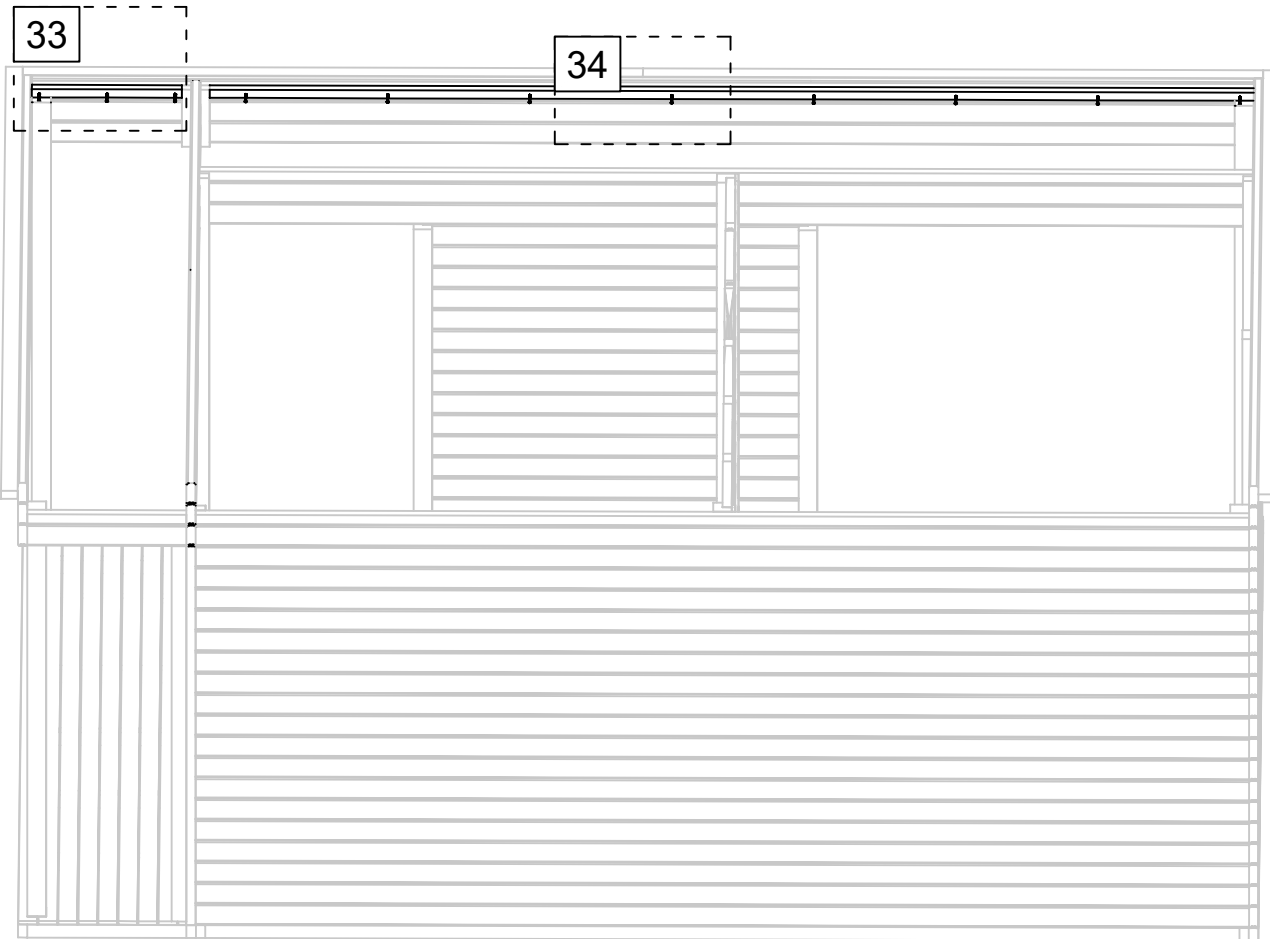

11.07.2023

33

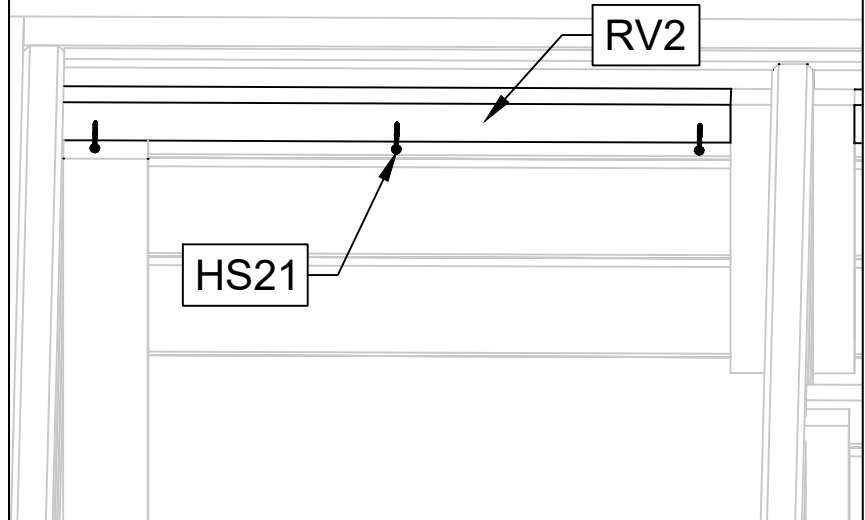

34

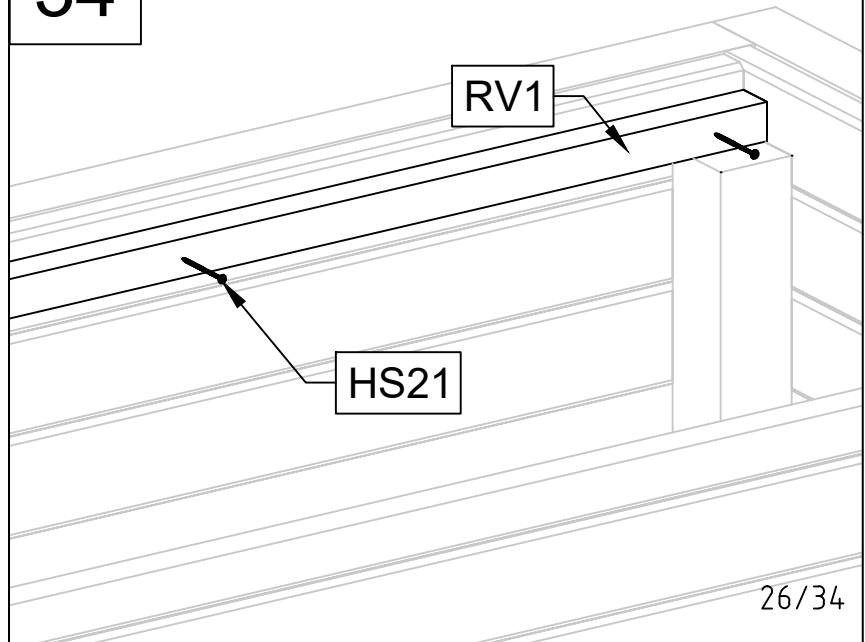

26/34

Art. Nr. 4425819

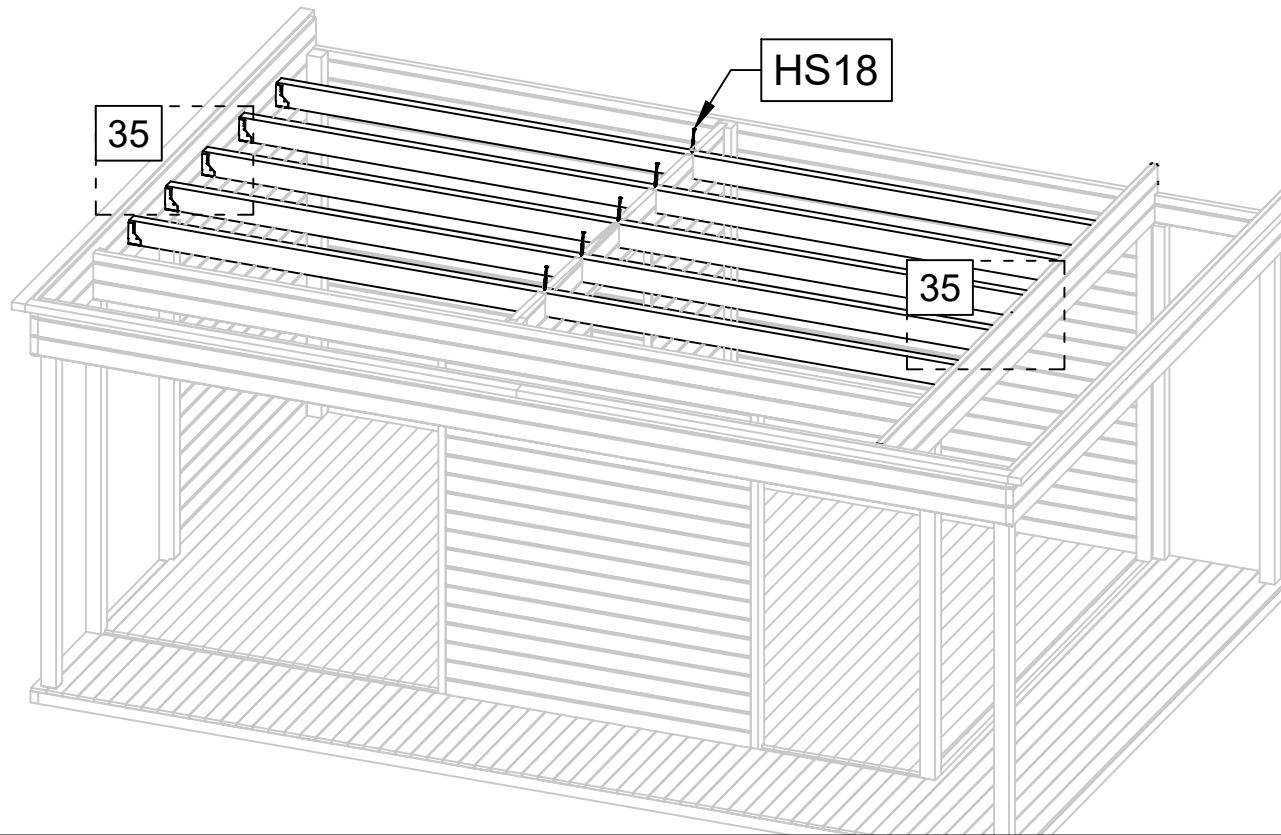

35

≈1,5cm

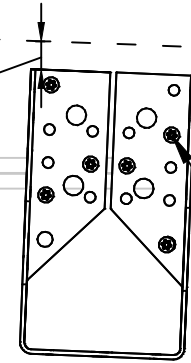

HS12

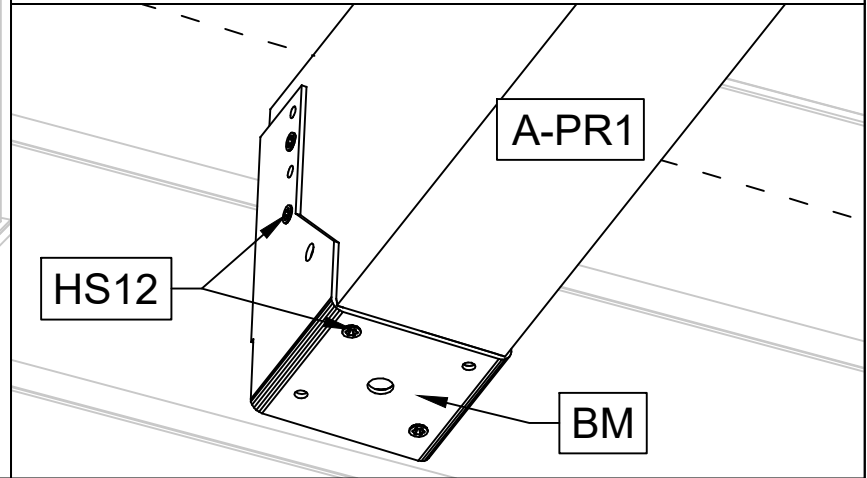

A-PR1

HS12

BM

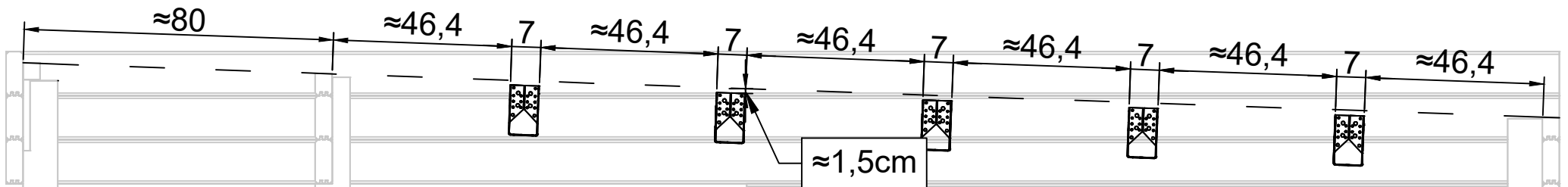

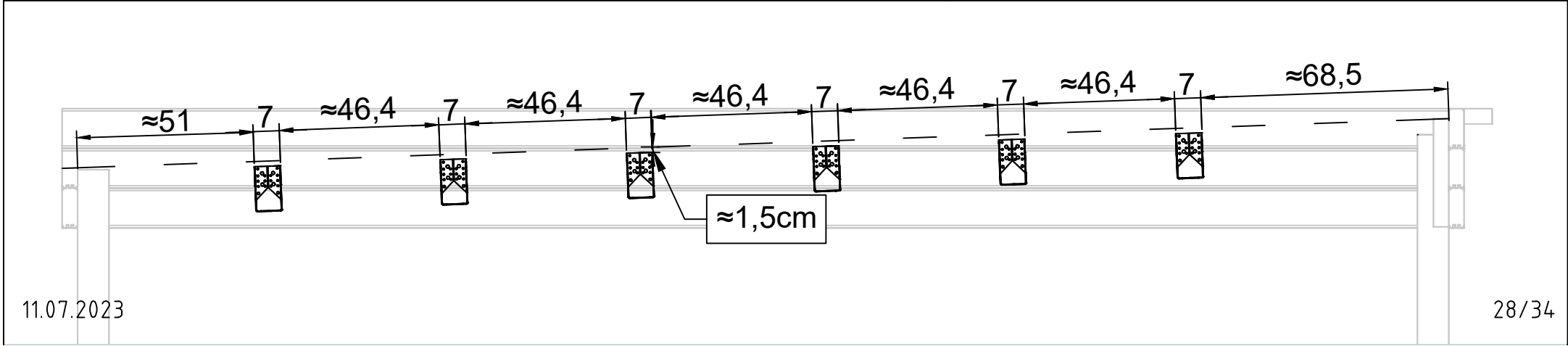
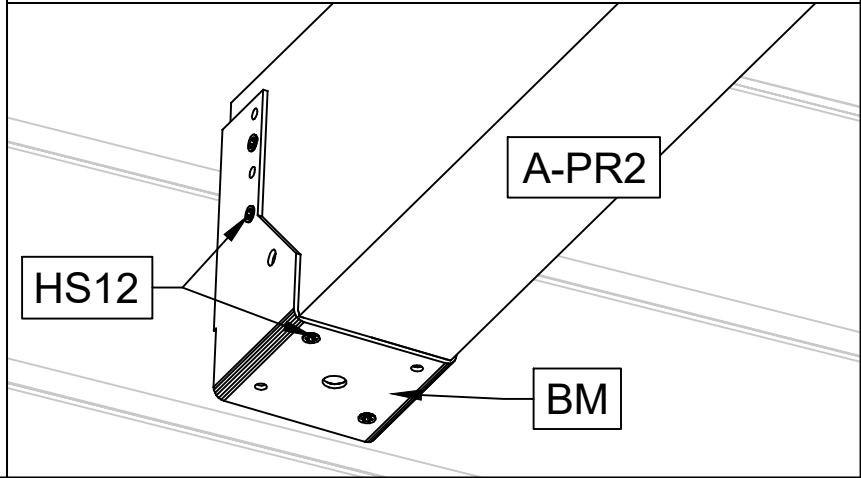
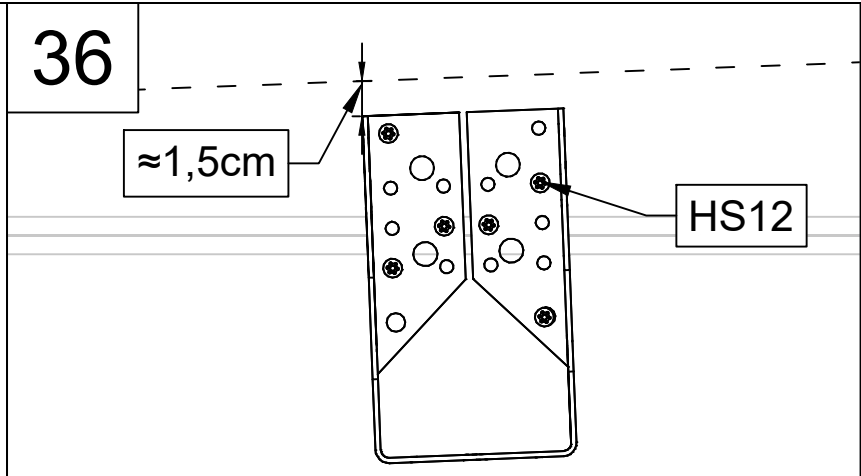
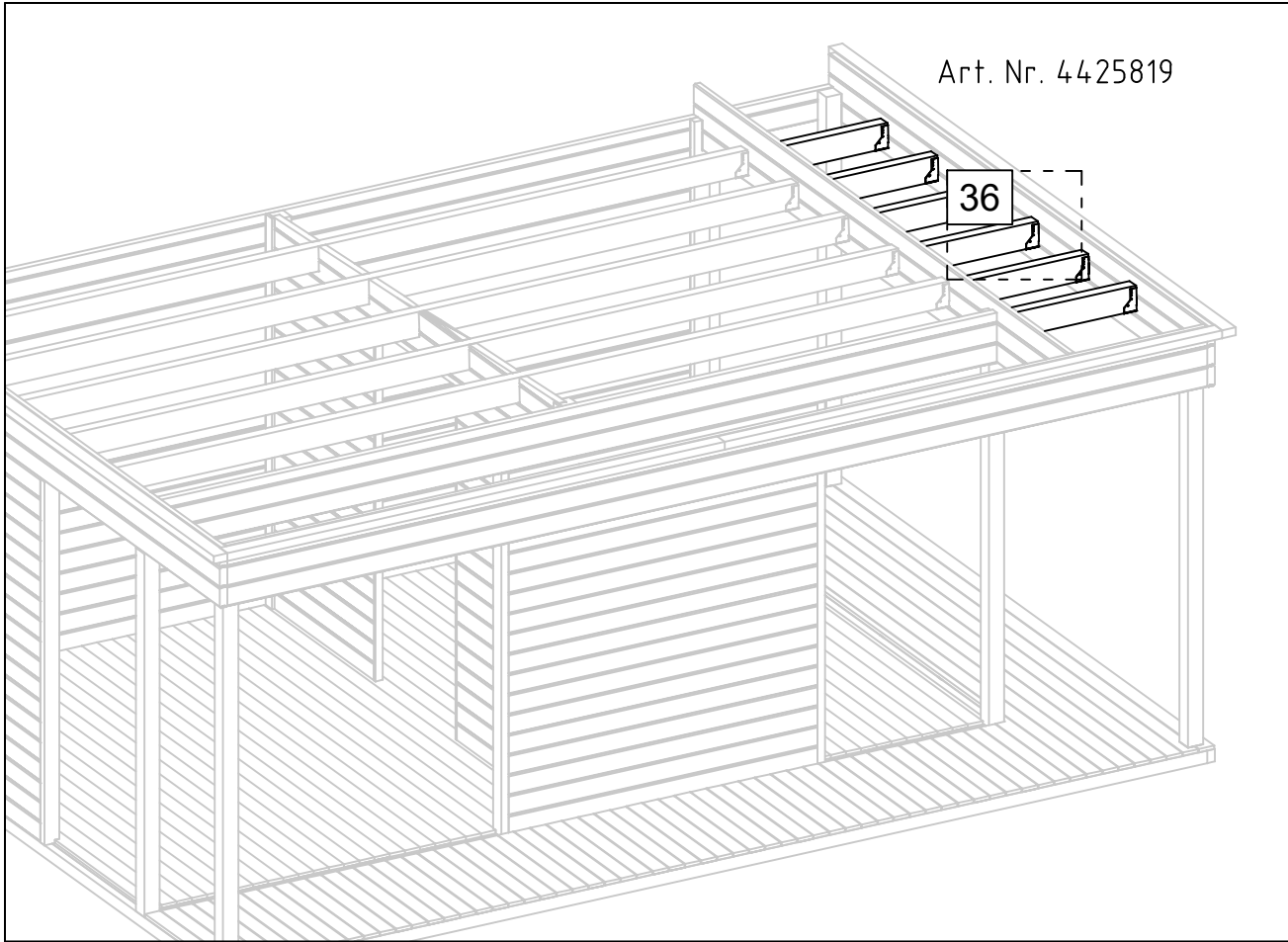

Art. Nr. 4425819

37

38

37

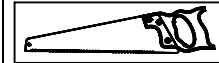
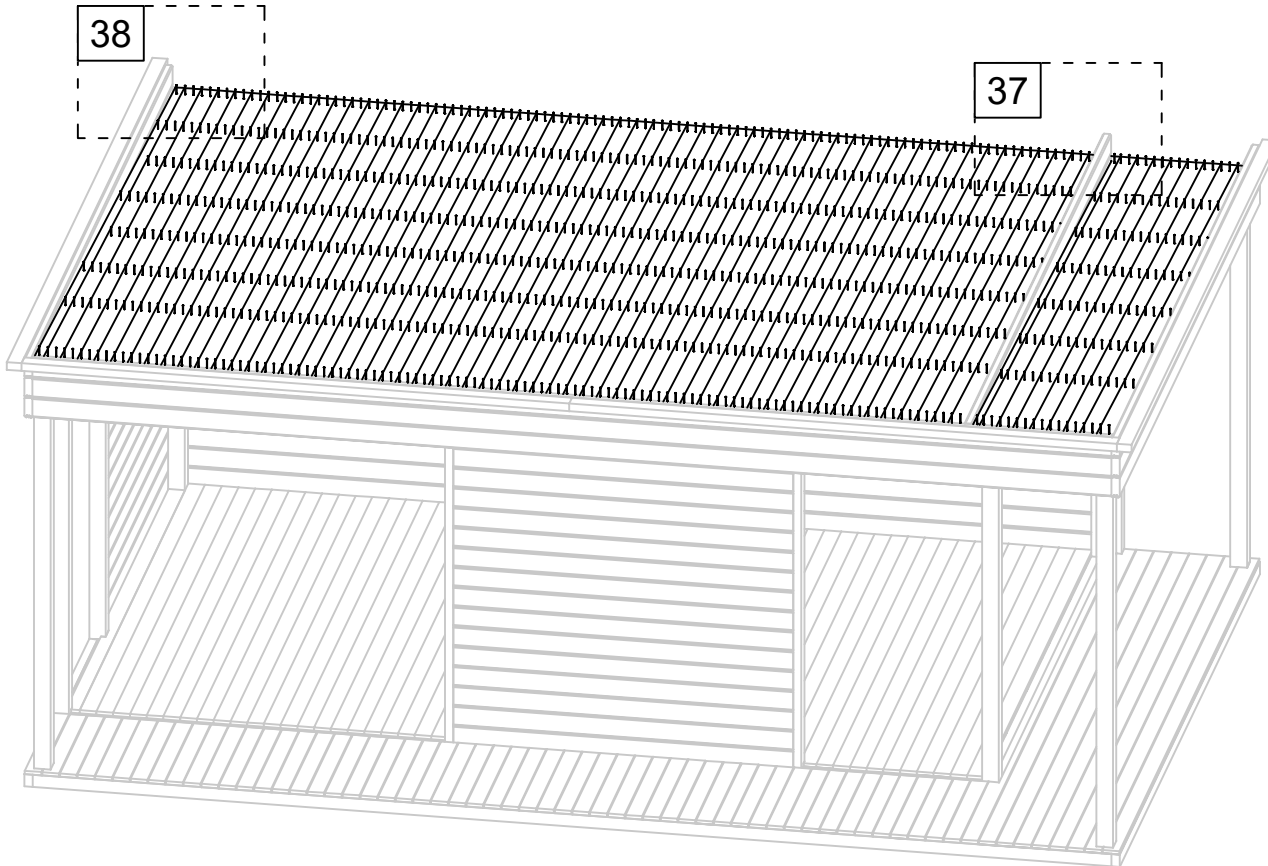

NF4

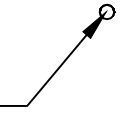

38

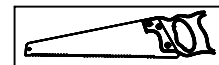

NF4



Art. Nr. 4425819

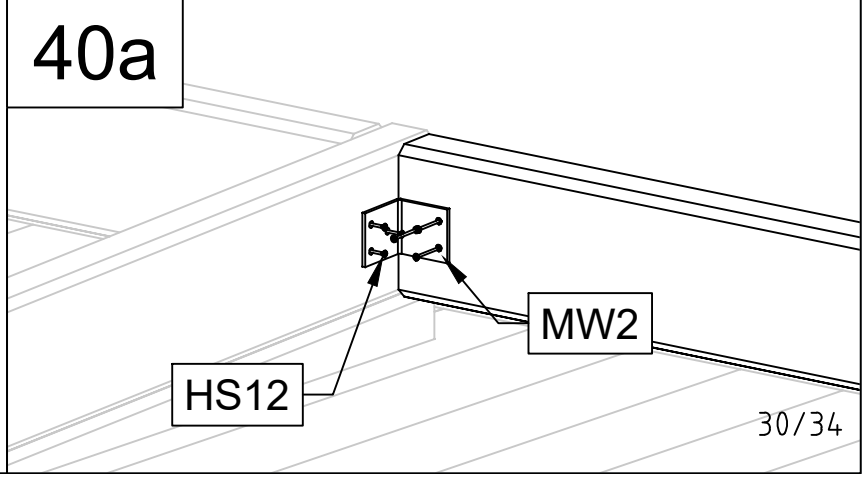
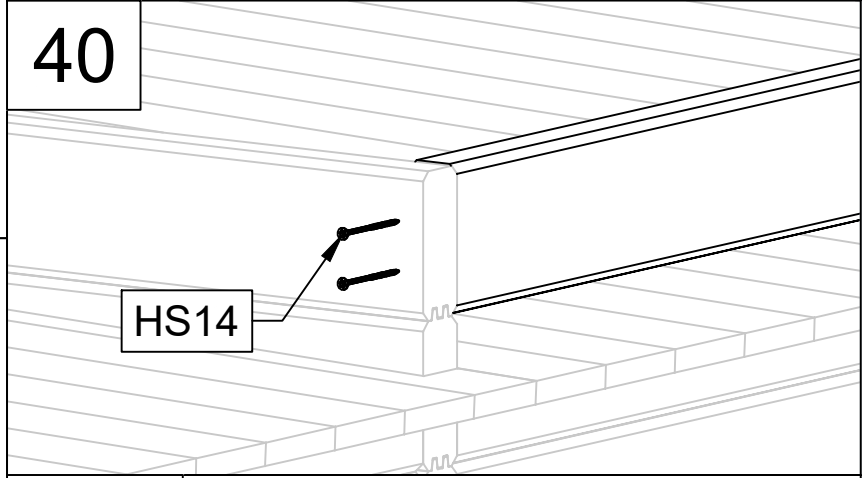
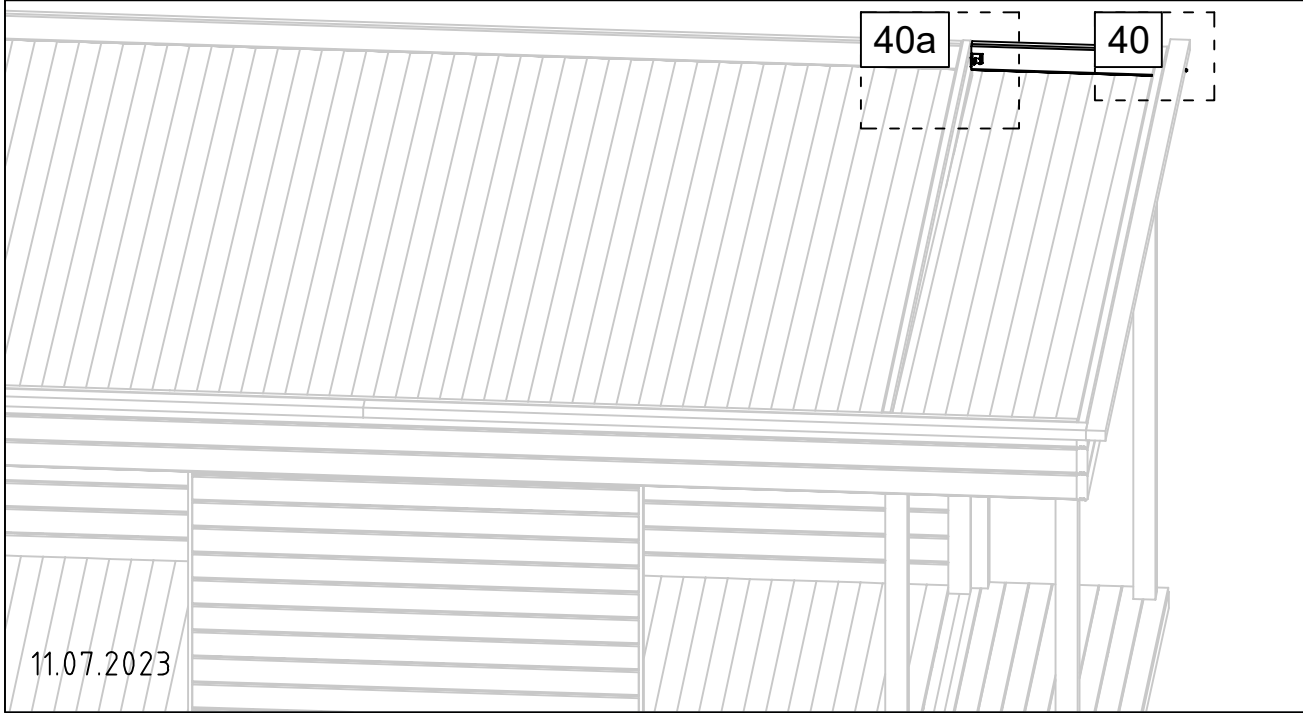
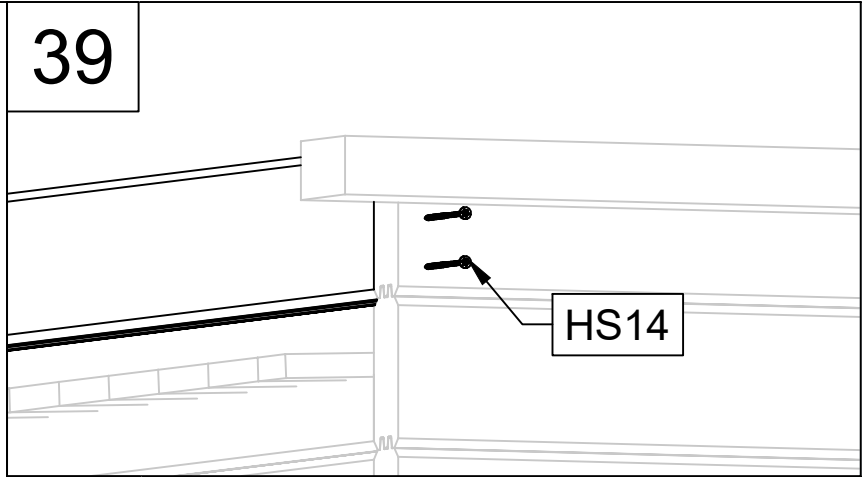
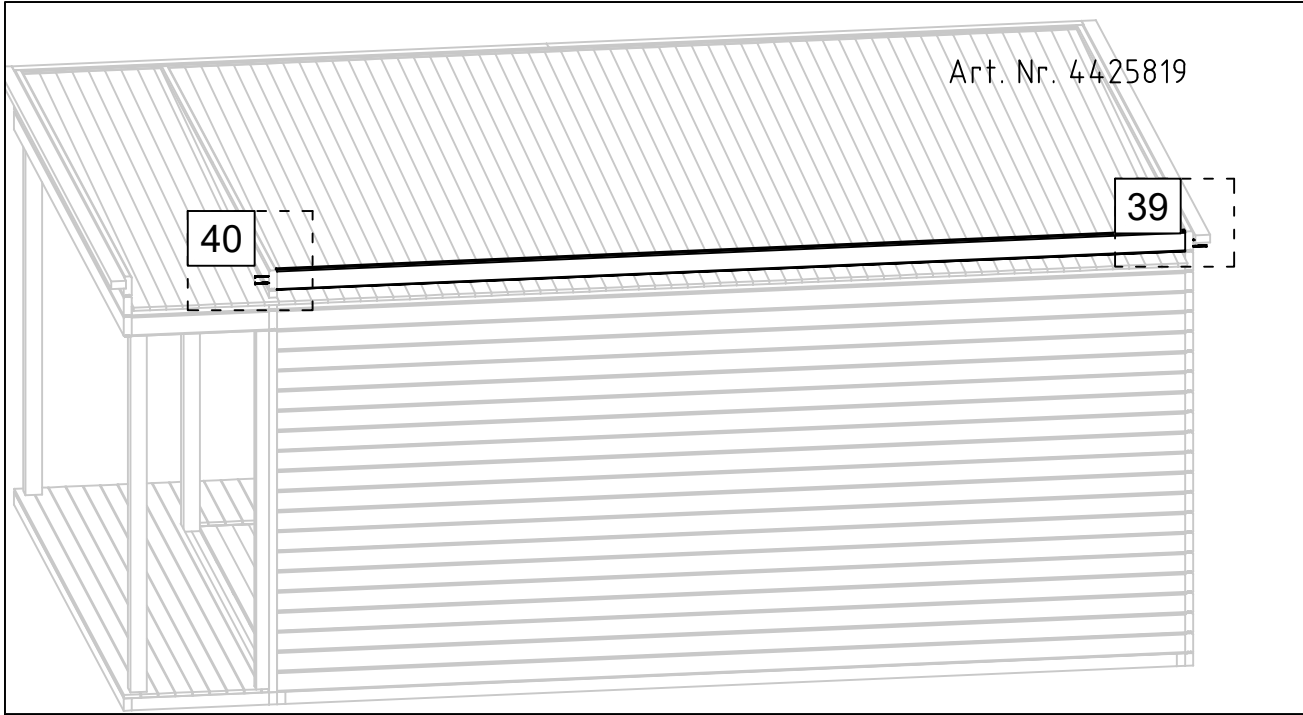

Art. Nr. 4425819

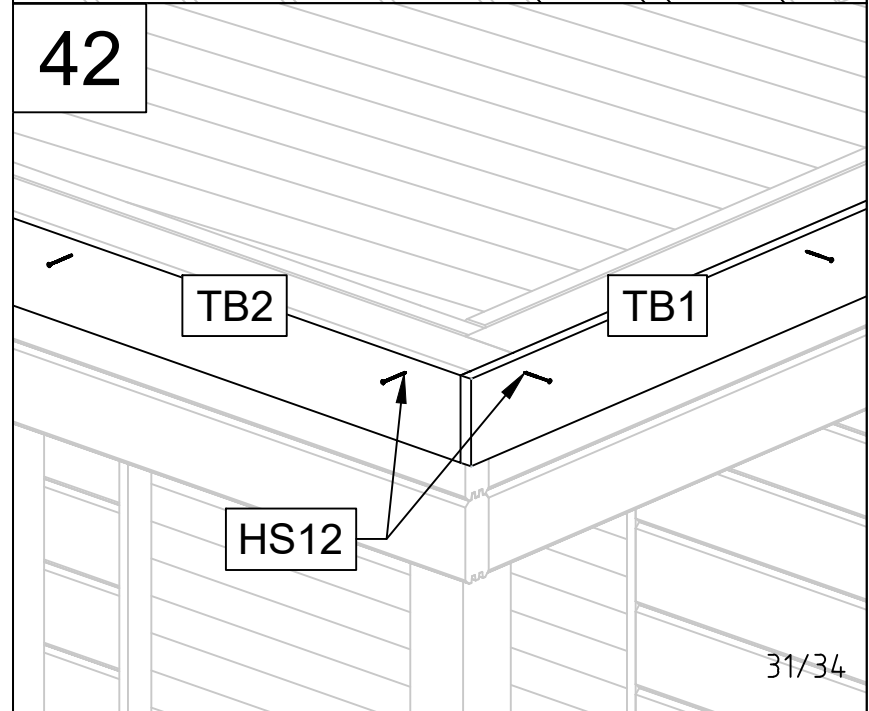
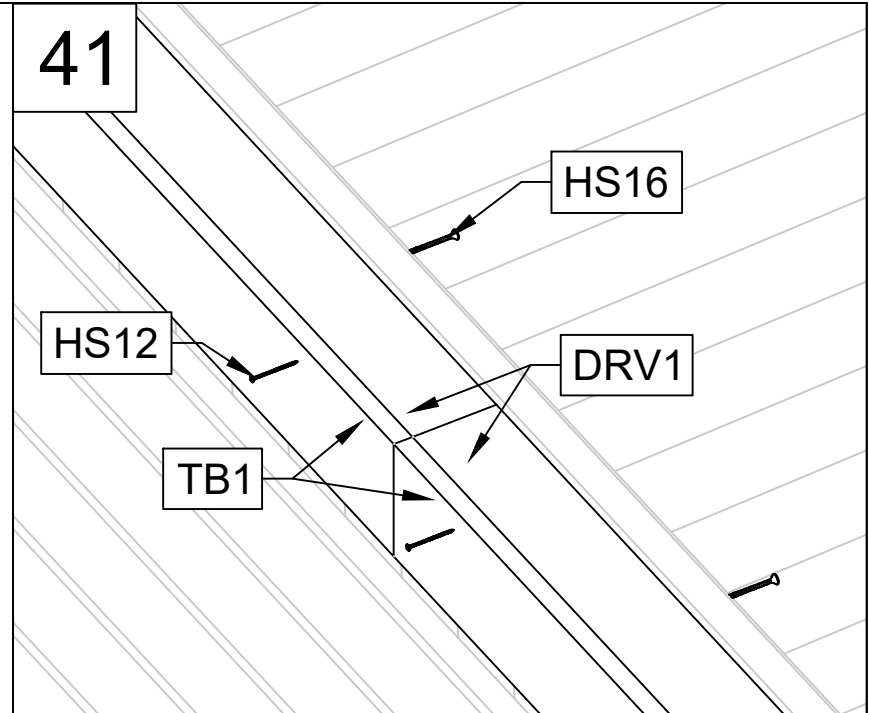
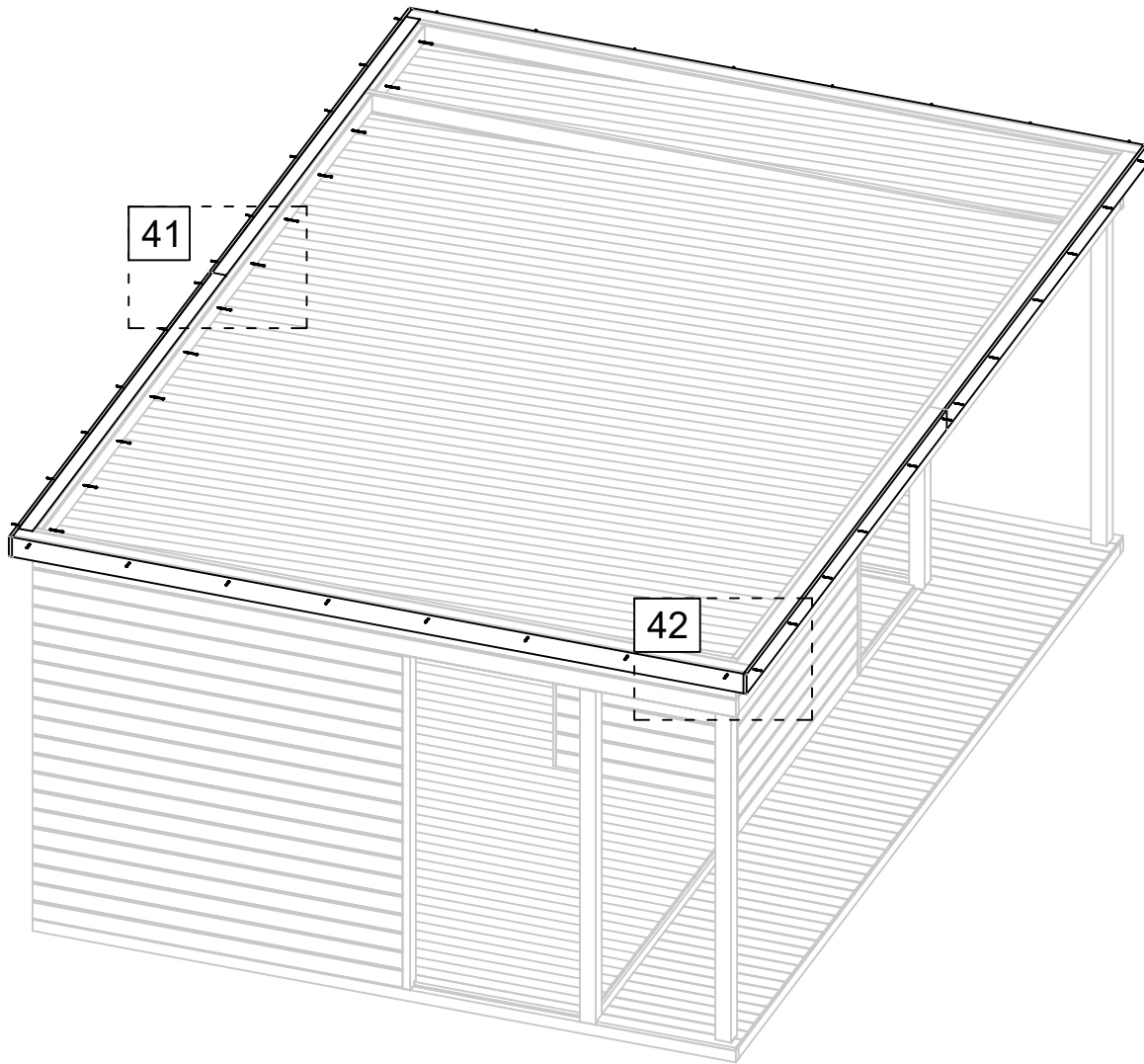

Art. Nr. 4425819

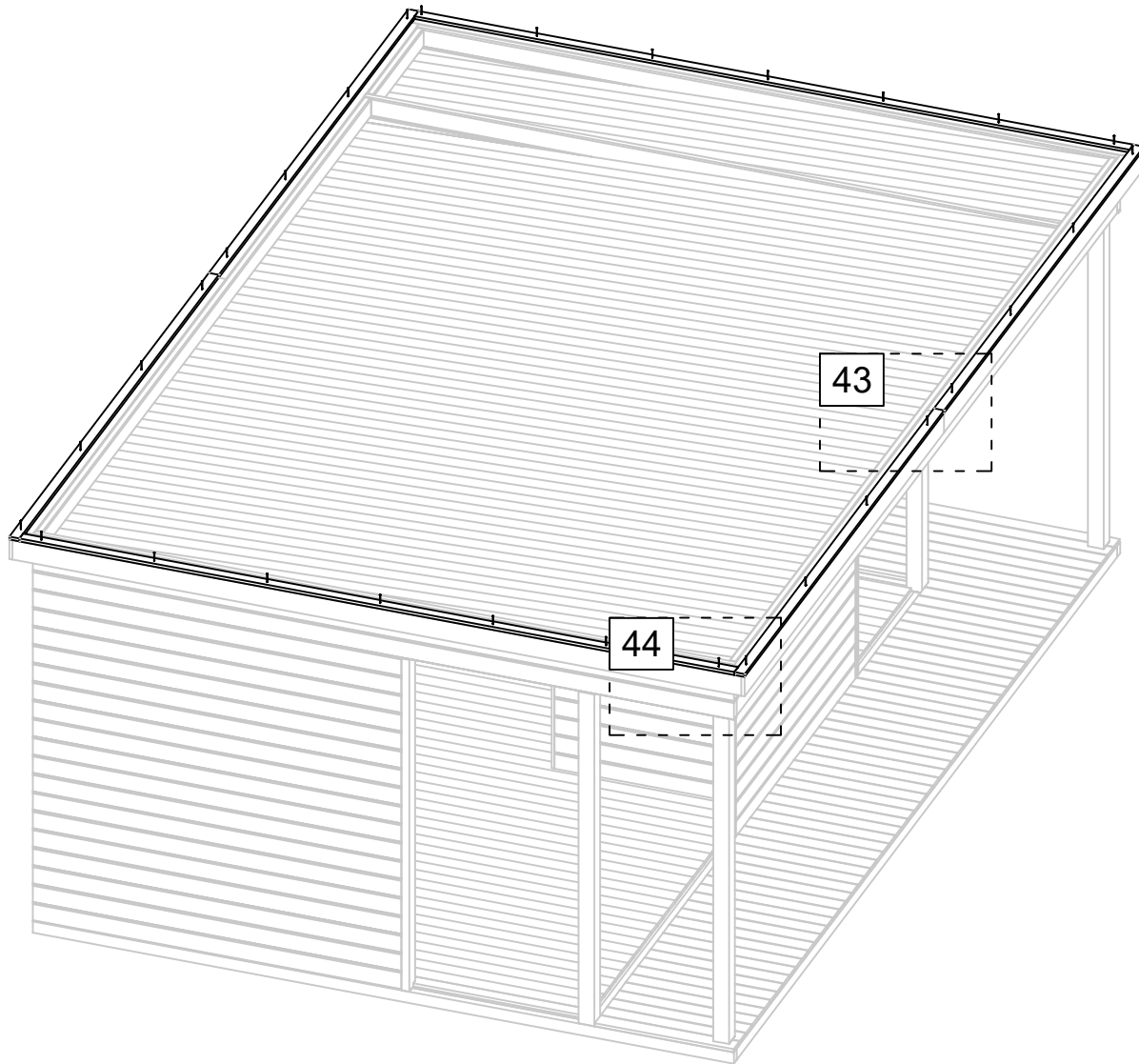

43

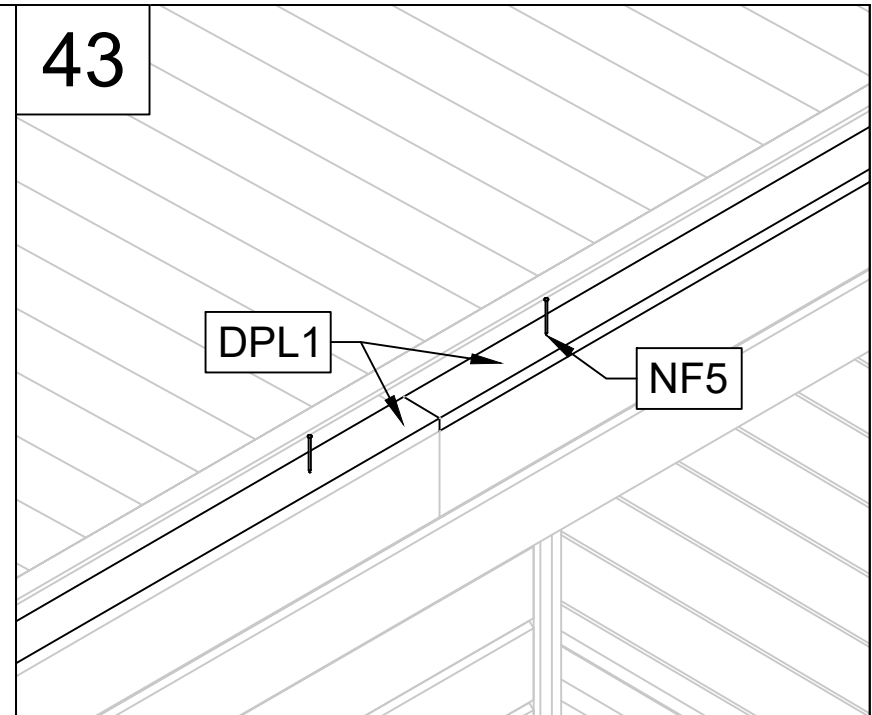

44

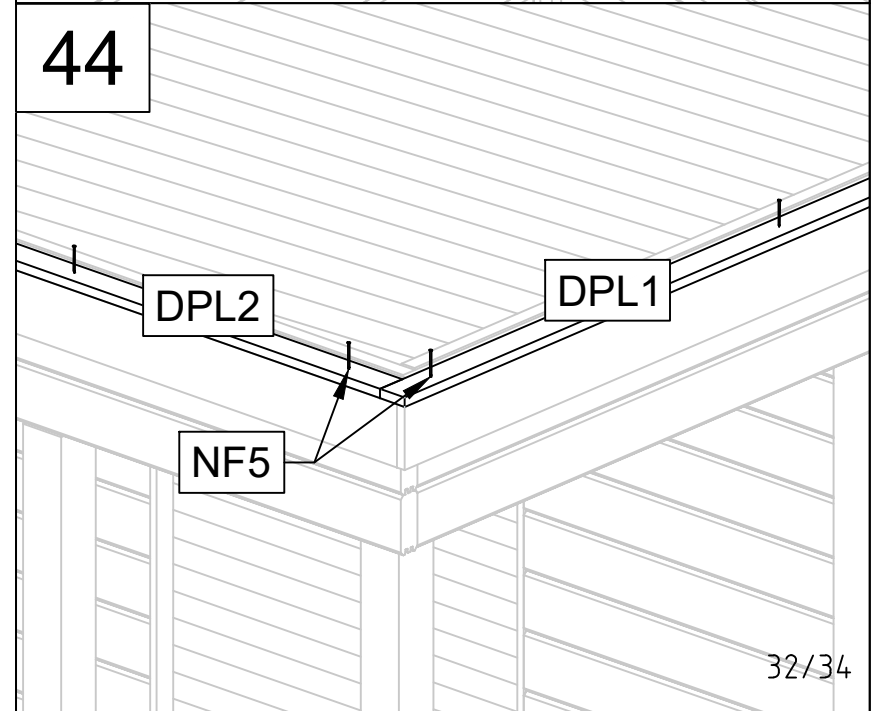



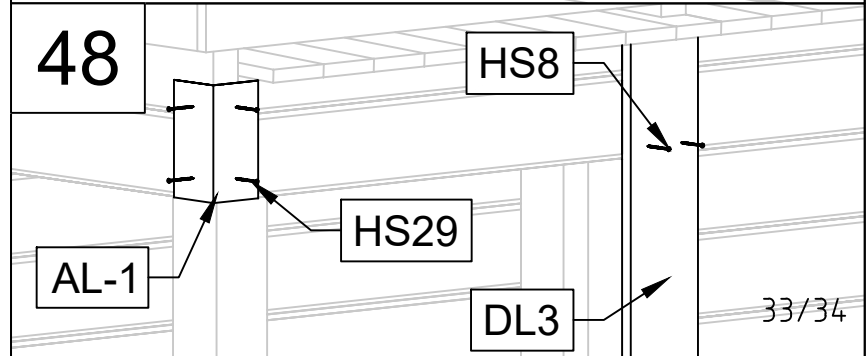
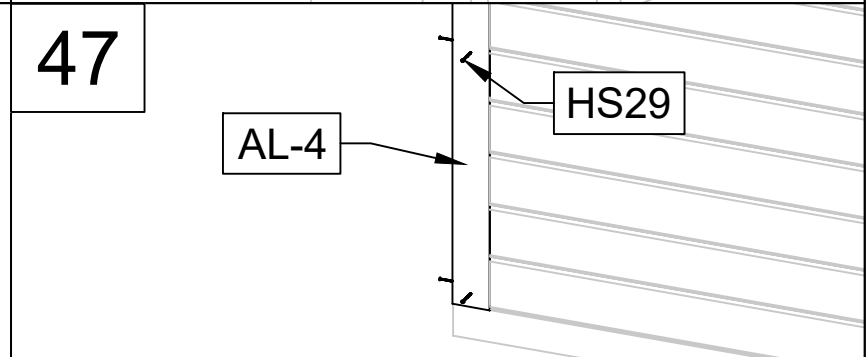
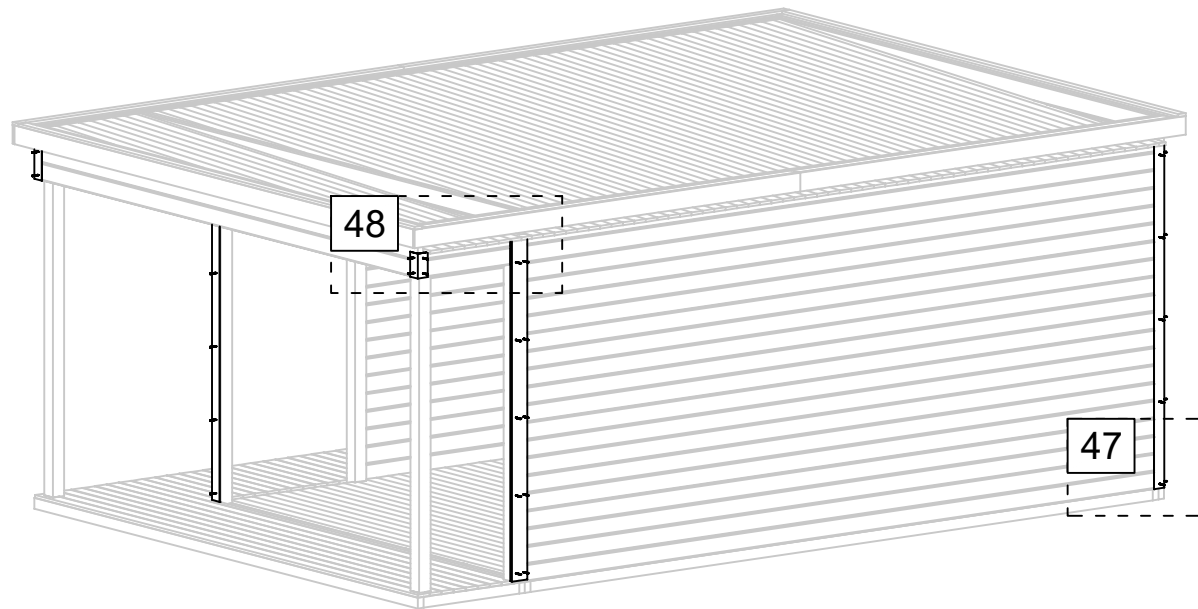
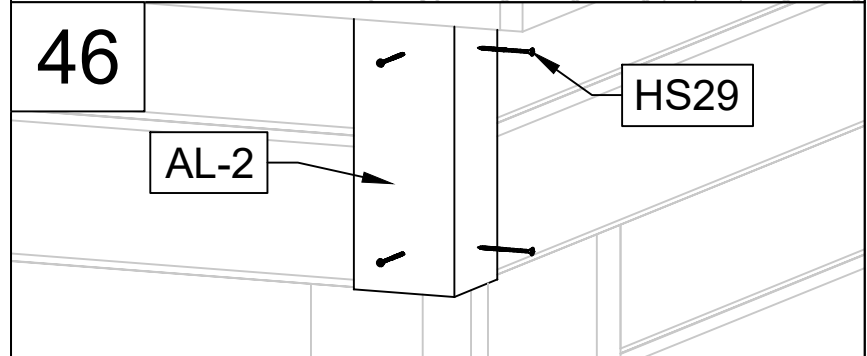
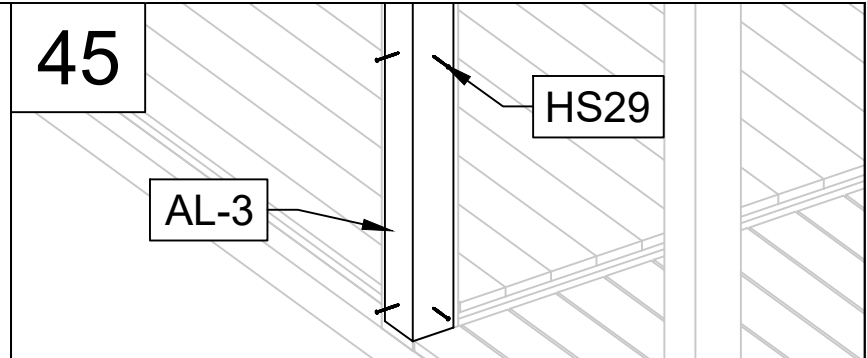
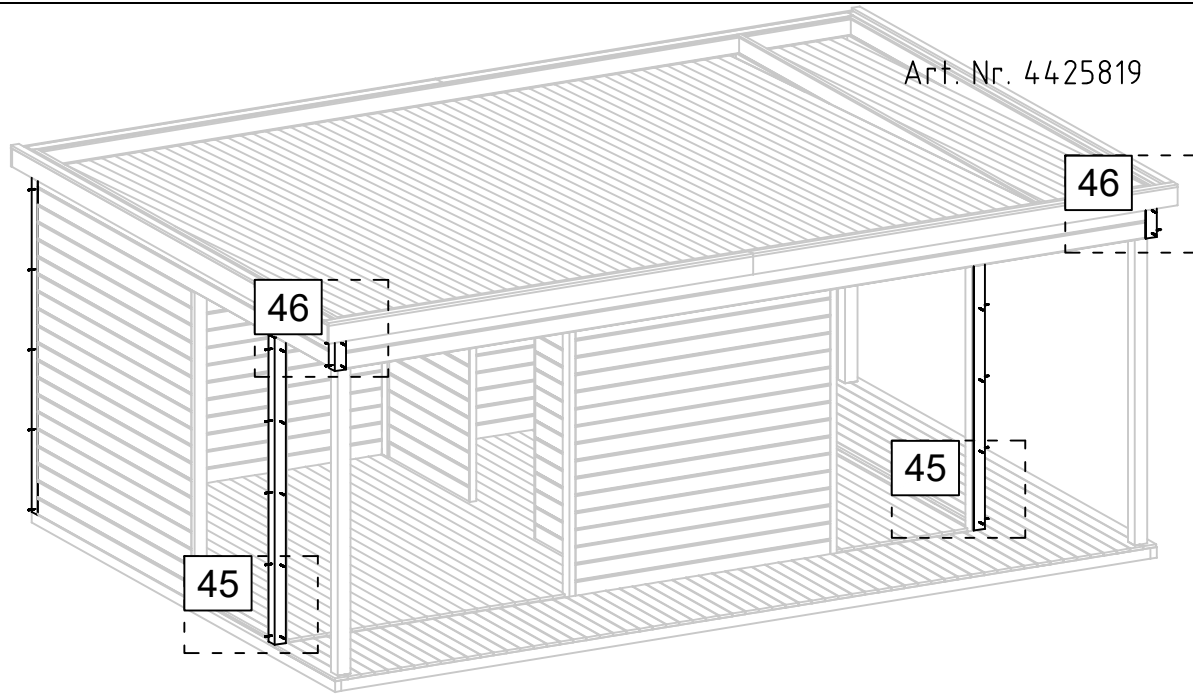

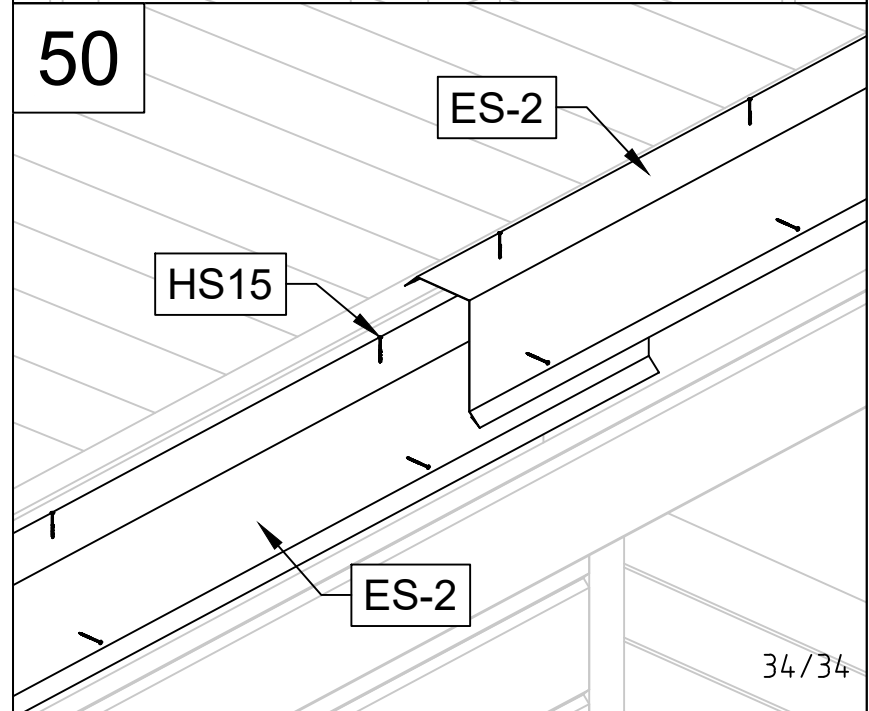
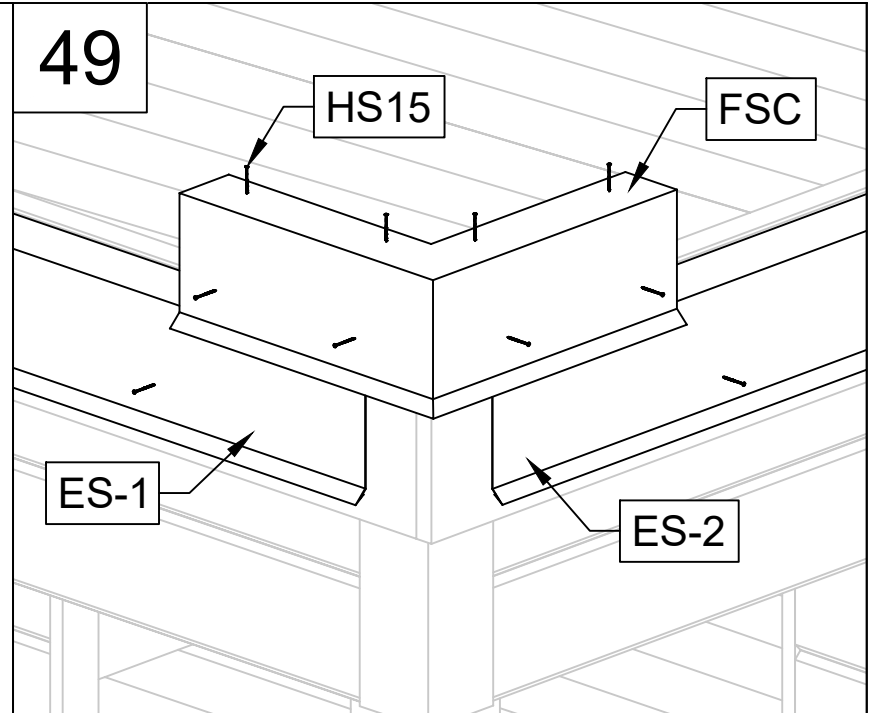
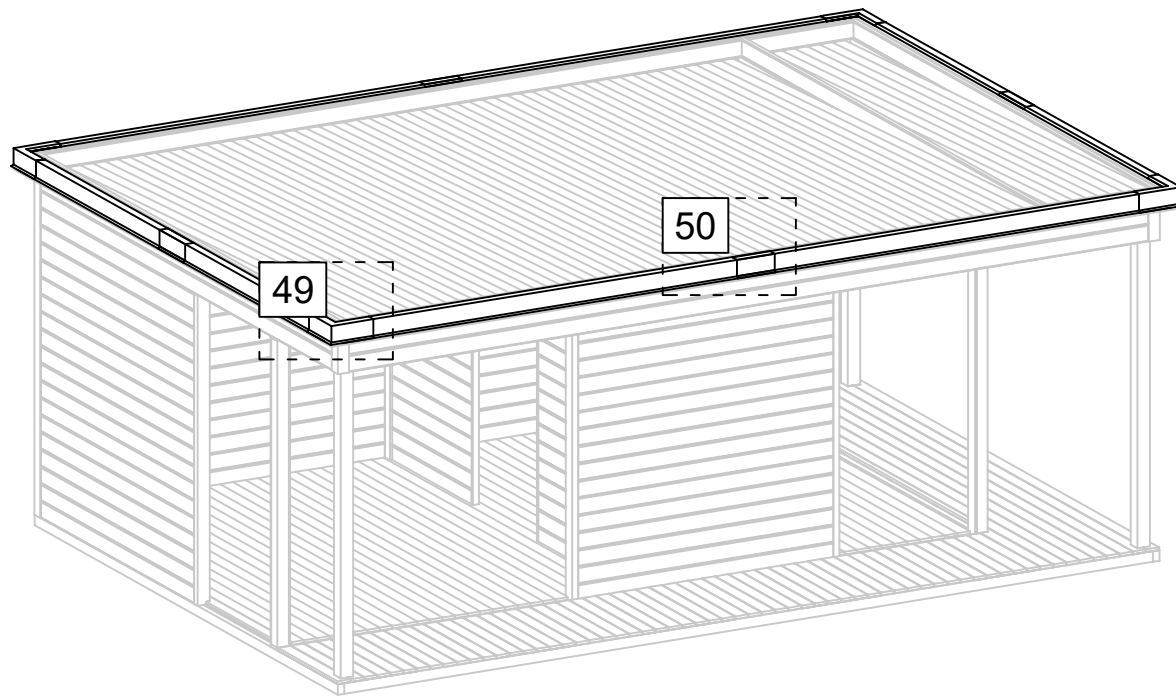

Art. Nr. 4425819

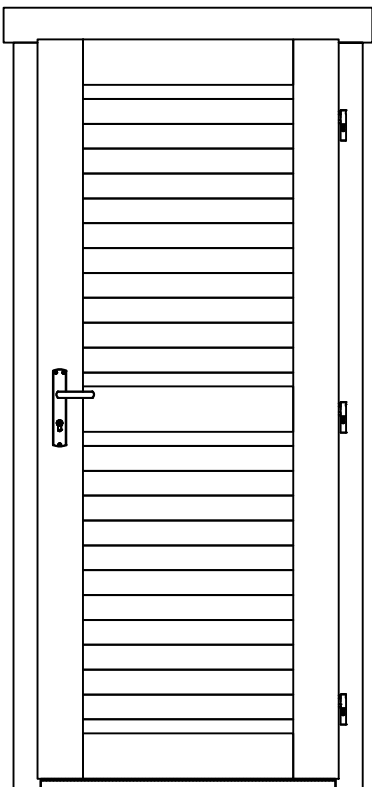
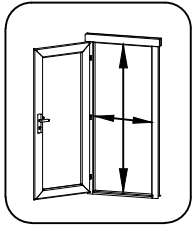
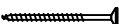

Art. Nr. 4425819

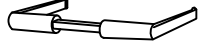

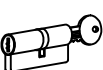
Pos	12.05.2016	Piece list - Stückliste - Liste des pièces - Elementi - Stuklijst - Tükítabel 835x1957 UL.2.100.IVP.MM TP+	1/1	Q	P (mm)	L (mm)
						
						 735 x 1873 mm
HS16	Screw for door jamb - Schraube für türrahmen - Vis de fixation partie haute avec montants du cadre de porte - Viti x fissaggio montanti porte - Schroef voor deurkozijn - Kruvi ukse lengile		4	5x90		
HS25	Screw for doorstep - Schrauben für swelle - Vis pour fixation barre de seuil - Vite per soglia della porta - Schroef voor deurdorpel - Kruvi lävepakule		2	4.5x65		
HC	Covers for door hinges - Schutzkappe für türband - Couverture de paumelle de porte - Copertura delle cerniere della porta - Afdek kap voor deurscharnier - Reguleeritava polthinge kate		6			
MH	Male bolt hinge for door - Türband - Partie male de paumelle de porte - Cerniera anube x porta - Scharnier bout - Reguleeritav polthing isane		3	14x80		
TL4	Door handle fittings - Türgriff - Poignée de porte - Maniglie - Deurhendel / klink - Ukse käepide		1			
TL5	Set of door lock covers - Schlossblenden - Set de garnitures de porte - Copertura serrature - Slot sluitplaat set - Ukse lukuplaat		1			
	Cylinder lock - Zylinderschloss - Barillet de porte - Serratura - Cylinder slot - Ukse lukusüdamik		1	30x35		