

Ilmenau
Art. Nr. 442300
1/18



08.06.2018

Art.Nr. 442300

Groundplan - Grundplan - Plan de masse -
Planimetria - Plattegrond - Põhiplaan

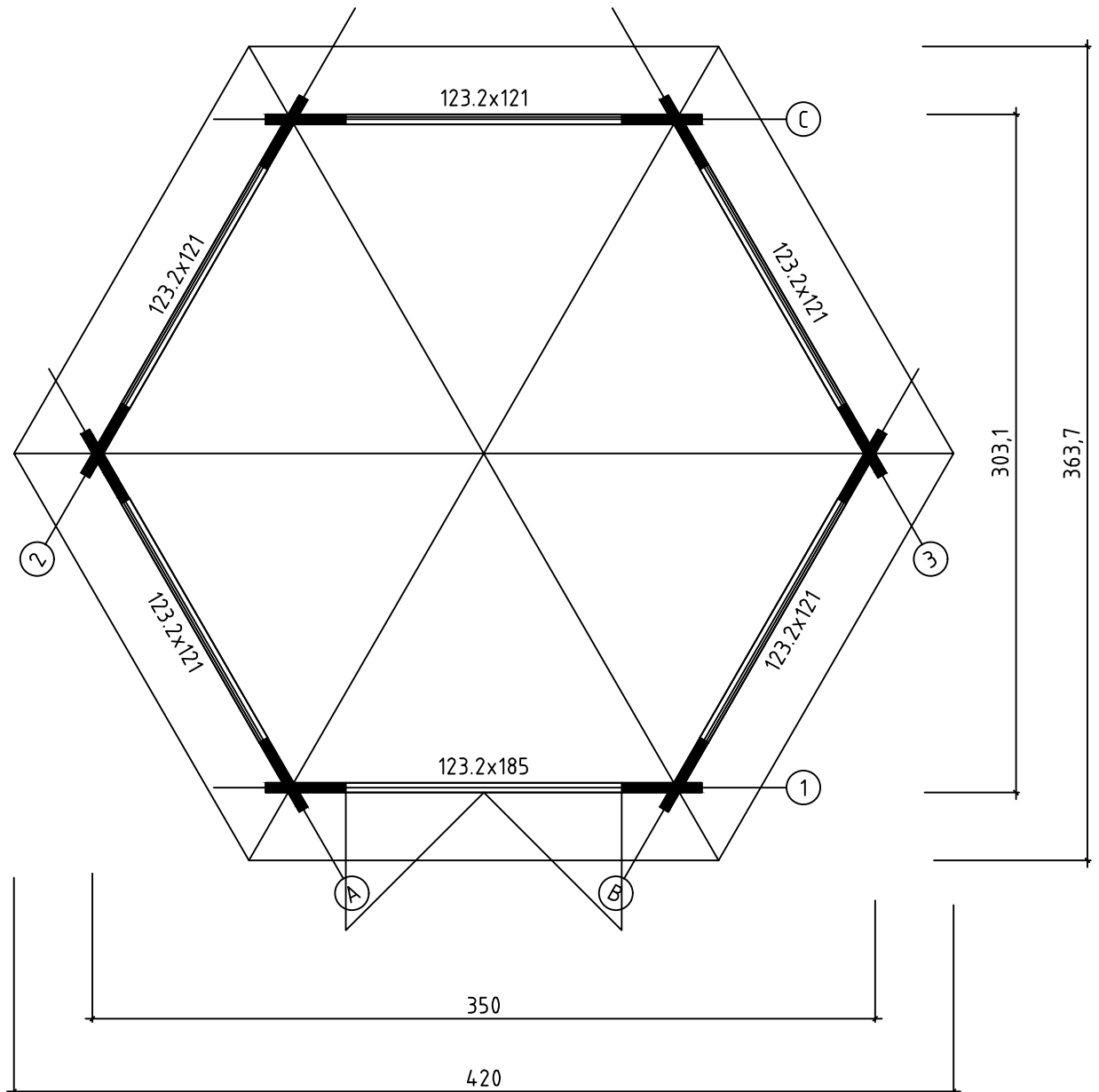

Art.Nr. 442300

Foundation - Fundament - Fondation -
Fondamenta - Fundering - Immutatud alusraam

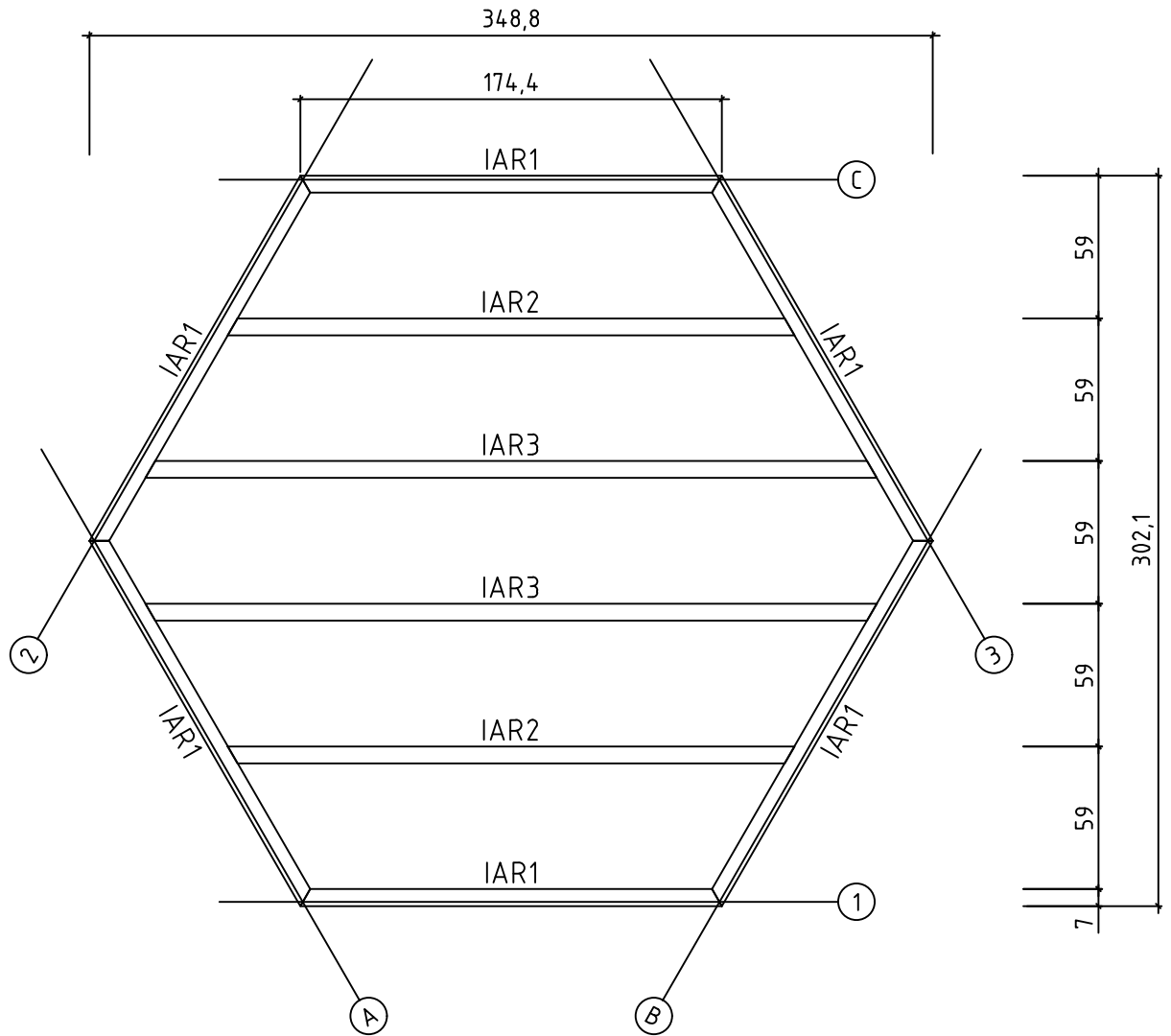

Art.Nr. 442300

Floor boards - Fussbodenbretter - Plan pose plancher -
Pavimento - Vloerhout - Põrandalaudis

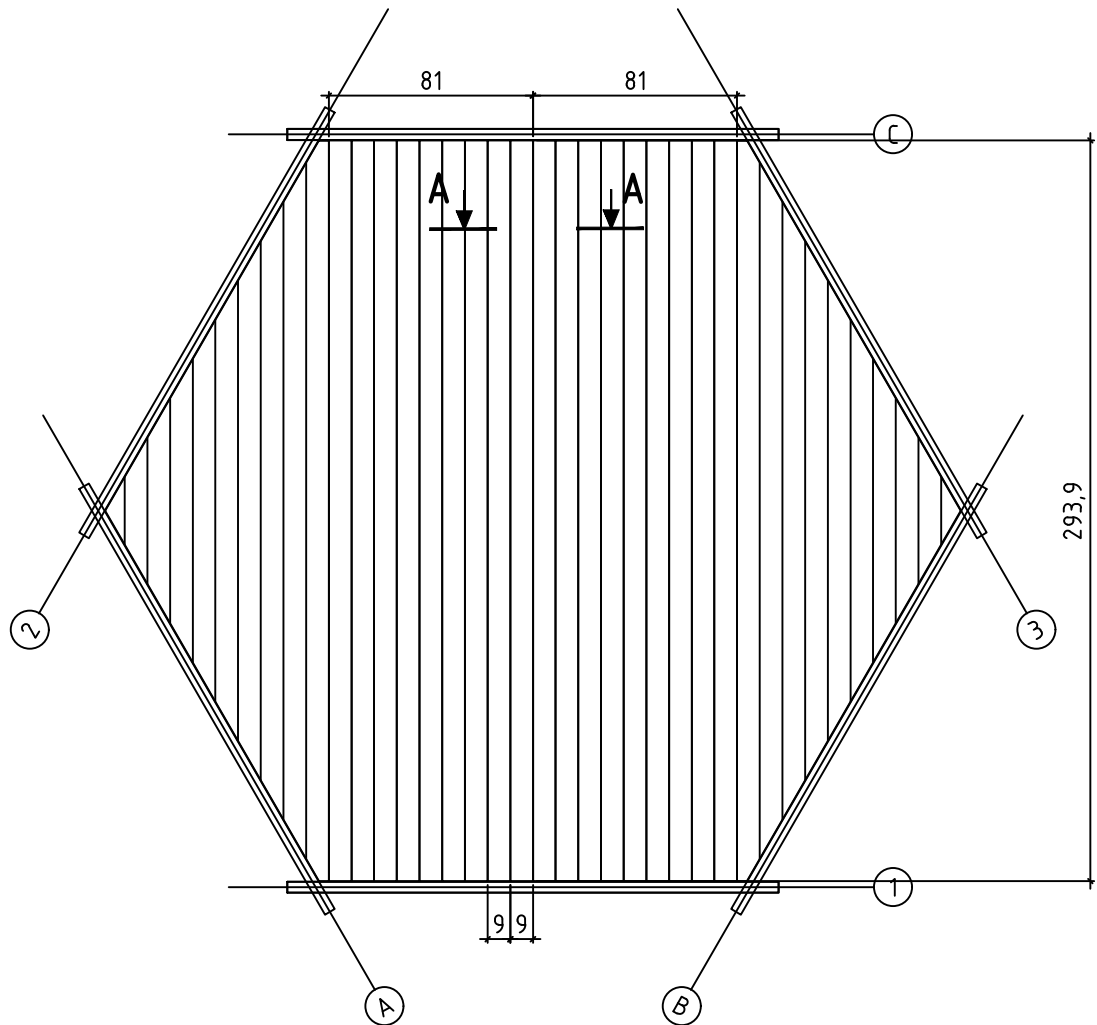

A - A

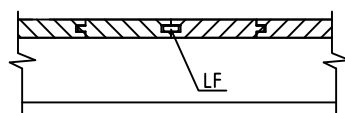

Art.Nr. 442300

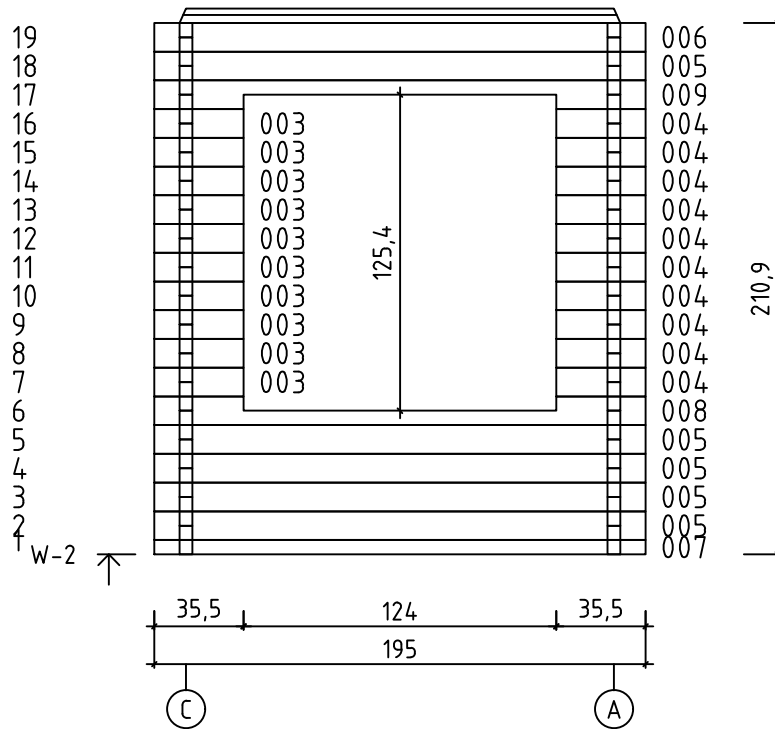
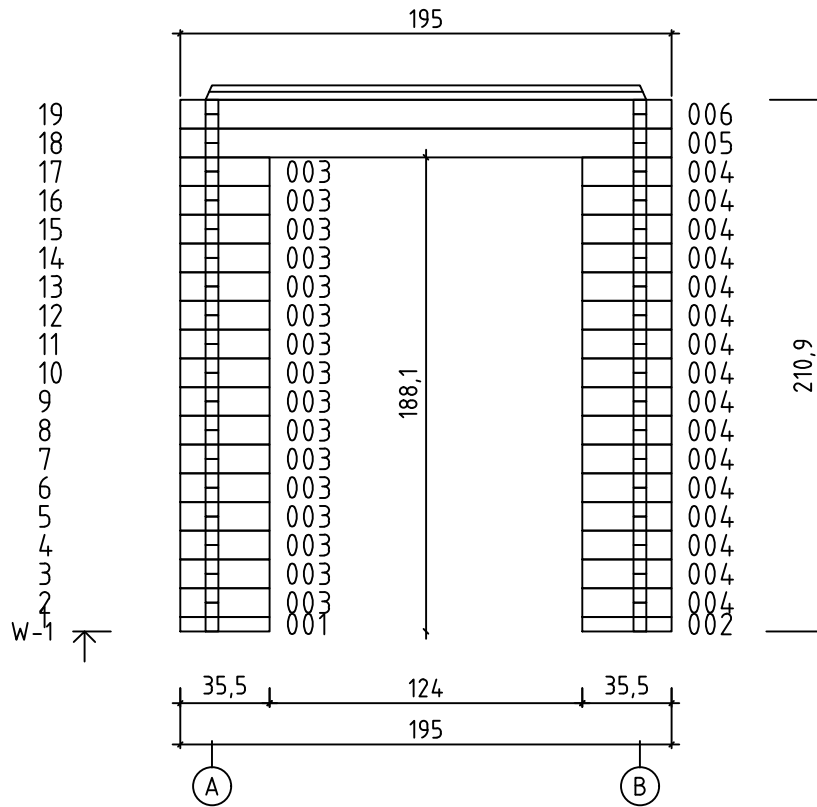

Art.Nr. 442300

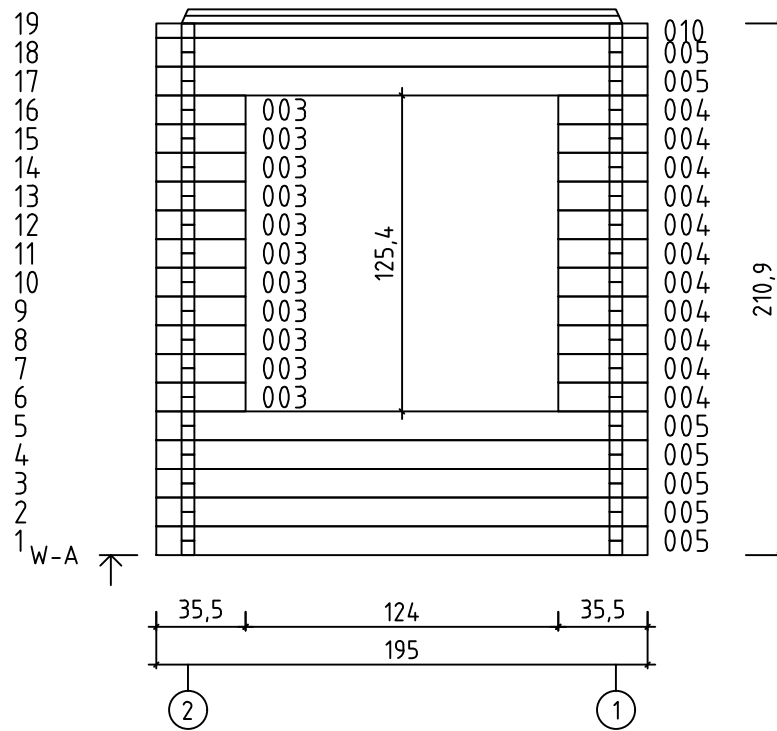
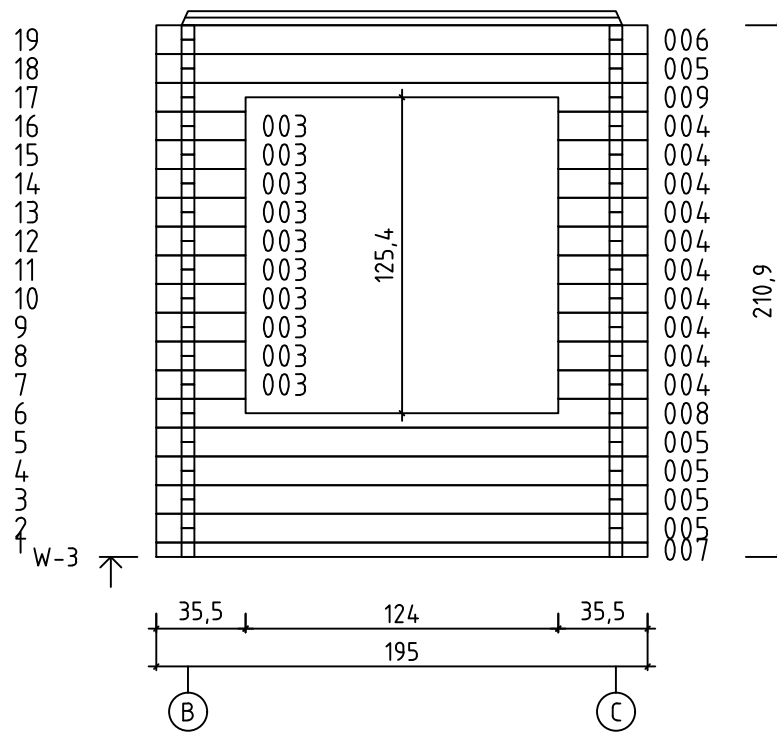

Art.Nr. 442300

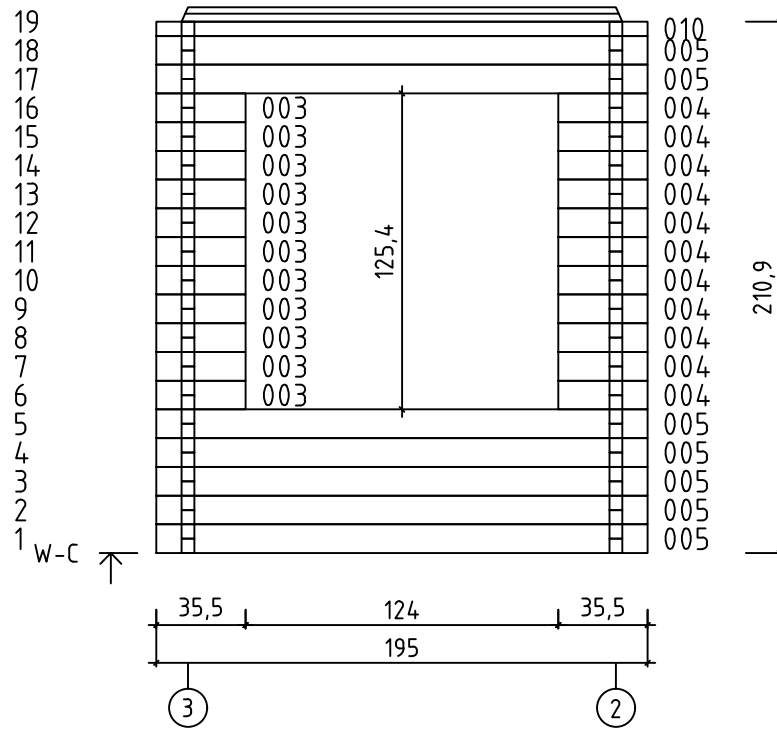
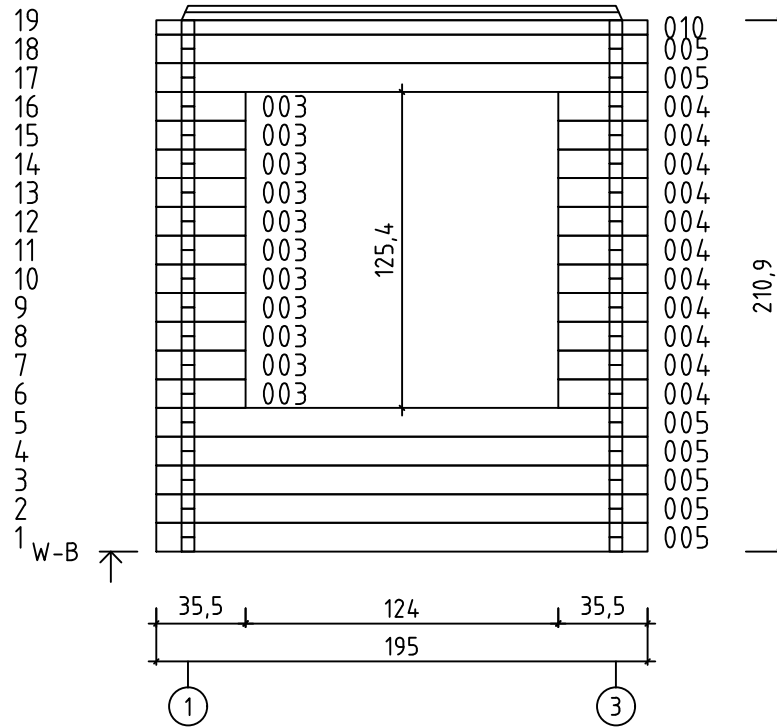

Art.Nr. 442300

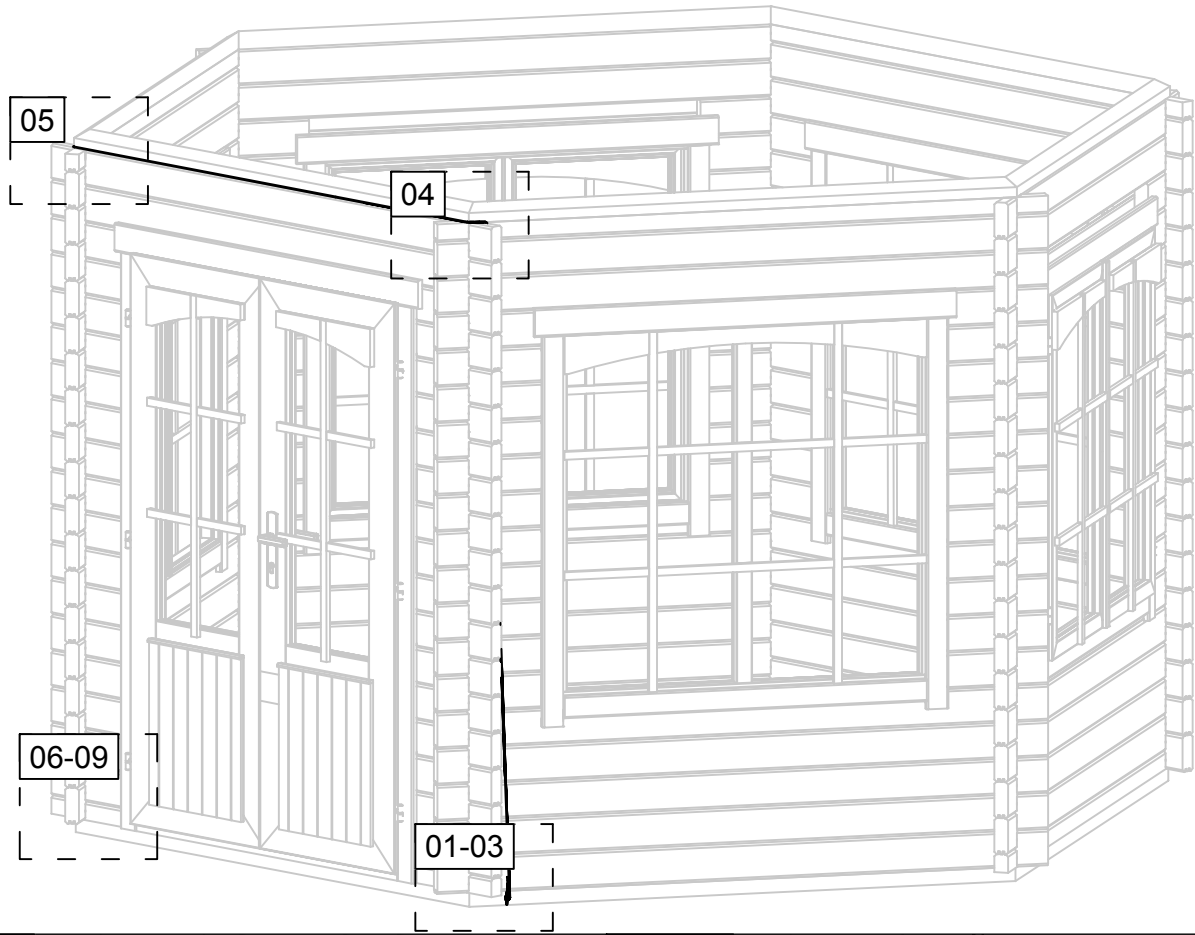

01

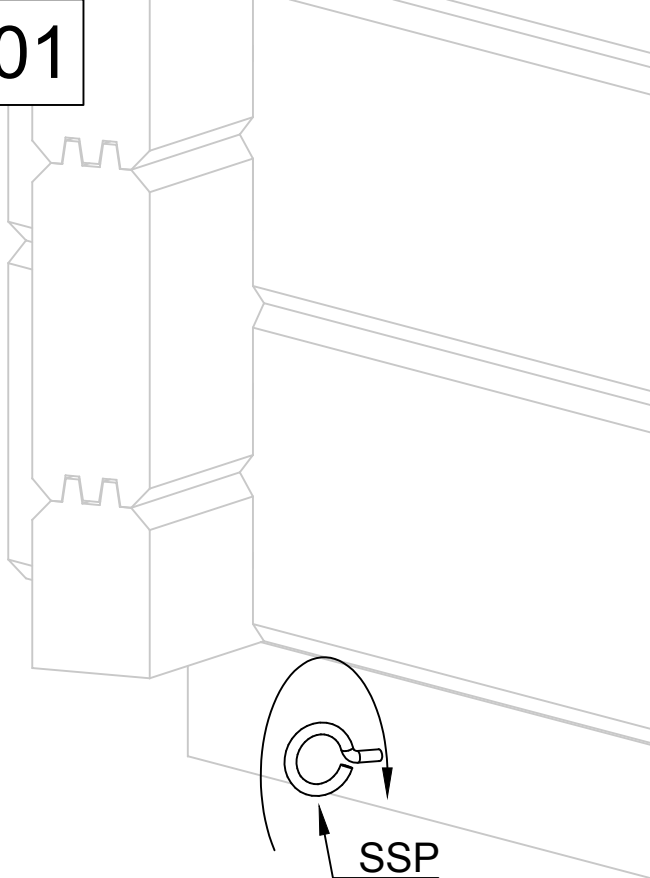

02

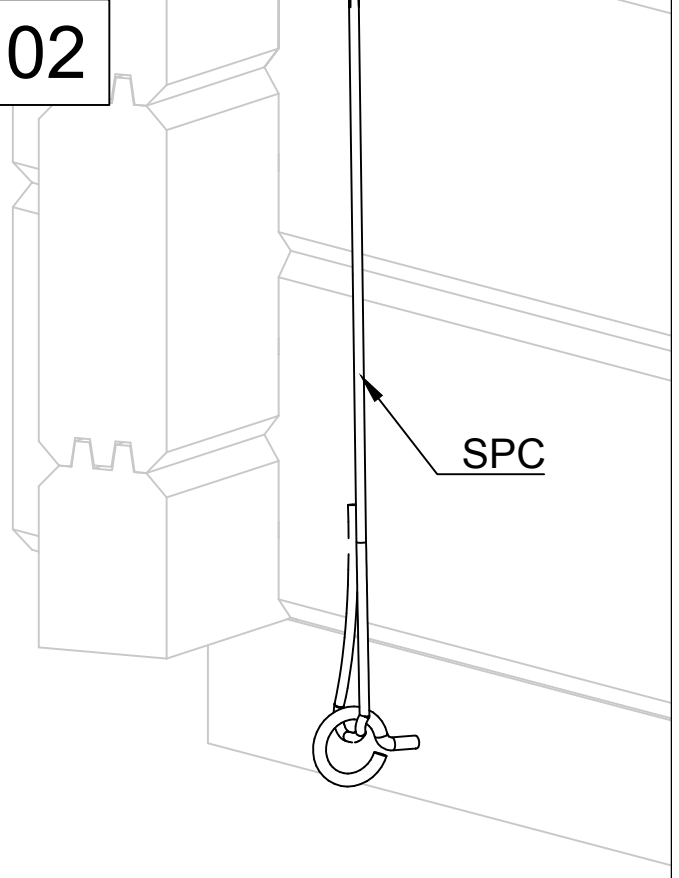

08.06.2018

8/18

03

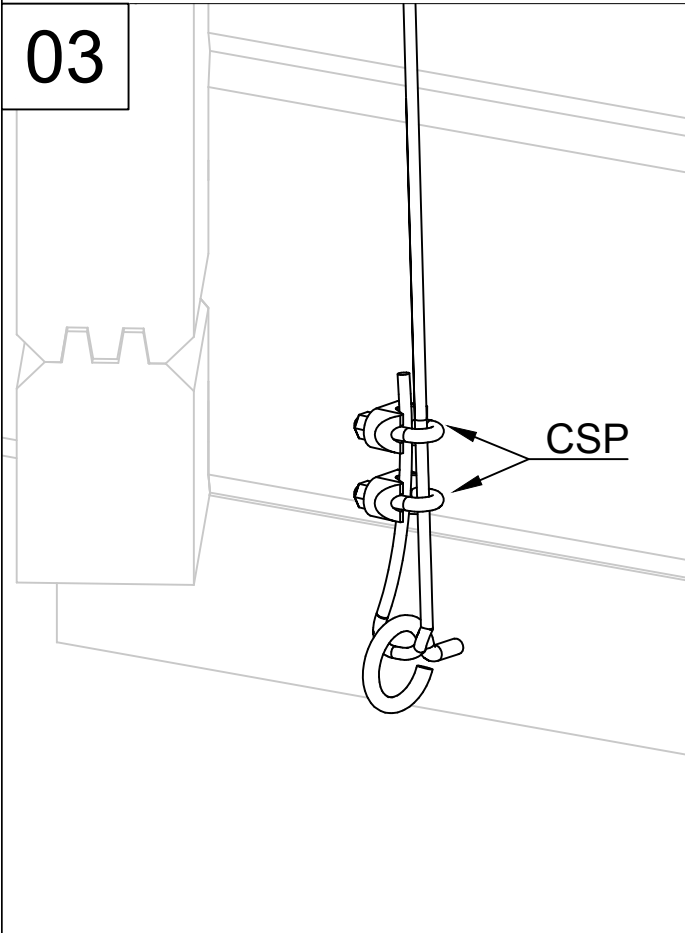

04

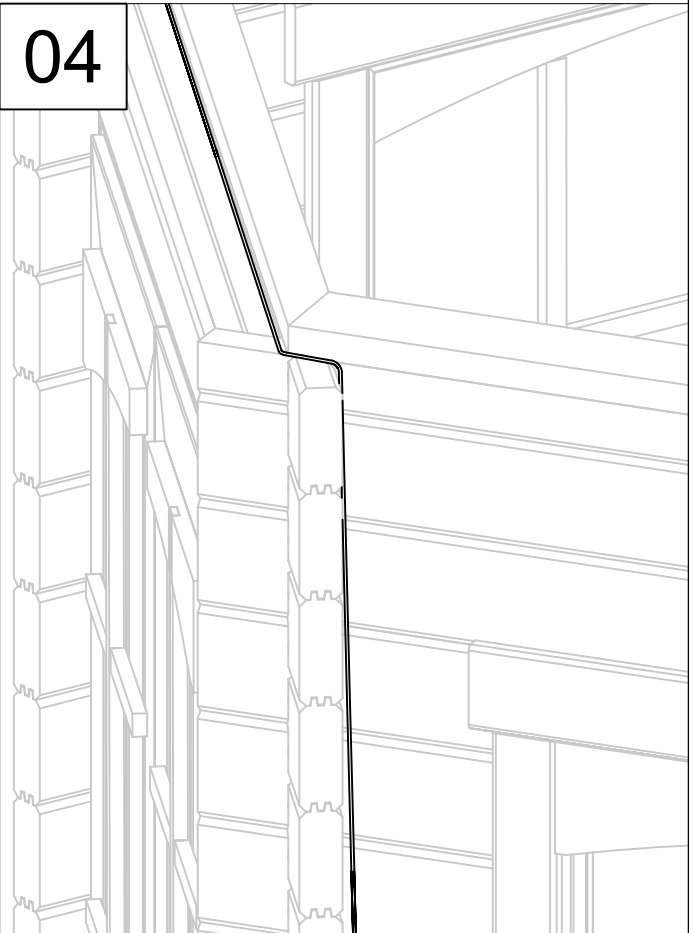

05

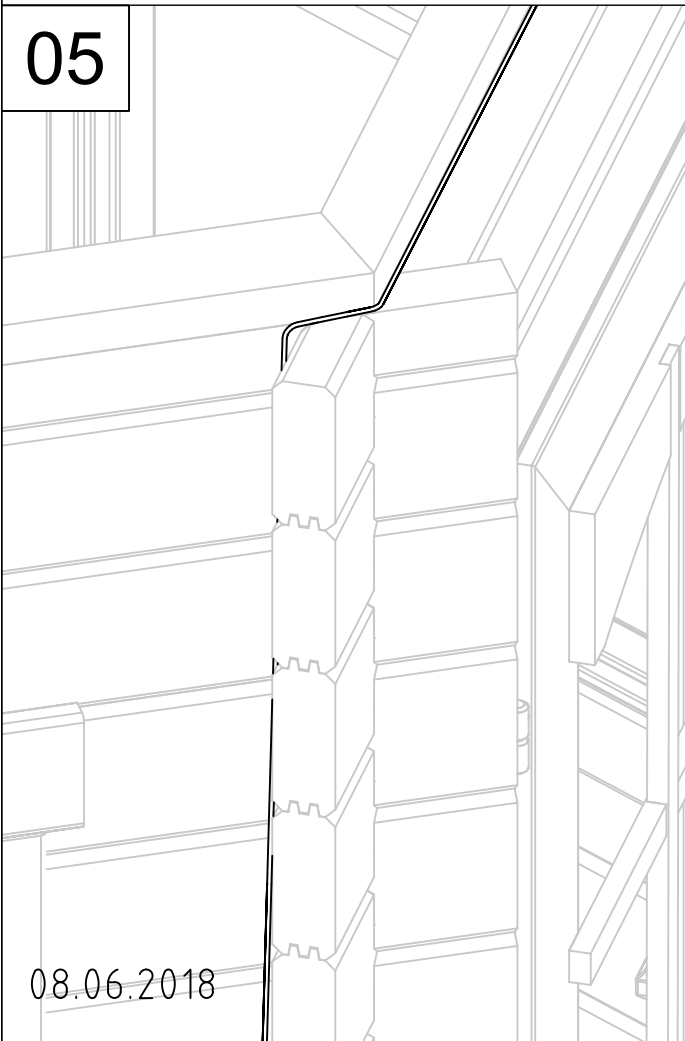

06

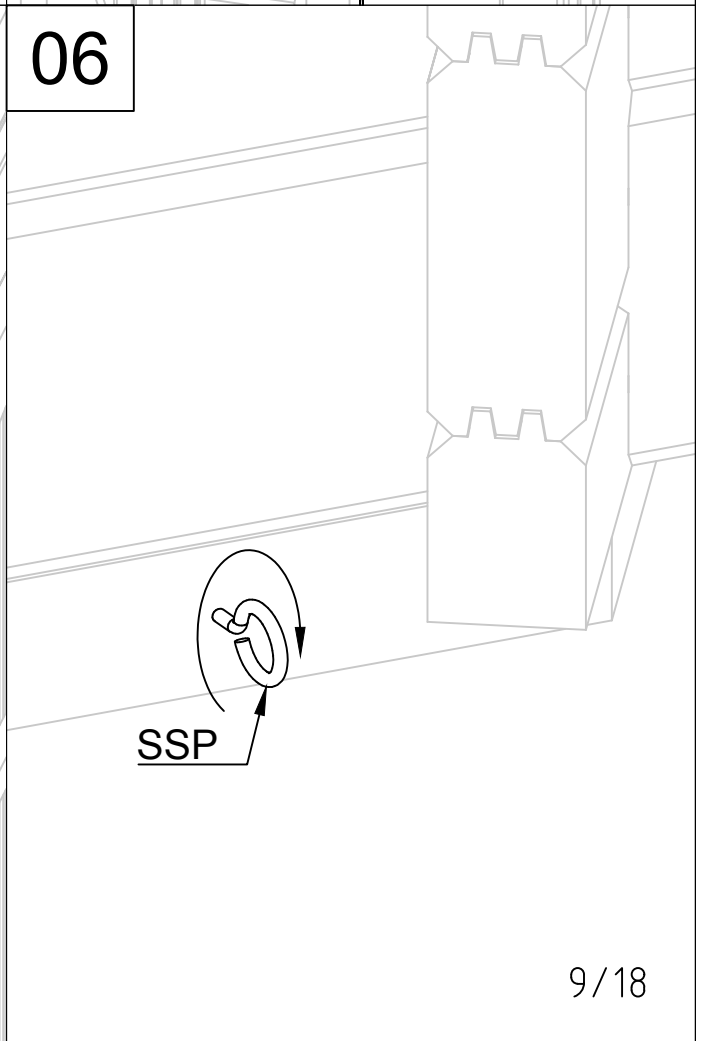

07

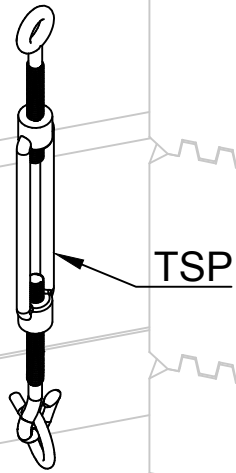

08

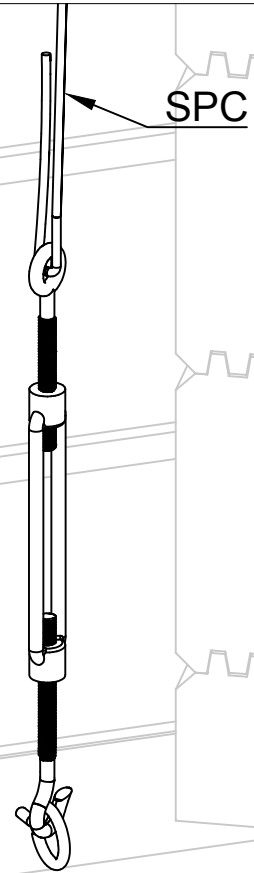

09

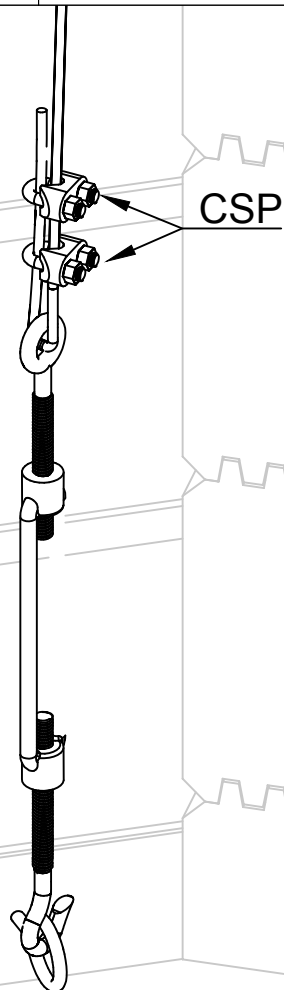

Art.№. 442300

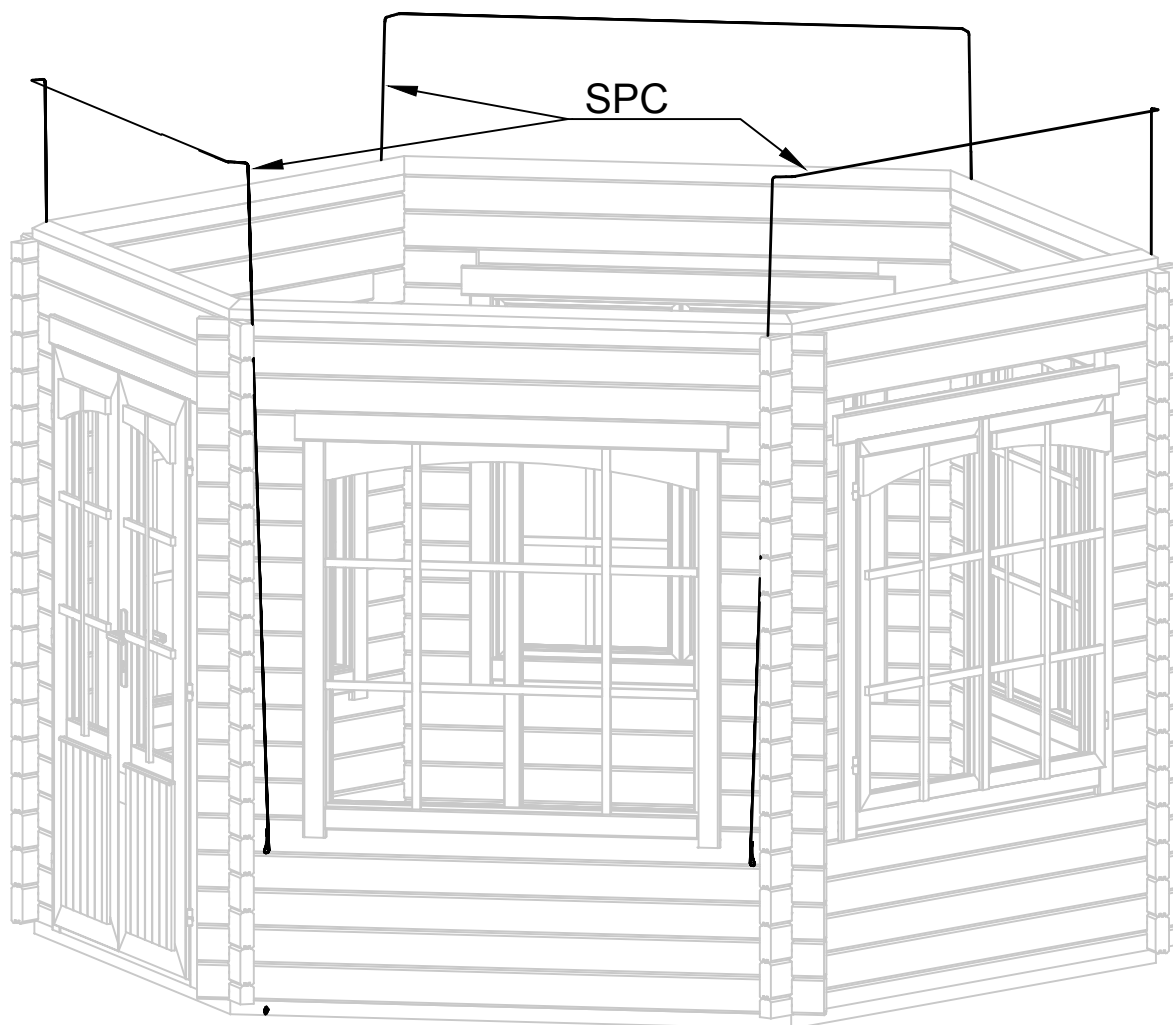

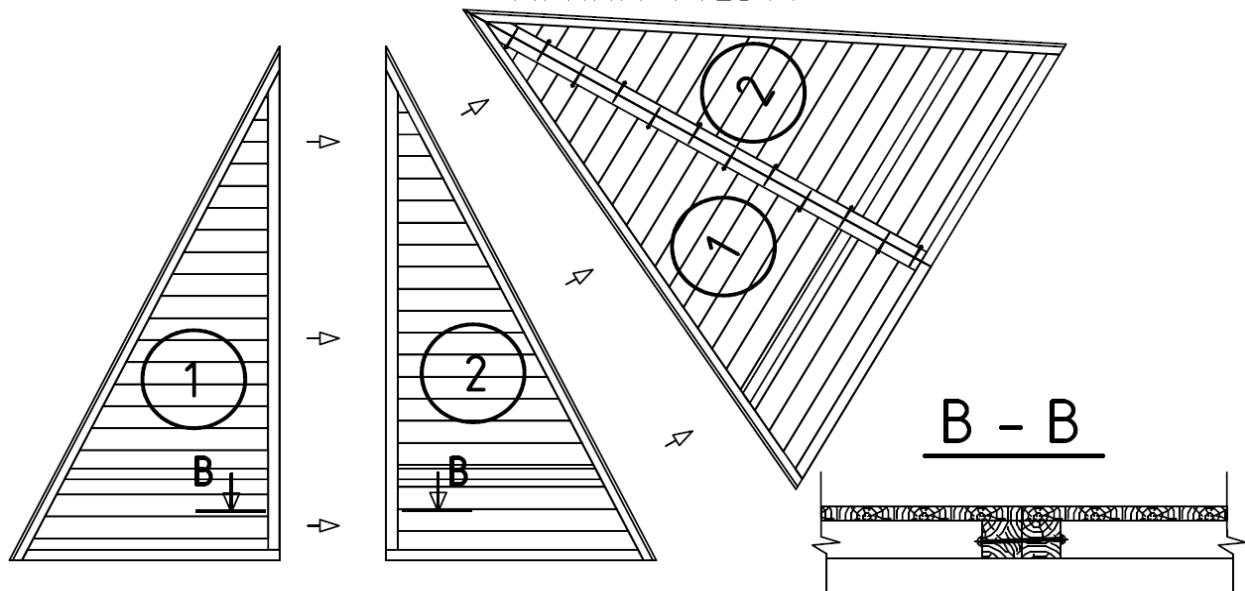

Attach left and right (1&2) roof panels together, using 2 screws HS1 (12 pcs total) at the lowest part (B-B). Then at regular intervals using the remaining 10 screws, attaching them on alternating sides.

Verbinden sie die linke und rechte (1&2) dachfläche mit den schrauben HS1 (12 stück insgesamt) beginnend an der tiefsten stelle (B-B). dann in regelmäßigen abständen die restlichen schrauben von beiden seiten bis hin zur spitze anbringen.

Assembler les panneaux de toit 1 et 2 avec les vis (HS1-12 vis au total) en les répartissant à intervalle régulier comme le montre le dessin ci-dessous.

Unire i pannelli del tetto 1 e 2 mediante le viti "HS1". Cominciate a fermare i pannelli con 2 viti e quindi finite di bloccarli con le restanti 10 ad intervalli regolari, come mostrato nella figura qui sotto (ne servono 12 in totale)

Voeg het linker-(1) en het rechterdakpaneel (2) samen. Gebruik 2 HS1 schroeven (12 stuk in totaal). Schroef deze 2 schroeven op de B-positie. Schroef vervolgens de overige 10 schroeven aan weerszijden vast.

Kinnitage vasak ja parem (1&2) katusekilp omavahel, alustades kilpide madalaimast osast (lõige B-B), kasutades kahte HS1 kruvi (kokku: 12tk.). Ülejäänud kümme kruvi kinnitage kindla sammuga vaheldumisi kilbi kummaltki poolelt.

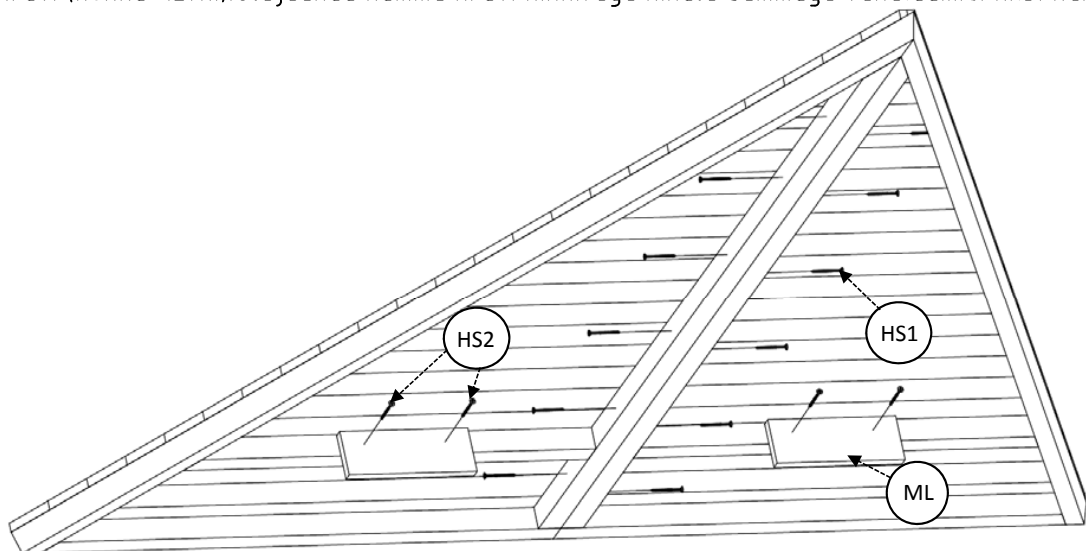

Using 2 screws (HS2) attach ML to the lower part cross batten on the underside of the roof panel (these are temporary supports).

Mit den zwei schrauben (HS2) befestigen sie die komponente ML auf dem unteren rahmenteil. Hierbei handelt es sich um stützen zur befestigung der dachflächen

Pour la mise en place des panneaux de toit, veuillez visser temporairement les détails ML aux traverses intermédiaires avec les 2 vis (HS2) pour chaque détail ML une fois la mise en place de la toiture terminée, vous pourrez les enlever.

Per posizionare i pannelli del tetto, fissate provvisoriamente gli elementi ML alle traverse intermedie usando n.2 HS2 viti cadauno. Terminato il montaggio del tetto potrete rimuovere gli elementi ML.

Gebruik 2 schroeven (HS2) en scoef deze op positie ML op het onderste gedeelte vast op de onderkant van het dakpaneel. Dit is ter tijdelijke ondersteuning.

Kinnitage detail ML katusekilbi raami külge, kasutades kahte HS2 kruvi (need on ajutised toed).

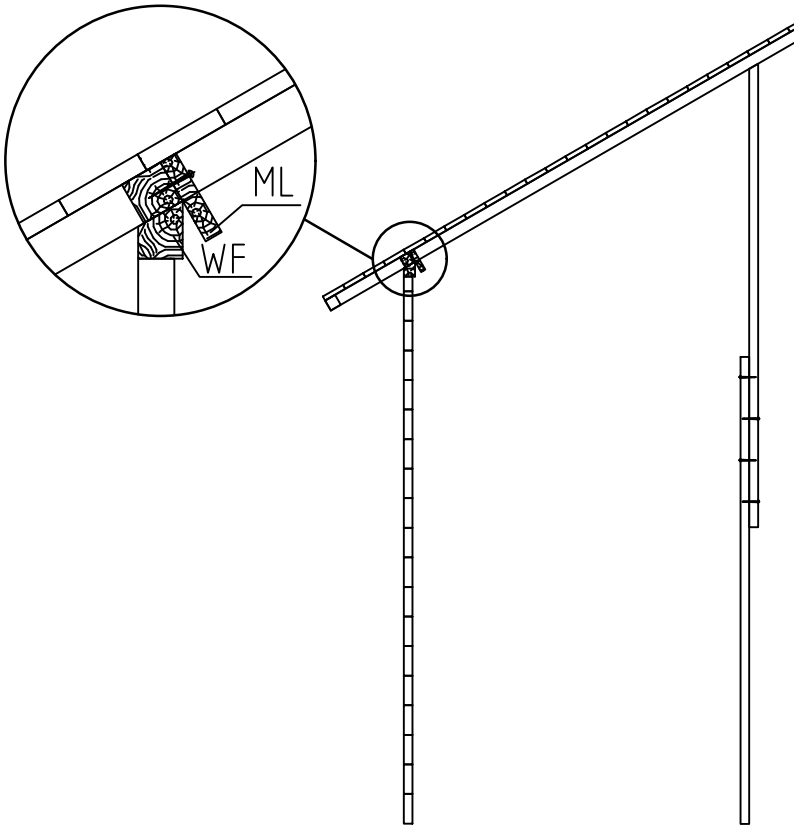

Attach together parts AB so that the entire length is 2990 mm using 4 screws provided HS3. This is a temporary support to help you mount the roof.

Verbinden sie die beiden komponenten AB mittels der vier schrauben HS3 miteinander. So dass die länge 2990 mm beträgt. Hierbei handelt es sich um eine temporäre stütze zur installation der dachflächen.

Pour la mise en place des panneaux de toit, veuillez visser avec 4 his (HS3) les supports de maintien de toit AB ensemble de telle sorte a obtenir un poteau d'une hauteur totale de 2990 mm. Une fois la mise en place de la toiture terminée, vous pourrez l'enlever.

Voeg de onderdelen AB samen zodat de totale lengte 2990 mm is. Gebruik 4 schroeven (HS3). Dit is een tijdelijke bevestiging om je te helpen het dak te bevestigen.

Proseguite l'assemblaggio dei pannelli del tetto fissando con n 4 viti HS3 i supporti provvisori di sostegno del tetto AB in modo da ottenere un palo alto cm 299, che vi aiuterà nel posizionamento degli stessi pannelli, dopo di che potrete smontarlo.

Kasutades nel ja HS3 kruvi,kinnitage detailid AB nii, et kogupikkus on 2990 mm. See on ajutine tugi katusekilpide paigaldamiseks.

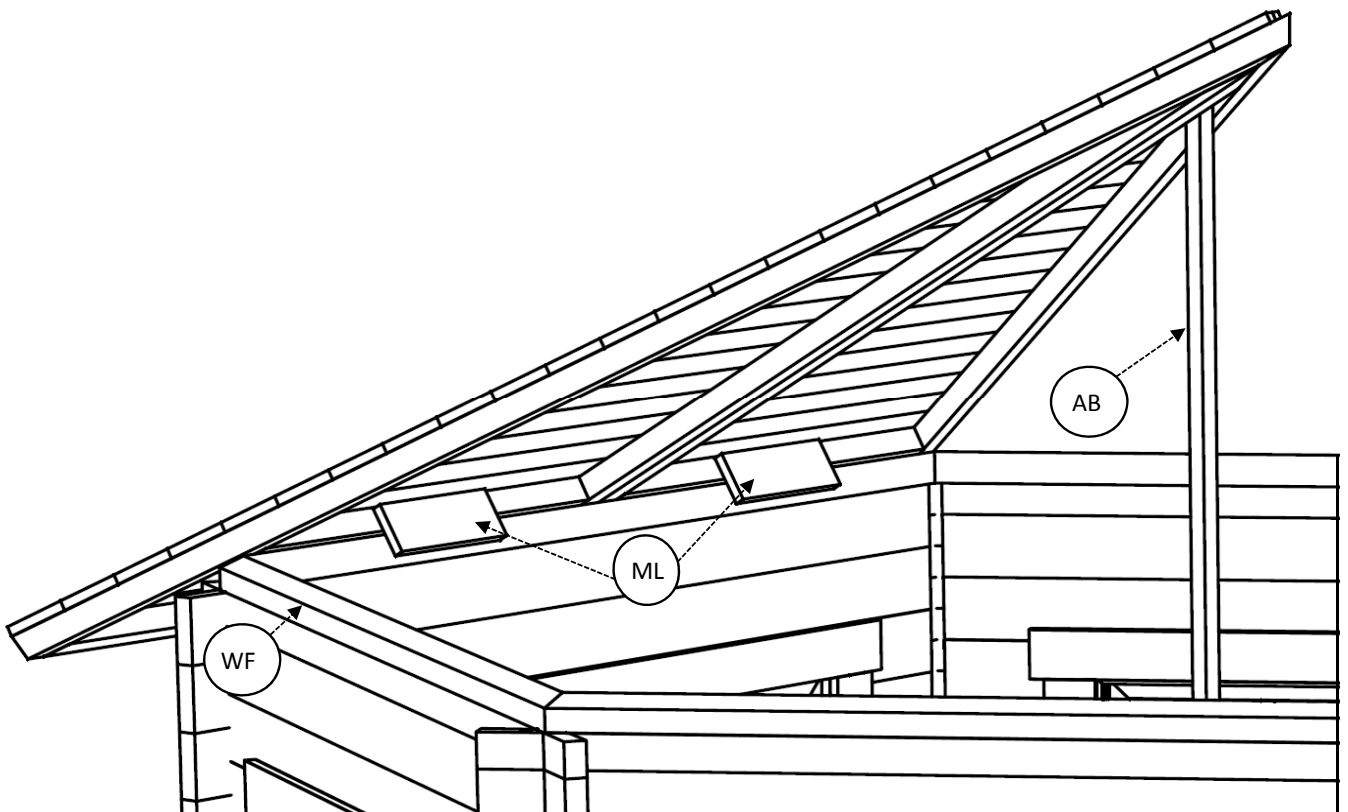

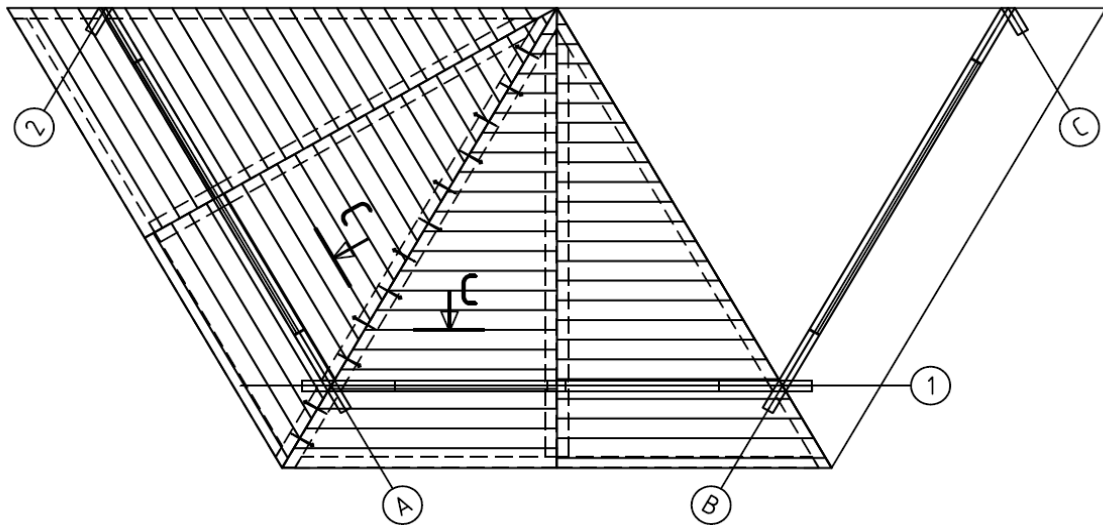

Mount the first roof section you have created next to the second one (C-C), (with the help of roof support AB)-making sure they are aligned and using screws HS1 (12pcs) screw alternate sides all the way up, (do not tighten until all panels have been attached, you may need to adjust the positioning and height at the end). Once the correct positioning has been achieved tighten all screws.

Montieren sie nun nacheinander die einzelnen dachflächendreiecke unter zuhelfenahme der stütze AB. Verbinden sie die einzelnen dreiecke wieder mit den schrauben HS1 (12 st.) vom boden bis zur spitze. die schrauben bitte nicht sofort fest anziehen, so dass sie die dachelemente ggf. noch justiert werden können. nachdem alle deiecke an seiner korrekten position sind und das dach justiert wurde, bitte die schrauben fest anziehen.

Placer sur le toit les éléments de toit préassemblés côte à côte (C-C), en vous aidant du poteau de maintien de toit AB. Assurez-vous de leur bon alignement et visser les ensemble à intervalle régulier en utilisant les vis HS1(12 vis pour fixer à chaque fois 2 panneaux). Attention, ne pas visser à fond tant que tous les panneaux ne sont pas mis en place, car vous aurez peut-être besoin d'ajuster le positionnement de certains d'entre eux. Une fois tous les panneaux de toit mis en place correctement, alors visser à fond.

Posizionate sul tetto le coppie di pannelli precedentemente avvitate (C-C) aiutandovi con il palo precedentemente assemblato AB. Assicuratevi che siano ben allineate, quindi fissatele senza avvitare a fondo le viti. Utilizzate n. 12 viti HS1 ad intervalli regolari per ogni lato da unire. Controllate che le coppie dei pannelli siano posizionate perfettamente tra loro, quindi avvitate a fondo le viti!

Bevestig de eerste dak sectie die je gemaakt hebt naast de 2e (C-C) met behulp van de dak ondersteuning (AB). Zorg dat de onderdelen evenredig verdeeld zijn en maak gebruik van de HS1 schroeven (12 stuks). Schroef de dak sectie afwisselend aan beide kanten naar boven toe vast. Doe dit niet te strak totdat alle secties bevestigd zijn. Aan het eind kun ja dan nog de positie en de hoogte aanpassen. Als dit gedaan is wel de schroeven wel stevig aan draaien.

Tõstke üks monteeritud katusekilp teise kõrvale (C-C), (montaažilati AB abiga)-veenduge et katusekilbid oleks kohakuti ja seejärel kasutades kruvi HS1 (12tk.) kinnitage kindla sammuga vaheldumisi kilbi kummaltki poolelt.



Art.Nr. 442300

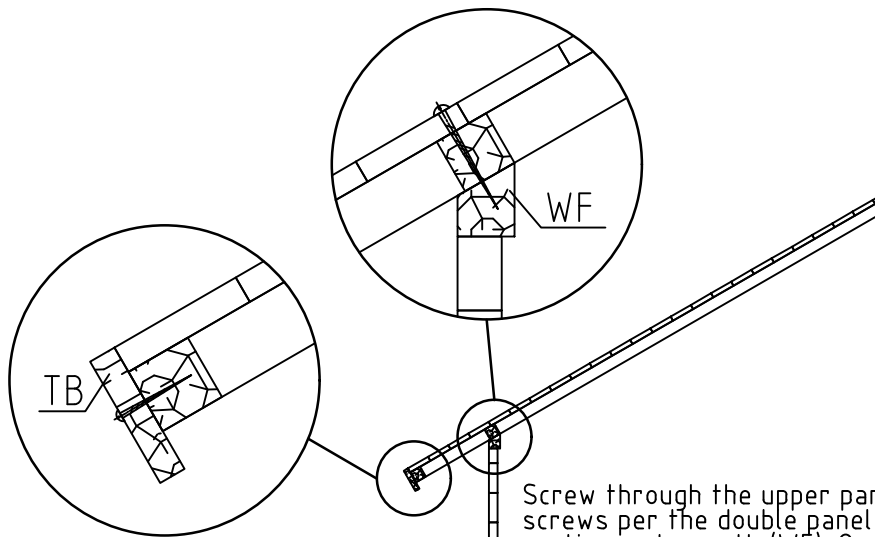

Under the eaves of the roof edge attach the fascia board TB using screws provided HS5 (3pcs).

Anschließend bringen sie bitte die umlaufenden abschlußbretter (TB) mittels der drei schrauben HS5 jeweils am unteren rahmenteil der dachflächendreiecke an.

Fixer les planches de rives TB aux extrémités visibles des panneaux de toit avec les vis HS5 (3 vis par planche).

Fissate il massello di rifinitura TB in testa davanti l'estremità visibile dei pannelli del tetto usando le viti HS5 nella quantità di n. 3 viti ogni lato.

Bevestig de gevellijst TB onder de dakrand met behulp van de HS5 schroeven(3 stuks).

Katusekilbi otsa kinnitage räästalaud TB, kasutades kruvi HS5 (3tk.)

Screw through the upper part of the roofing using HS4 screws (8 screws per the double panel section you created) into the wall section underneath (WF). Once this is complete you can then remove the temporary supports AB and ML.

Schrauben sie nun durch die dachelemente (B-B,C-C etc.) die schrauben HS4 (8 schrauben je doppeldreieck) in die darunter liegende komponente WF um die dachflächen mit den wänden zu verbinden. Sobald dies abgeschlossen ist, können die temporären stützen ML und AB entfernt werden.

Visser les panneaux de toit en place aux madriers supérieurs de finition (WF) en utilisant les vis HS4 (8 vis par panneaux préassemblés). Une fois terminée, vous pouvez enlever les supports ML de chaque panneau et le poteau de maintien de toit AB.

Avvitare il tetto da sopra utilizzando n. 8 viti HS4 in ogni lato dell'esagono ottenuto, alla sommità delle pareti del gazebo. Terminata questa operazione potrete tranquillamente togliere gli elementi ML ed il palo di sostegno AB essendo divenuti ormai inutili.

Schroef door het bovenste gedeelte van het dak met de HS4 schroeven (8 schroeven per dubbele paneel sectie). Wanneer dit gedaan is kan de tijdelijke ondersteuning ML en AB verwijderd worden.

Kinnitage katusekilp pealt poolt seina külge (WF), kasutades kruvi HS4 (8 kruvi ühele monteeritud katusekilbile). Seejärel saate eemaldada ajutised toed AB, ML.

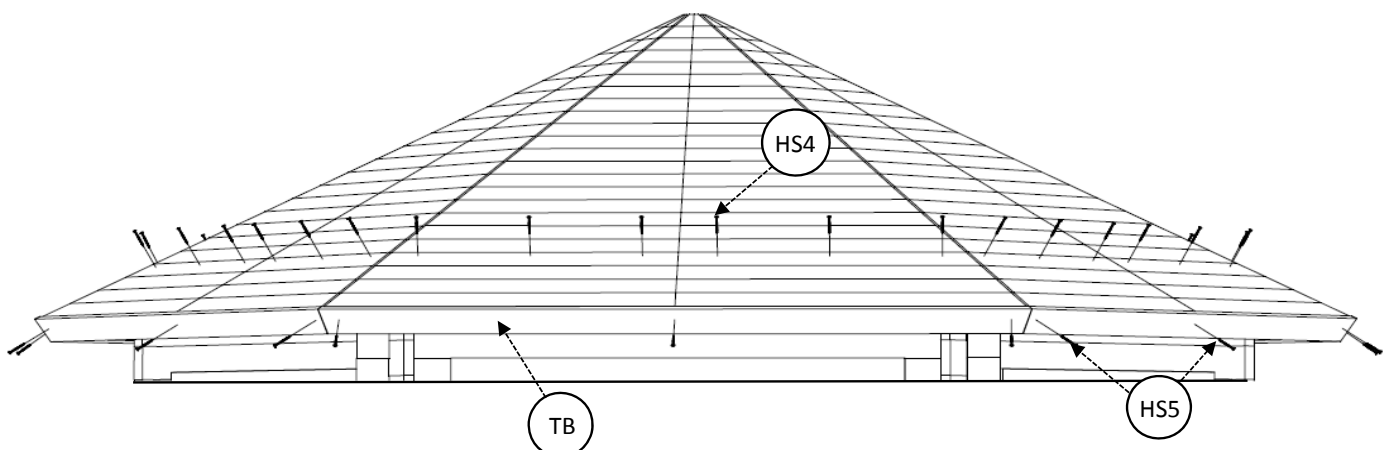

Then you are ready to apply shingles or felt(not supplied).















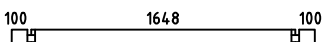
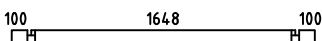
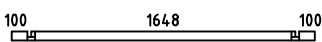
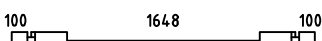
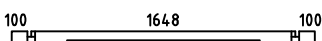
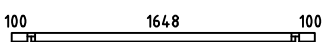



Nun können sie damit beginnen die dacheindeckung zu verlegen(nicht im lieferumfang enthalten).













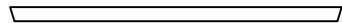

Vous pouvez maintenant procéder à la mise en place de la finition de toiture (fournie séparément en option).

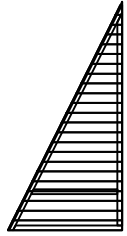
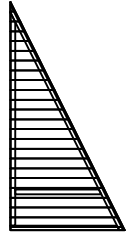
Adesso potete applicare sul tetto qualsiasi tipo di protezione e rifinitura abbiate deciso di acquistare.

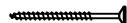
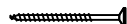

Hierna kan het asfaltpapier of de shingels gemonteerd worden.





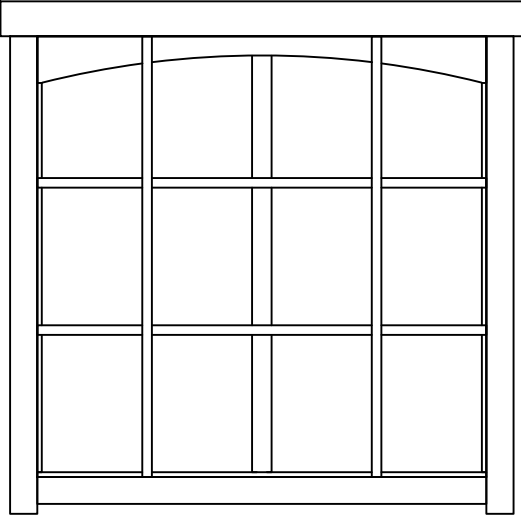
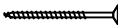

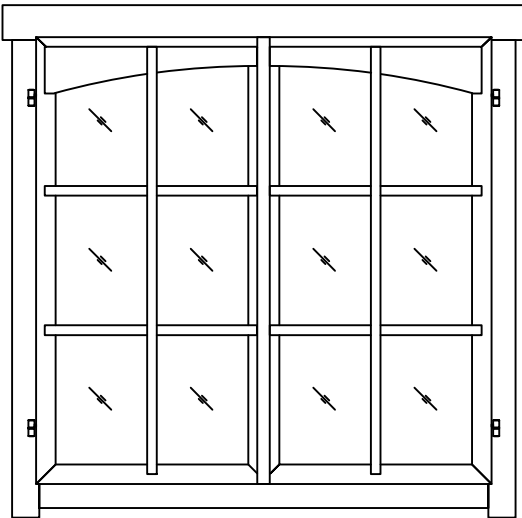
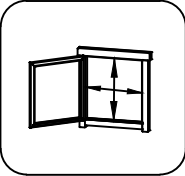
Nüüd on katus valmis katusekatte materjaliks (ei sisaldu maja tarnekomplektis).

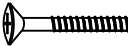
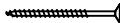
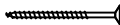
Pos	08.06.2018 Piece list - Stückliste - Liste des pièces - Elementi - Stuklijst - Tükital 16/18 Art.Nr. 442300	Q	P (mm)	L (mm)
001		1	44x57	355
002		1	44x57	355
003		69	44x114	355
004		69	44x114	355
005		32	44x114	1950
006		3	44x114	1950
007		2	44x57	1950
008		2	44x114	1950
009		2	44x114	1950
010		3	44x57	1950
IAR3	Foundation - Fundament - Fondation - Fondamenta - Fundering - Immutatud alusraam 	2	70x45	3026
IAR2	Foundation - Fundament - Fondation - Fondamenta - Fundering - Immutatud alusraam 	2	70x45	2345
IAR1	Foundation - Fundament - Fondation - Fondamenta - Fundering - Immutatud alusraam 	6	70x45	1744
WF	Lath - Pfetten - Liteau - Piccola asse - Gordingen - Roov 	6	44x57	1750
	Floor boards - Fussbodenbretter - Lamé de plancher - Pavimento - Vloerhout - Põrandalaud 	18	90x18	2939
	Floor boards - Fussbodenbretter - Lamé de plancher - Pavimento - Vloerhout - Põrandalaud 	2	90x18	2939
	Floor boards - Fussbodenbretter - Lamé de plancher - Pavimento - Vloerhout - Põrandalaud 	2	90x18	2760
	Floor boards - Fussbodenbretter - Lamé de plancher - Pavimento - Vloerhout - Põrandalaud 	2	90x18	2449
	Floor boards - Fussbodenbretter - Lamé de plancher - Pavimento - Vloerhout - Põrandalaud 	2	90x18	2137
	Floor boards - Fussbodenbretter - Lamé de plancher - Pavimento - Vloerhout - Põrandalaud 	2	90x18	1825
	Floor boards - Fussbodenbretter - Lamé de plancher - Pavimento - Vloerhout - Põrandalaud 	2	90x18	1513
	Floor boards - Fussbodenbretter - Lamé de plancher - Pavimento - Vloerhout - Põrandalaud 	2	90x18	1202
	Floor boards - Fussbodenbretter - Lamé de plancher - Pavimento - Vloerhout - Põrandalaud 	2	90x18	890

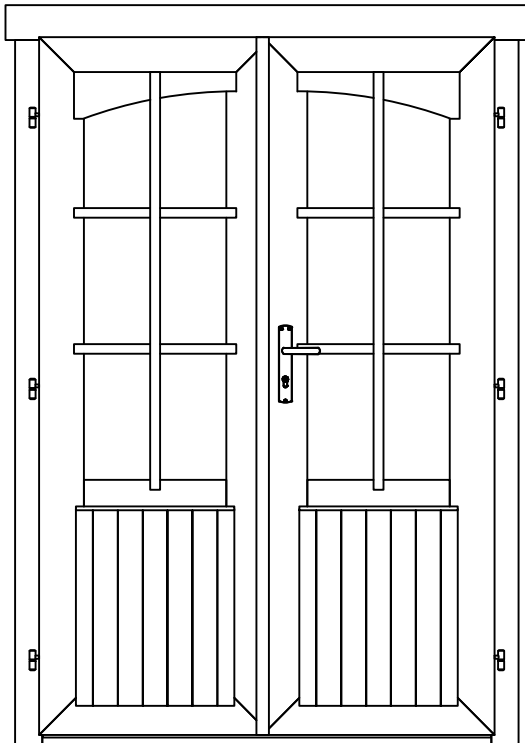
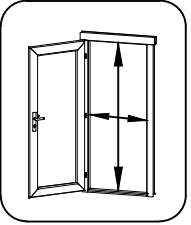
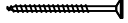
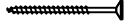
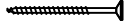
Pos	08.06.2018 Piece list - Stückliste - Liste des pièces - Elementi - Stuklijst - Tükitalabel Art.Nr. 442300 17/18	Q	P (mm)	L (mm)
	Floor boards - Fussbodenbretter - Lame de plancher - Pavimento - Vloerhout - Põrandalaud 	2	90x18	578
	Floor boards - Fussbodenbretter - Lame de plancher - Pavimento - Vloerhout - Põrandalaud 	2	90x18	266
LF	Fitting slat - Lose feder - Profil de jonction - Stecca di raccordo - Losse veer - Montaažiliist põrandaelemendile 	1	6x15	2939
TB	Fascia board - Traufbrett - Bandeau de toit - Finitura lati tetto - Gevellijst - Räästalaud 	6	18x90	2130
	Floor fillet - Fussbodenteiste - Corniere de finition du plancher - Finitura per pavimento (battisco pa) - Vloerafwerkljst - Põrandaliist 	6	18x18	1700
AB	Assembly batten - Montagelatte - Baguettes de maintien, nécessaires a la mise en place des panneaux de toit - Battente di montaggio - Montage lat - Montaažilatt 	2	28x34	1800
ML	Assembly batten - Montagelatte - Baguettes de maintien, nécessaires a la mise en place des panneaux de toit - Battente di montaggio - Montage lat - Laud katusekilpide fikseerimiseks 	12	18x90	
SH44	Hammer block - Schlagholz - Calle de frappe - Blocco di legno da usare come cuscinetto quando si usa il martello - Slagklos - Löögiklots 	1		
1	Roof element - Dachelement - Panneau de toit prémonté - Componente del tetto - Dakelement - Katusekilp 	6	62x1050	2100
2	Roof element - Dachelement - Panneau de toit prémonté - Componente del tetto - Dakelement - Katusekilp 	6	62x1050	2100
SPC	Storm protection wire cables - Drahtseile für sturmsicherung - Cables métallique anti-tempete - Cavi di protezione antivento - Storm beveiliging draadkabels - Tormikinnitustross 	3		6250
HS16	Screw for 1. wall beam - Schraube für 1. bohlenreihe - Vis de fixations 1ere rangée de madriers avec poutrelles de fondations - Vite fissaggio alle fondamenta - Schroef voor 1 wandbalk - Kruvi poollauale 	8	5x90	
HS1	Screw for fixing roof elements - Schraube für befestigung dachelementen - Vis de fixation des panneaux de toit - Vite per fissare gli elementi del tetto - Schroef voor bevestiging dakelement - Kruvi kilpide montaažiks 	144	4.5x80	
HS2	Screw for assembly batten - Schrauben für montagelatte - Vis de fixation des baguettes de maintien pour mise en place du toit - Viti per assemblaggio stecca - Schroef voor montage lat - Kruvi katusekilpide fikseerimiseks 	24	4x40	
HS5	Screw for fascia boards - Schrauben für traufbretter - Vis pour fixation bandeau de toit - Viti x striscia del tetto - Schroef voor gevellijst - Kruvi räästalauale 	18	4x40	
HS3	Screw for assembly batten - Schrauben für montagelatte - Vis de fixation des baguettes de maintien pour mise en place du toit - Viti per assemblaggio stecca - Schroef voor montage lat - Kruvi montaažilatile 	4	4x60	
HS16	Screw for foundation - Schrauben zur befestigung fundament - Vis de fixations des poutrelles de fondations - Viti x fondamenta - Schroef voor fundering - Kruvi alusraamile 	14	5x90	
HS4	Screw for fixing roof elements - Schraube für befestigung dachelementen - Vis de fixation des panneaux de toit - Vite per fissare gli elementi del tetto - Schroef voor bevestiging dakelement - Kruvi kilpide kinnitamiseks seinaga 	48	5x90	
HS16	Screw for roof lath - Schraube für dachlatte - Vis pour latte - Vite per listello del tetto - Schroef voor daklat - Kruvi roovile 	18	5x90	

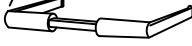
Pos	15.08.2017 Piece list - Stückliste - Liste des pièces - Elementi - Stuklijst - Tükítabel 1232x1210 TAK.1.106.TSM0.Kd SGC+A	1/1	Q	P (mm)	L (mm)
<p data-bbox="264 152 1289 185">Glass size - Glasgröße - Taille de la vitre - Misura del vetro - Glas afmeting - Klaasi mõõt: 561x1130 mm</p> 					
HS1	<p data-bbox="264 2119 1107 2197">Screw for georgian bars - Schraube für sprossen - Vis pour croisillons - Viti per unire la griglia georgiana della finestra - Schroeven voor raamverdeling - Kruvi akna petfeliistule</p>		12	2.5x20	

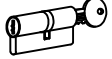
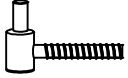
Pos	18.09.2017 Piece list - Stückliste - Liste des pièces - Elementi - Stuklijst - Tükitalabel 1232x1210 TAK.1.106.TSVP.Kd SGC+A	1/1	Q	P (mm)	L (mm)
	<p data-bbox="258 152 1284 183">Glass size - Glasgröße - Taille de la vitre - Misura del vetro - Glas afmeting - Klaasi mõõt: 512x1066 mm</p>   <p data-bbox="1364 347 1492 376">1132x1110 mm</p>				
FS	Window handle fittings - Fenstergriff - Poignee de fenetre - Maniglia c/ferramenta - Raamhendel -/grendel -/klink - Aknalink		2		
FSP	Bolt for window handle fittings - Bolzen für fenstergriff beschlag - Vis pour fixation poignee de fenetre - Bullone x apertura manuale finestra - Schroef voor raamhendel - Akna käepideme polt		4		
HS1	Screw for georgian bars - Schraube für sprossen - Vis pour croisillons - Viti per unire la griglia georgiana della finestra - Schroeven voor raamverdeling - Kruvi akna petteliistule		20	2.5x20	
HS4	Screw for window fillet - Schraube für glasteiste - Vis de filet de fenetre - Vite per assemblaggio finestra - Schroef voor glaslijst - Kruvi akna kokkuvaltšiliistule		3	3x30	

Pos	11.08.2017	Piece list - Stückliste - Liste des pièces - Elementi - Stuklijst - Tükítabel 1232x1850 TUK.2.066.TSVP.MMWKc SGC+0A	1/1	Q	P (mm)	L (mm)
		Glass size - Glasgröße - Taille de la vitre - Misura del vetro - Glas afmeting - Klaasi mõõt: 383x1041 mm				
		  <p>1132x1768 mm</p>				
HS1	Screw for georgian bars - Schraube für sprossen - Vis pour croisillons - Viti per unire la griglia georgiana della finestra - Schroeven voor raamverdeling - Kruvi ukse peffeliistule		20	2.5x20		
HS4	Screw for door fillet - Schraube zur befestigung türleiste - Vis pour fixation baguette d'arret de porte - Viti per massellino della porta - Schroef voor deurlijst - Kruvi ukse kokkuvaltssiliistule		5	3x30		
HS16	Screw for door jamb - Schraube für türrahmen - Vis de fixation partie haute avec montants du cadre de porte - Viti x fissaggio montanti porte - Schroef voor deurkozijn - Kruvi ukse lengile		4	5x90		
HS25	Screw for doorstep - Schrauben für swelle - Vis pour fixation barre de seuil - Vite per soglia della porta - Schroef voor deurdorpel - Kruvi lävepakule		3	4.5x65		
TL4	Door handle fittings - Türgriff - Poignee de porte - Maniglie - Deurhendel / klink - Ukse käepide VU		1			
TL5	Set of door lock covers - Schlossblenden - Set de garnitures de porte - Copertura serrature - Slot sluitplaat set - Ukse lukuplaat		1			
	Cylinder lock - Zylinderschloss - Barillet de porte - Serratura - Cylinder slot - Ukse lukusüdamik		1	30x35		
	Male bolt hinge for door - Türband - Partie male de paumelle de porte - Cerniera anube x porta - Scharnier bout - Ukse polthing isane		6			
	Striker for barrel bolt - Hülse für grendelriegel - Gache au sol du targette - Boccola per fermo della porta - Huls voor vergrendelingsschuif - Vasturaud ukse servariivile		2			