

Lekstuga Lido
Art.Nr. 284799
1/9



5.04.2019

Art.Nr. 284799

Groundplan - Grundplan - Plan de masse -
Planimetria - Plattegrond - Põhiplaan

Roof beam - Dachbalken - Panne de toit -
Perlina del tetto - Gordingen / dakbalk - Pärilin

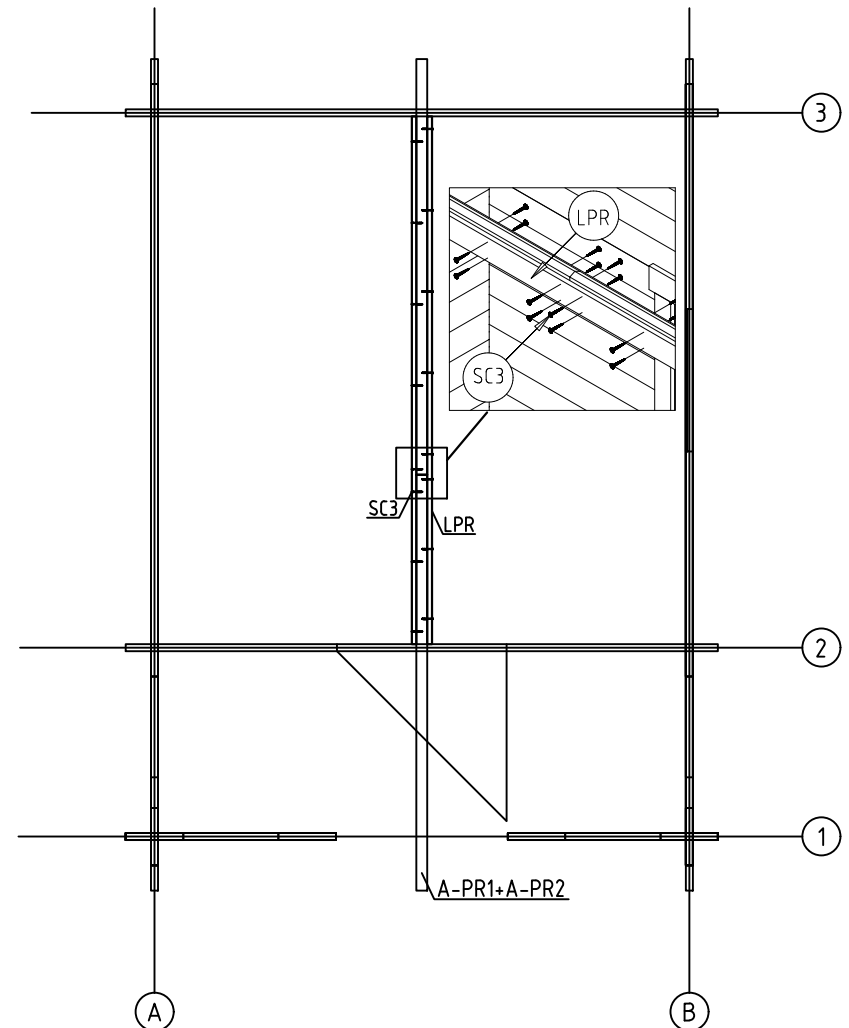
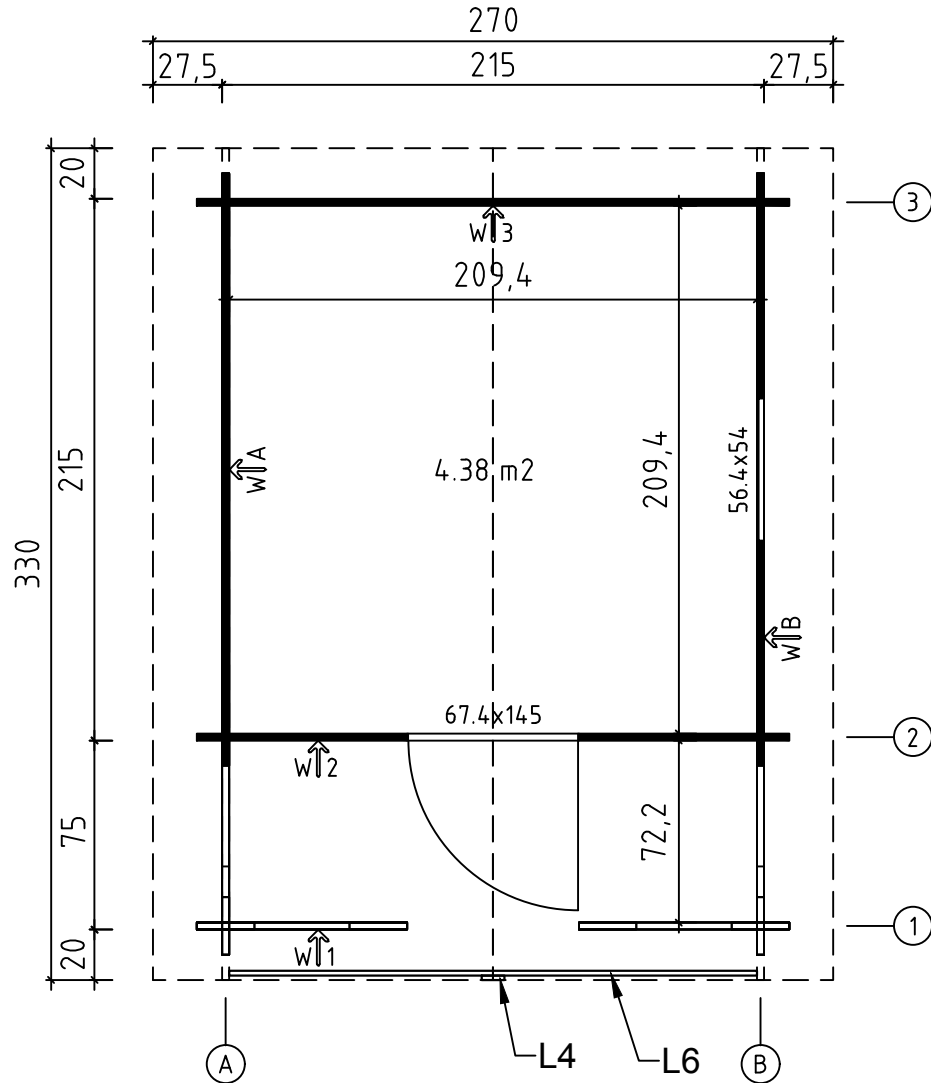

Art.Nr. 284799

Foundation - Fundament - Fondation -
Fondamenta - Fundering - Immutatud alusraam

Floor boards - Fussbodenbretter - Plan pose plancher -
Pavimento - Vloerhout - Põrandalaudis

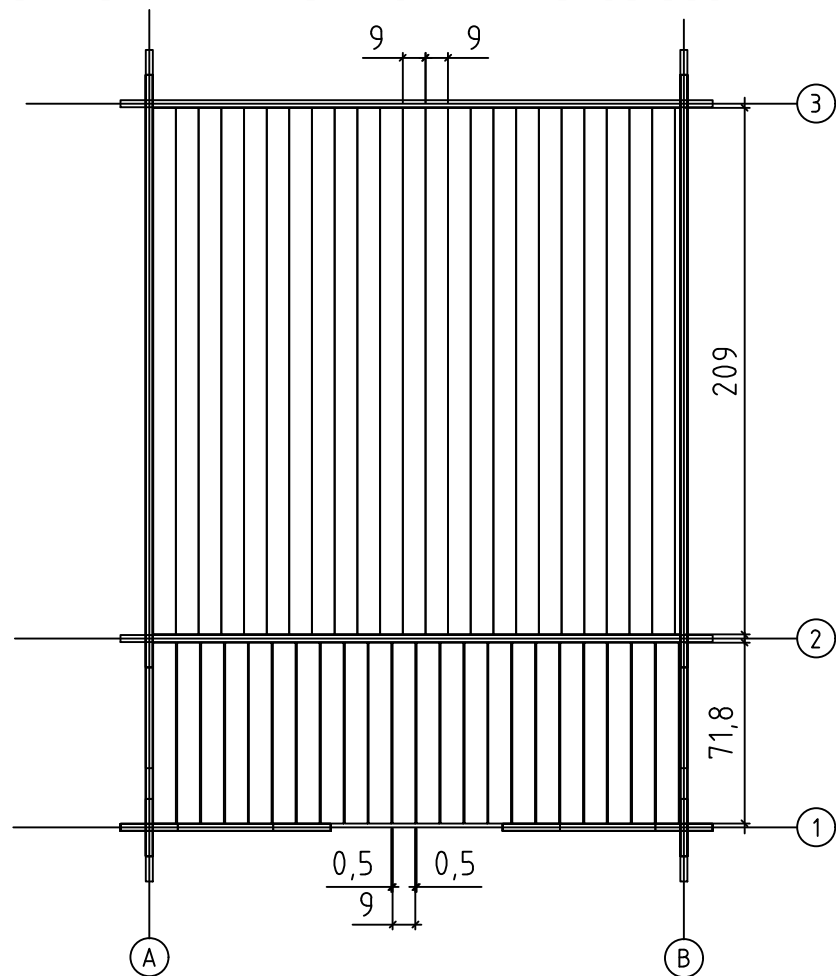
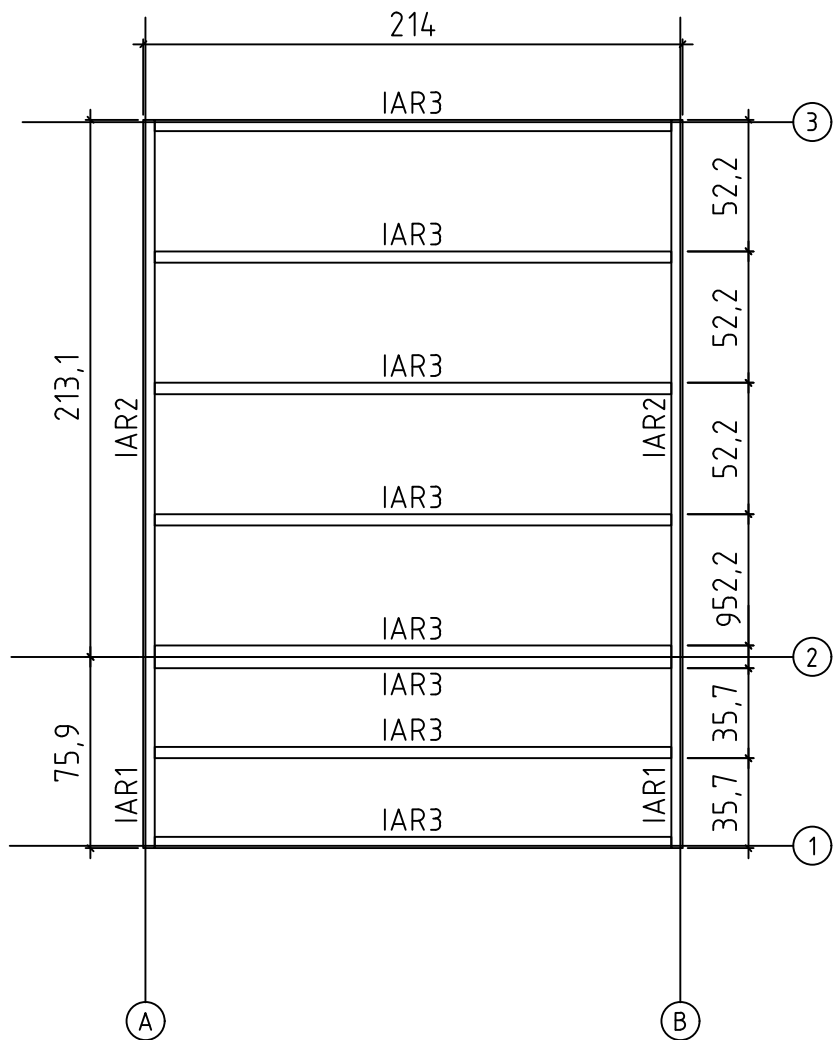





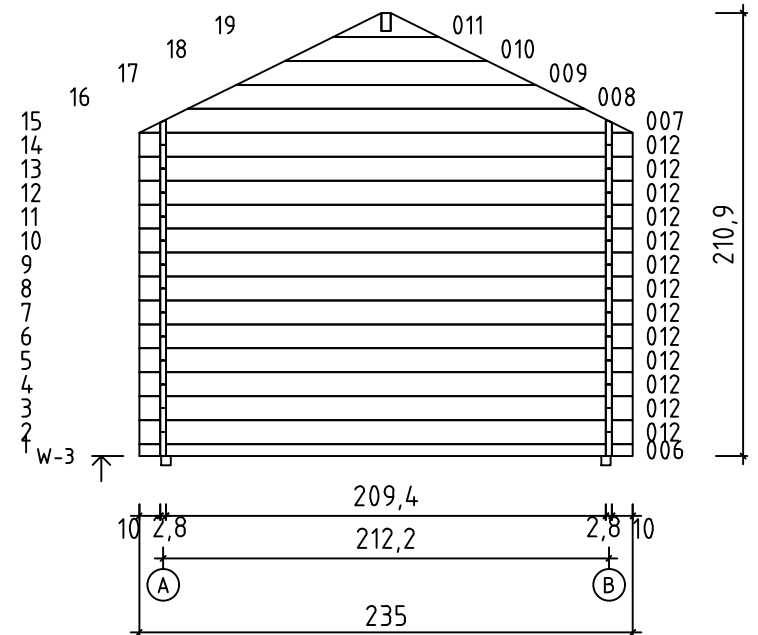
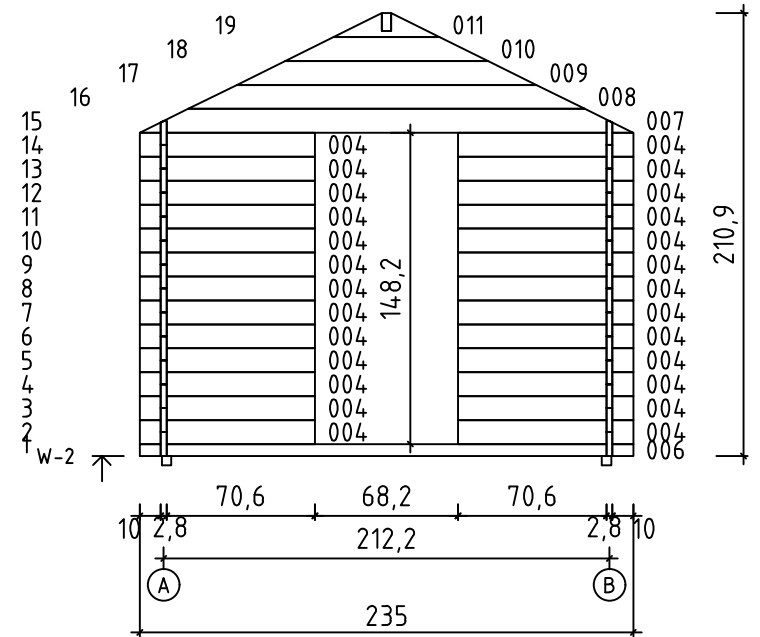
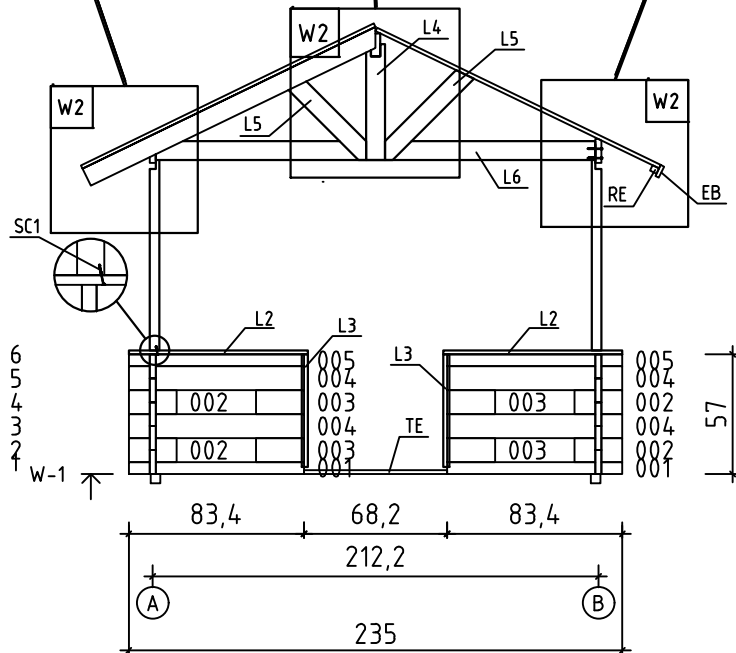
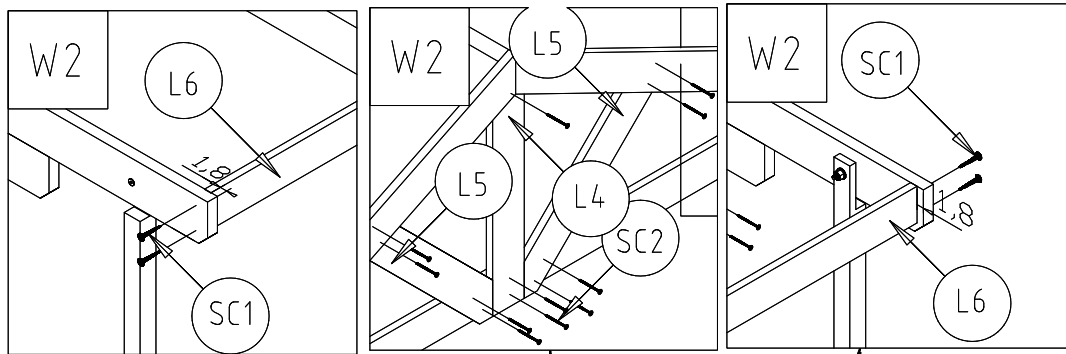

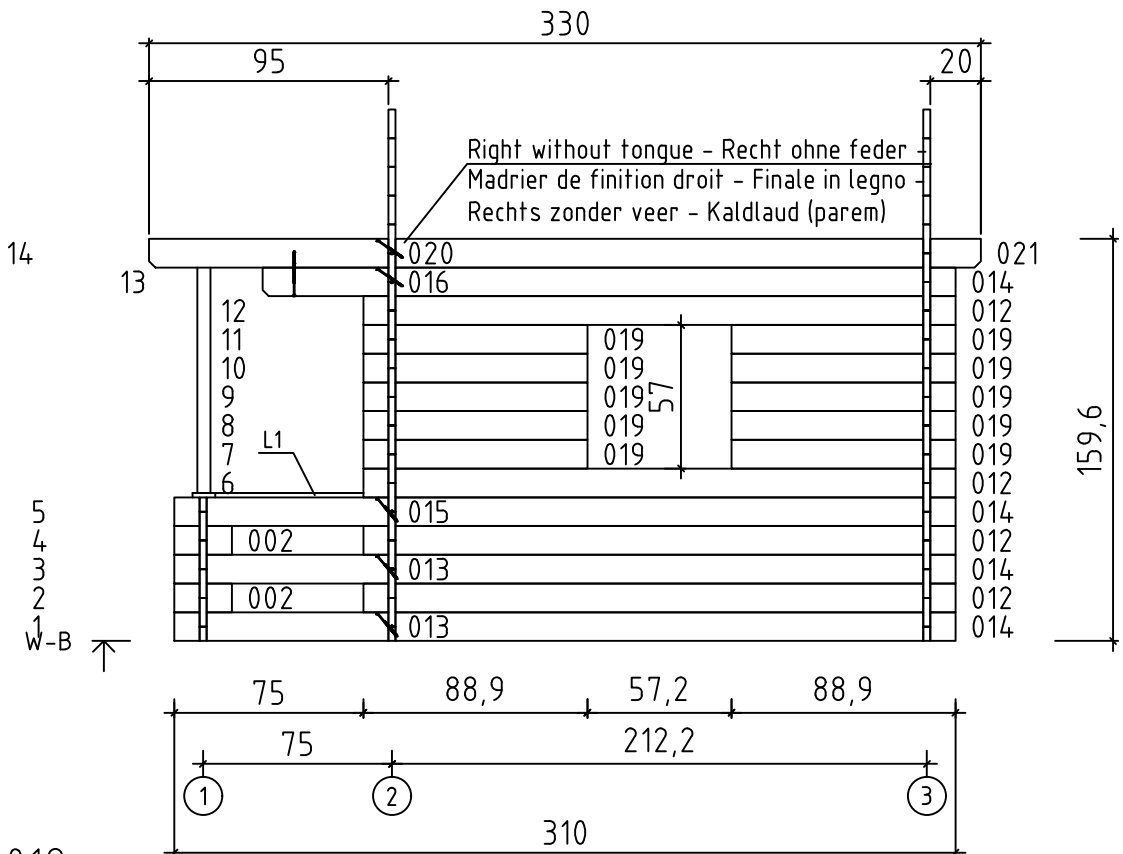
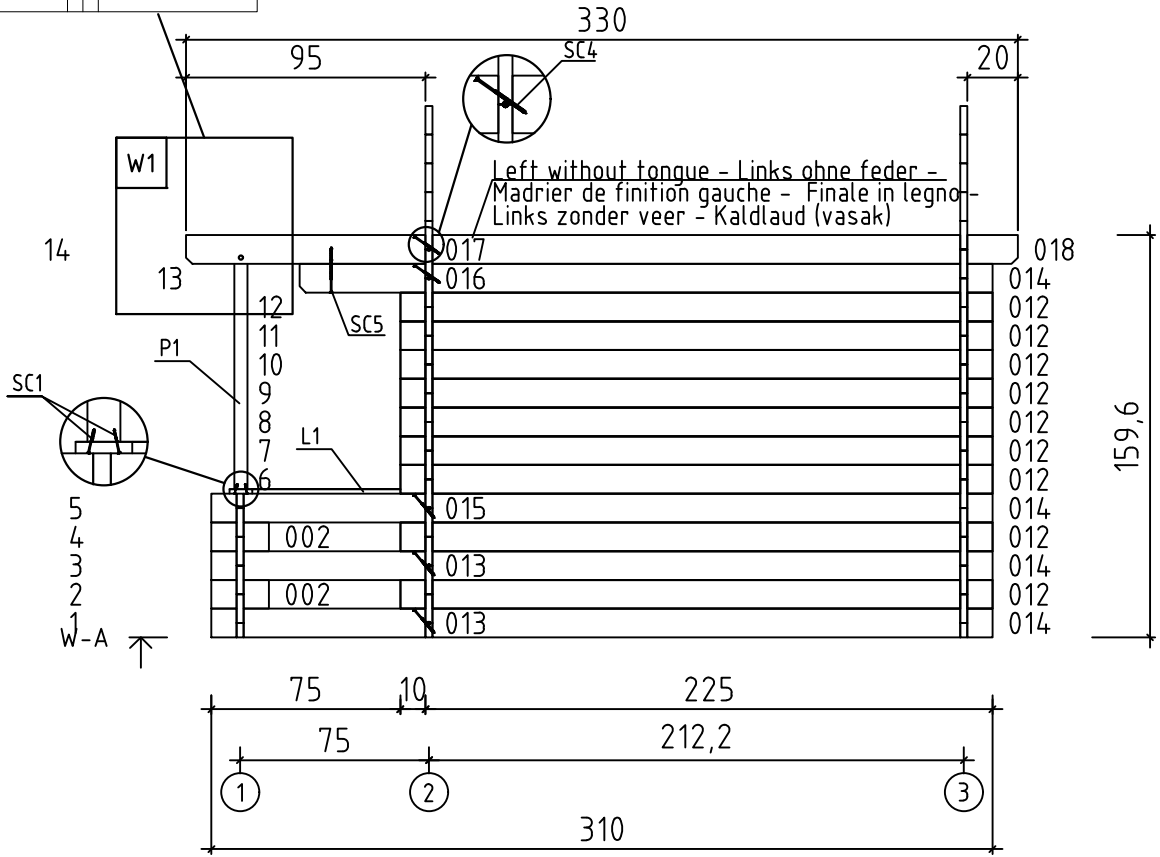
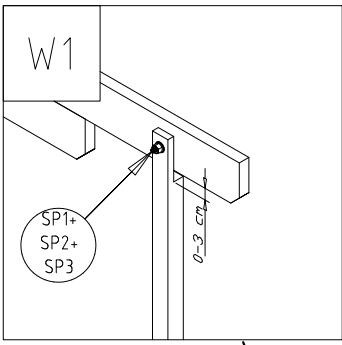

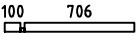

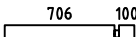
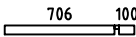
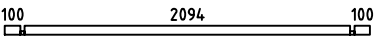
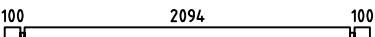
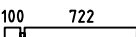
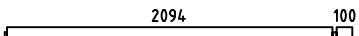
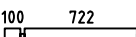

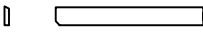
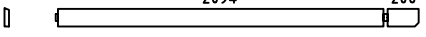
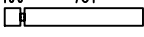
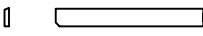
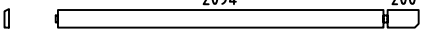
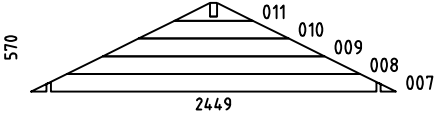
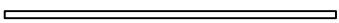
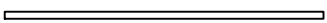
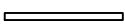
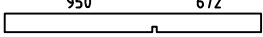
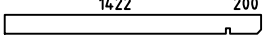

Terrace boards - Terrassenbretter - Plancher de terrasse -
Piattaforme terrazzo - Terrasvloer - Terrassilaudis



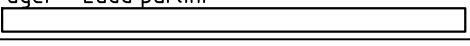





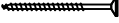
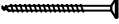
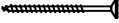
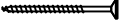
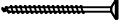
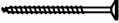
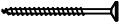
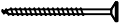
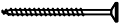
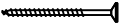
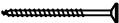
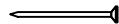

Art.Nr. 284799



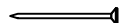



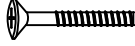



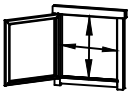
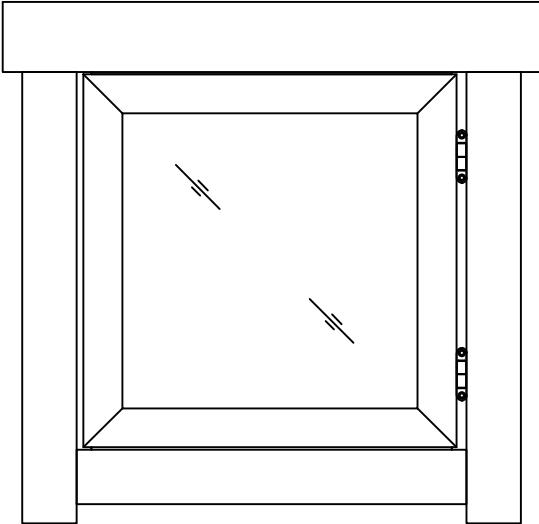
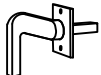
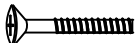

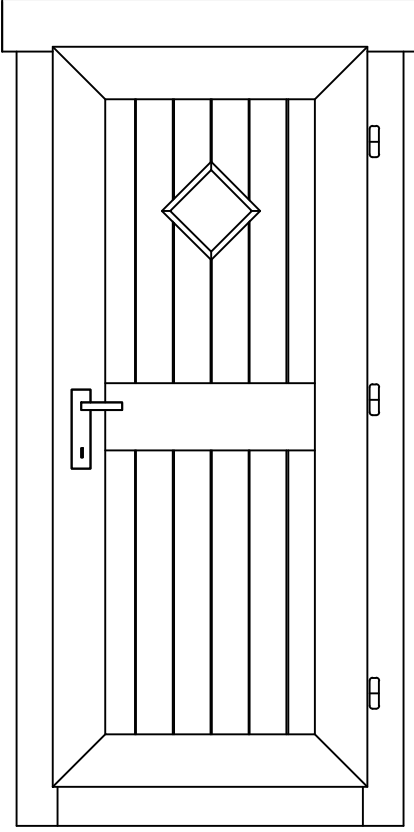
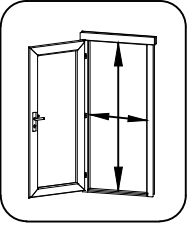
Pos	05.04.2019 Piece list - Stückliste - Liste des pièces - Elementi - Stuklijst - Tükitalabel Art.Nr. 284799 6/9	Q	P (mm)	L (mm)
001		2	28x57	834
002		8	28x114	228
003		4	28x114	228
004		30	28x114	834
005		2	28x57	834
006		2	28x57	2350
012		26	28x114	2350
013		4	28x114	864
014		8	28x114	2236
015		2	28x114	864
016		2	28x114	514
017		1	28x120	964
018		1	28x120	2336
019		10	28x114	889
020		1	28x120	964
021		1	28x120	2336
W2-1 W3-1		1 1		
IAR2	Foundation - Fundament - Fondation - Fondamenta - Fundering - Immutatud alusraam 	2	45x45	2131
IAR3	Foundation - Fundament - Fondation - Fondamenta - Fundering - Immutatud alusraam 	8	45x45	2050
IAR1	Foundation - Fundament - Fondation - Fondamenta - Fundering - Immutatud alusraam 	2	45x45	759
A-PR1	Roof beam - Dachbalken - Panne de toit - Perlina del tetto - Gordingen / dakbalk - Pärilin 	1	44x120	1650
A-PR2	Roof beam - Dachbalken - Panne de toit - Perlina del tetto - Gordingen / dakbalk - Pärilin 	1	44x120	1650

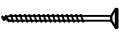
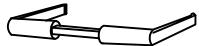
Pos	Piece list - Stückliste - Liste des pièces - Elementi - Stuklijst - Tükitalabel 05.04.2019 Art.Nr. 284799 7/9	Q	P (mm)	L (mm)
	Floor boards - Fussbodenbretter - Lame de plancher - Pavimento - Vloerhout - Põrandalaud 	24	90x18	2090
	Terrace boards - Terrassenbretter - Plancher de terrasse - Piattaforme terrazzo - Terrasvloer - Terrassilaud 	22	90x19	718
	Roof boards - Dachbretter - Voliges - Perlina per tetto - Dakhout - Katuselaud 	74	90x18	1500
	Floor fillet - Fussbodenleiste - Corniere de finition du plancher - Finitura per pavimento (battisco pa) - Vloerafwerklijst - Põrandaliist 		18x18	8.36
	Roofing felt fillet - Dachpappeleiste - Baguette de fixation du feutre bitumeux - Asse per fissaggio guaina bituminosa - Afdekljst asfaltpapier - Katusepapiliist 	4	18x58	1550
L4	Roof support - Dach träger - Support de toit - Supporto del tetto - Dak ondersteuning - Katusetugi 	1	18x90	552
L5	Roof support - Dach träger - Support de toit - Supporto del tetto - Dak ondersteuning - Katusetugi 	2	18x90	574
L6	Roof support - Dach träger - Support de toit - Supporto del tetto - Dak ondersteuning - Katusetugi 	1	18x90	2094
LPR	Roof beam support - Dachbalken träger - Support panne de toit - Supporto della perlina del tetto - Gording schoen / balkdrager - Laud pärlini fikseerimiseks 	2	18x90	2094
EB	Fascia board - Traufbrett - Bandeau de toit - Finitura lati tetto - Gevellijst - Räästalaud 	4	18x58	1650
RE	Roof edge reinforcement - Dachrandverstärkung - Corniere de renfort de bord de toit - Rinforzo x tetto - Dakrand versterking - Räästatugevdus 	4	28x34	1650
TE	Terrace edge board - Terrassenbrett, eingang - Lame de seuil d'entree de terrasse - Terrazzo uso abitacolo - Terrasvloer dorpel - Terrassi servaliist 	1	19x28	680
P1	Post - Pfosten - Poteau - Piede registrabile - Stijl - Post 	2	44x44	980
L1	Guard-rail for terrace - Terrassengeländer - Main courante de terrasse - Guardrail per terrazzo - Terras leuning - Terrassi äärelaud 	2	18x90	588
L2	Guard-rail for terrace - Terrassengeländer - Main courante de terrasse - Guardrail per terrazzo - Terras leuning - Terrassi äärelaud 	2	18x90	853
KFS-1	Storm protection - Sturmleiste - Latte anti-tempete - Protezione anti vento - Stormverankering / beveiliging - Tormikinnitusliist 	4	22x45	2050
L3	U-profile - U-profils - Profile u - Profilo ad u - U-profiel - U-profiil 	2	28x58	537
GL	Gable moulding - Giebelleiste - Planche de rive - Finitura per frontale e retro del tetto - Gevellijst - Viilulaud 	4	18x90	1550
HS8	Screw for gable segment - Schrauben für deckblatt - Vis pour fixation losange de finition - Viti x frontali tetto - Schroef voor gevelpunt segment - Kruvi rombile 	4	3.5x35	
HS9	Screw for gable moulding - Schrauben für giebelleiste - Vis pour fixation planche de rive - Vite per fissare finiture davanti e dietro del tetto - Schroef voor gevellijst - Kruvi viilulauale 	16	3.5x50	
SC2	Screw for post - Schrauben für pfosten - Vis de fixation des poteaux - Viti per inviare - Schroef voor stijlen - Kruvi postile 	12	3x35	
HS14	Screw for u-profile - Schraube zur befestigung u-profils - Vis a tete fraisée pour profil u - Vite per profilo ad u - Schroef ter bevestiging u-profiel - Kruvi U-profiilile 	4	4.5x80	
SC3	Screw for fixing roof beam support - Schraube zur befestigung dachbalken träger - Vis de fixation support panne de toit - Vite per il fissaggio della trave di supporto del tetto - Schroef voor bevestiging gording dräger - Kruvi pärlini fikseerimislauale 	32	4x40	

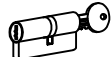
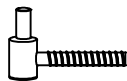
Pos	Piece list - Stückliste - Liste des pièces - Elementi - Stuklijst - Tükítabel 05.04.2019 Art.Nr. 284799 8/9	Q	P (mm)	L (mm)
HS12	Screw for fascia boards - Schrauben für traufbretter - Vis pour fixation bandeau de toit - Viti x striscia del tetto - Schroef voor gevellijst - Kruvi räästalaualae 	16	4x40	
HS12	Screw for roof edge reinforcement - Schrauben für dachrandverstärkung - Vis pour fixation corniere renfort de bord de toit - Viti x rinforzo bordo tetto - Schroef voor dakrand versterking - Kruvi räästatugevdusele 	16	4x40	
HS12	Screws for terrace edge board - Schrauben für terrassenbrett - Vis de fixation de lame de seuil d'entree de terrasse - Vite per unire delle assi del terrazzo - Schroeven voor terrashout - Kruvi terrassi servaliistule 	3	4x40	
HS12	Screw for terrace rear boards - Schrauben für terrassenrand - Vis de fixation pour main courante de terrasse - Vite per il piano posteriore della terrazza - Schroef voor terras afsluitplint (achterzijde) - Kruvi terrassi äärelaualae 	10	4x40	
SC1	Screw for post - Schrauben für pfosten - Vis de fixation des poteaux - Viti per inviare - Schroef voor stijlen - Kruvi postile 	12	4x60	
HS18	Screw for roof beams - Schrauben für dachbalken - Vis pour fixation pannes de toit - Viti per perline del tetto - Schroef voor gordingen / dakbalken - Kruvi pärlinitete 	6	5x120	
SC4	Screw for wall details - Schraube für wand details - Vis pour mur details - Viti per elementi della porta - Schroef voor wand details - Kruvi seinadetailite 	10	5x120	
HS16	Screw for 1. wall beam - Schraube für 1. bohlenreihe - Vis de fixations 1ere rangée de madriers avec poutrelles de fondations - Vite fissaggio alle fondamenta - Schroef voor 1 wandbalk - Kruvi poollauale 	8	5x90	
HS16	Screw for foundation - Schrauben zur befestigung fundament - Vis de fixations des poutrelles de fondations - Viti x fondamenta - Schroef voor fundering - Kruvi alusraamile 	16	5x90	
HS16	Screw for foundation - Schrauben zur befestigung fundament - Vis de fixations des poutrelles de fondations - Viti x fondamenta - Schroef voor fundering - Kruvi alusraamile 	2	5x90	
SC5	Screw for wall details - Schraube für wand details - Vis pour mur details - Viti per elementi della porta - Schroef voor wand details - Kruvi seinadetailidele 	2	6x180	
NF2	Zn nail for floor fillet - Zn nagel für fussbodenleiste - Pointe pour corniere de finition du plancher - Chiodi x fissaggio pavimento - Spijker(nagel) voor vloer afdeklijst - Nael põrandaliistule 	17	1.4x40	
SP3	Washer for storm protection - Dichtscheibe für sturmleiste - Rondelle pour latte anti-tempete - Rondella x asta protezione vento - Afdichtring voor storm strip - Seib tormikinnitusliistule 	10	D6	
	Hammer block - Schlagholz - Calle de frappe - Blocco di legno da usare come cuscinetto quando si usa il martello - Slagklos - Löögiklots 	1		
SP1	Nut for storm protection - Schraubenmutter für sturmleiste - Ecrou pour latte anti-tempete - Dado x asta protezione vento - Moer voor stromverankering - Mutter tormikinnitusliistule 	10	D6	
NF3	Zn nail for terrace - Zn nagel für terrassenbretter - Pointe pour plancher de terrasse - Chiodo zincato per terrazza - Spijker(nagel) voor terrasvloer - Nael terrassilaualae 	132	2.1x50	
NF4	Zn nail for roof - Zn nagel für dachbretter - Pointe pour fixation voliges de toit - Chiodi x perline tetto - Spijker(nagel) voor dakhout - Nael katuselauale 	156	2x50	
NF4	Zn nail for floor - Zn nagel für fussbodenbretter - Clous pour plancher - Chiodi x perline pavimento - Spijker(nagel) voor vloer - Nael põrandalaualae 	125	2x50	
NF5	Zn nail for roofing felt fillet - Zn nagel für dachpappenleiste - Pointe pour baguette de fixation feutre bitumeux - Chiodi x carta bituminosa x tetto - Spijker(nagel) voor asfaltpapier afdeklijst - Papiiistunael 	16	2x40	
SP2	Bolt for storm protection - Bolzen für sturmleiste - Boulon pour latte anti-tempete - Bullone x asta protezione vento - Bout voor stormankerlat - Puidupolt tormikinnitusliistule 	10	6x60	
GS	Gable segment - Deckblatt - Losange de finition - Decorazione in legno x frontale tetto - Gevelpunt segment - Romb 	2		
	Window - Fenster - Fenetre - Finestra - Raam - Aken 564x540 AK.1.100.TSVP.I SGC	1		
	Door - Tür - Porte - Porte - Deur - Uks 674x1450 UK.2.020.TSVP.b SGC	1		

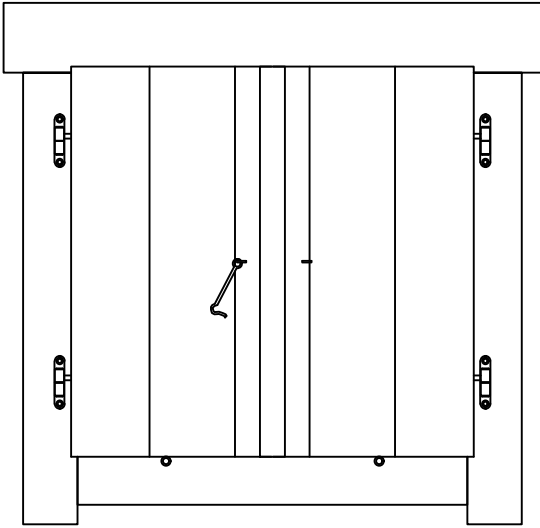
Pos	05.04.2019 Piece list - Stückliste - Liste des pièces - Elementi - Stuklijst - Tükítabel 564x540 AK.1.100.TSVP.l SGC	1/1	Q	P (mm)	L (mm)
	<p data-bbox="260 152 1284 185">Glass size - Glasgröße - Taille de la vitre - Misura del vetro - Glas afmeting - Klaasi mõõt: 396x396 mm</p> <div data-bbox="1337 152 1522 327" style="border: 1px solid black; border-radius: 10px; padding: 5px; display: inline-block;">  </div> <p data-bbox="1369 349 1490 376" style="text-align: center;">464x464 mm</p> <div data-bbox="625 434 1166 956" style="text-align: center;">  </div>				
FS	<p data-bbox="260 2040 1023 2096">Window handle fittings - Fenstergriff - Poignee de fenetre - Maniglia c/ferramenta - Raamhendel -/grendel -/klink - Aknalink</p>		1		
FSP	<p data-bbox="260 2119 1102 2197">Bolt for window handle fittings - Bolzen für fenstergriff beschlag - Vis pour fixation poignee de fenetre - Bullone x apertura manuale finestra - Schroef voor raamhendel - Akna käepideme polt</p>		2		

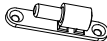
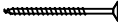
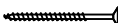
Pos	05.04.2019 Piece list - Stückliste - Liste des pièces - Elementi - Stuklijst - Tükítabel 674x1450 UK.2.020.TSVP.b. SGC	1/1	Q	P (mm)	L (mm)
	<p>Glass size - Glasgröße - Taille de la vitre - Misura del vetro - Glas afmeting - Klaasi mõõt: 160x160 mm</p>   <p>574x1350 mm</p>				
HS16	Screw for door jamb - Schraube für Türrahmen - Vis de fixation partie haute avec montants du cadre de porte - Viti x fissaggio montanti porte - Schroef voor deurkozijn - Kruvi ukse lengile		4	5x90	
HS25	Screw for doorstep - Schrauben für swelle - Vis pour fixation barre de seuil - Vite per soglia della porta - Schroef voor deurdorpel - Kruvi lävepakule		2	5x90	
TL4	Door handle fittings - Türgriff - Poignée de porte - Maniglie - Deurhendel / klink - Ukse käepide VU		1		
TL5	Set of door lock covers - Schlossblenden - Set de garnitures de porte - Copertura serrature - Slot sluitplaat set - Ukse lukuplaat		1		
	Cylinder lock - Zylinderschloss - Barillet de porte - Serratura - Cylinder slot - Ukse lukusüdamik		1	30x35	
	Male bolt hinge for door - Türband - Partie male de paumelle de porte - Cerniera anube x porta - Scharnier bout - Ukse polthing isane		3		

Pos	Piece list - Stückliste - Liste des pièces - Elementi - Stuklijst - Tükitabel 15.11.2012 Art.Nr. 995100	1/1	Q	P (mm)	L (mm)
	Shutters 564x540- Fensterläden 564x540 - Volets de fenetre 564x540 - Alconi o persiane 564x540 - Luiken 564x540 - Aknaluuk 564x540				
					
1	Hinge for shutters - Scharnier für fensterläden - Charniere pour volets - Cerniere per balconi - Raamluik scharnier - Akna polthing emane		4	D13x68	
2	Hinge for shutters - Scharnier für fensterläden - Charniere pour volets - Cerniere per balconi - Raamluik scharnier - Akna polthing isane		4	D13x68	
3	Screw for shutter hinge - Schraube für fensterläden scharnier - Vis pour shutter charniere - Viti per cerniera a battente - Schroef voor luiken scharnier - Kruvi akna polthinge		8	4x40	
4	Screw for shutters fillet - Schraube zur befestigung fensterlädenleiste - Vis d'assemblage du cadre de volets de fenetre - Viti per massellino dei balconi - Schroef voor bevestiging lijstwerk luiken - Kruvi luugi kokkuvaltšiliistule		2	3x30	
5	Shutter hook - Feststeller fensterläden - Arrets de vents pour volets - Gancio dell'otturatore - Luiken vergrendeling - Luugihaak		3	60	
6	Connection strip - Deckleiste - Baguette de battement - Profilo verticale della porta - Stulplijst - Kokkuvaltšiliist		1	13x32	502

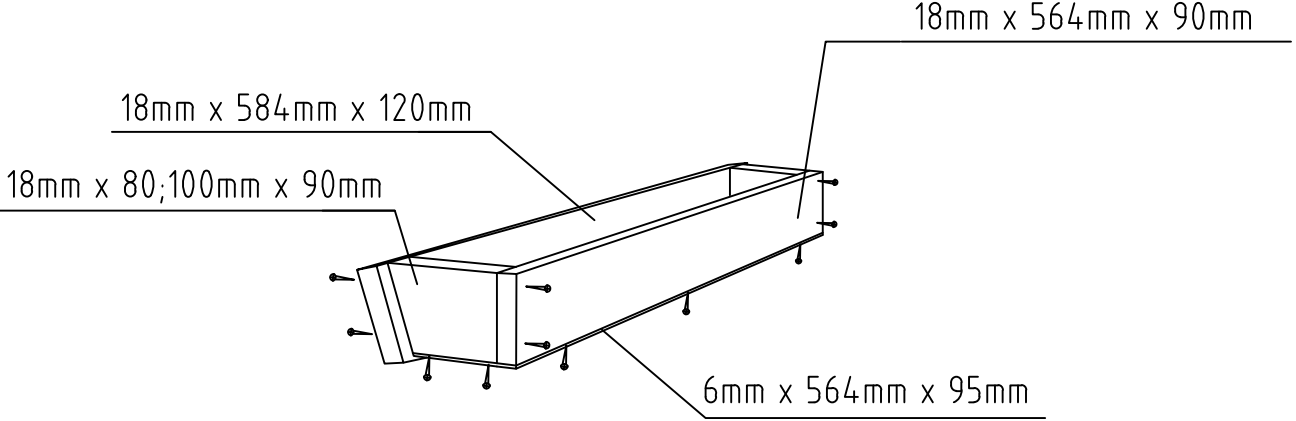
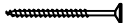
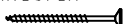
Pos	06.05.2013 Piece list - Stückliste - Liste des pièces - Elementi - Stuklijst - Tükítabel Art.Nr. 991200	1/1	Q	P (mm)	L (mm)
	<p data-bbox="268 125 1066 159">Flower box - Blumenkasten - Jardiniere - Fioriera - Bloembak - Lillekast</p> 				
HS9	<p data-bbox="260 2040 943 2114">Screw for flower box - Montagschraube für blumentasten - Vis d'assemblage des jardinières - Viti per fioriera - Montageschroeven voor bloembak - Kruvi lillekasti montaažiks</p>		18	3.5x50	
HS12	<p data-bbox="260 2125 1238 2197">Screw for fixing flower box to the walls - Schraube zur Befestigung den Blumenkasten - Vis de fixation au mur des jardinières - Viti per fissare la fioriera alle pareti - Schroeven voor bevestiging bloembak met wand - Kruvi lillekasti kinnitamiseks seinale</p>		2	4x40	