

Sundborn
Art. Nr. 4428402
1/10

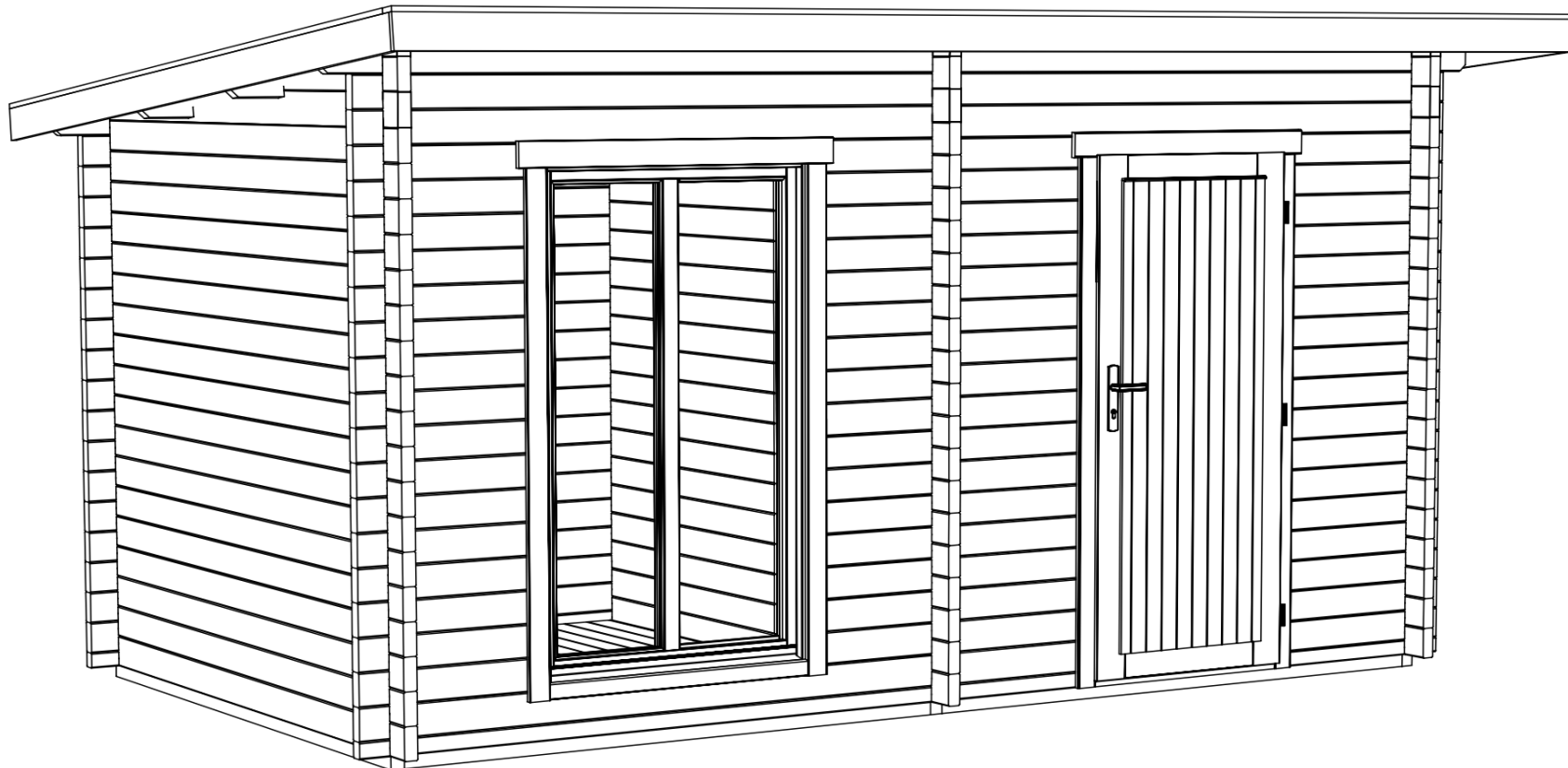

24.05.2022

Foundation - Fundament - Fondation -
Fondamenta - Fundering - Immutatud alusraam

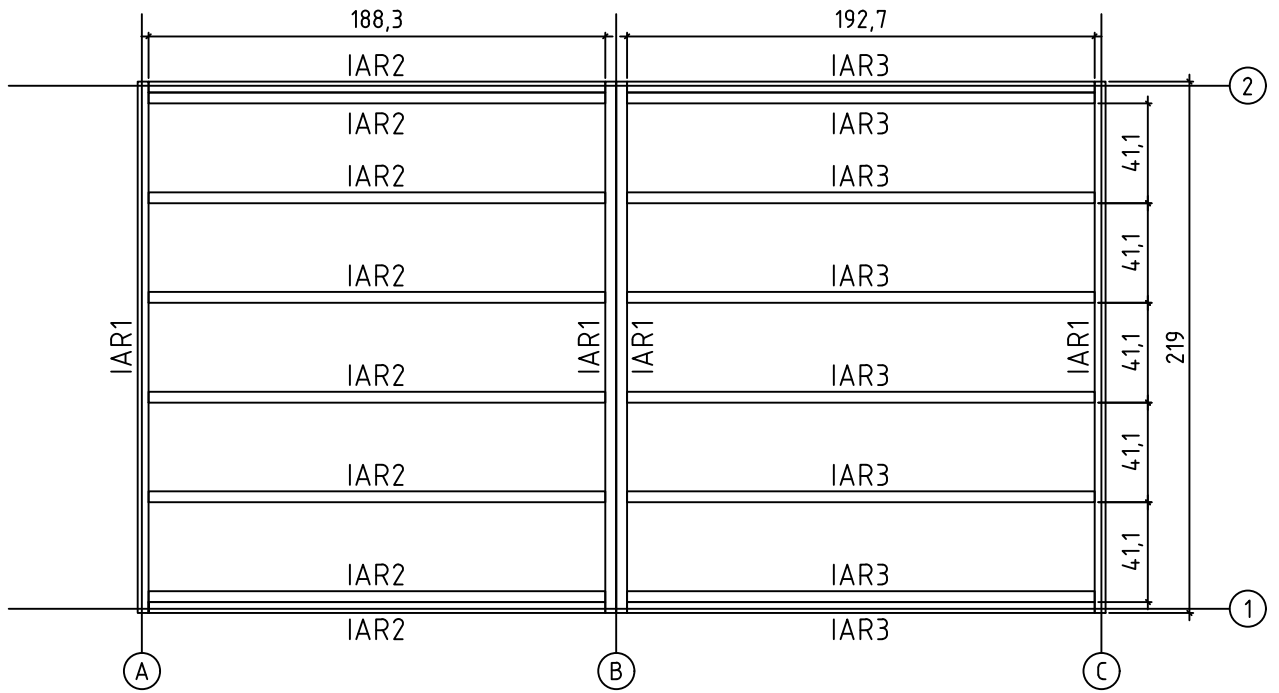

Floor boards - Fussbodenbretter - Plan pose
plancher - Pavimento - Vloerhout - Põrandalaudis

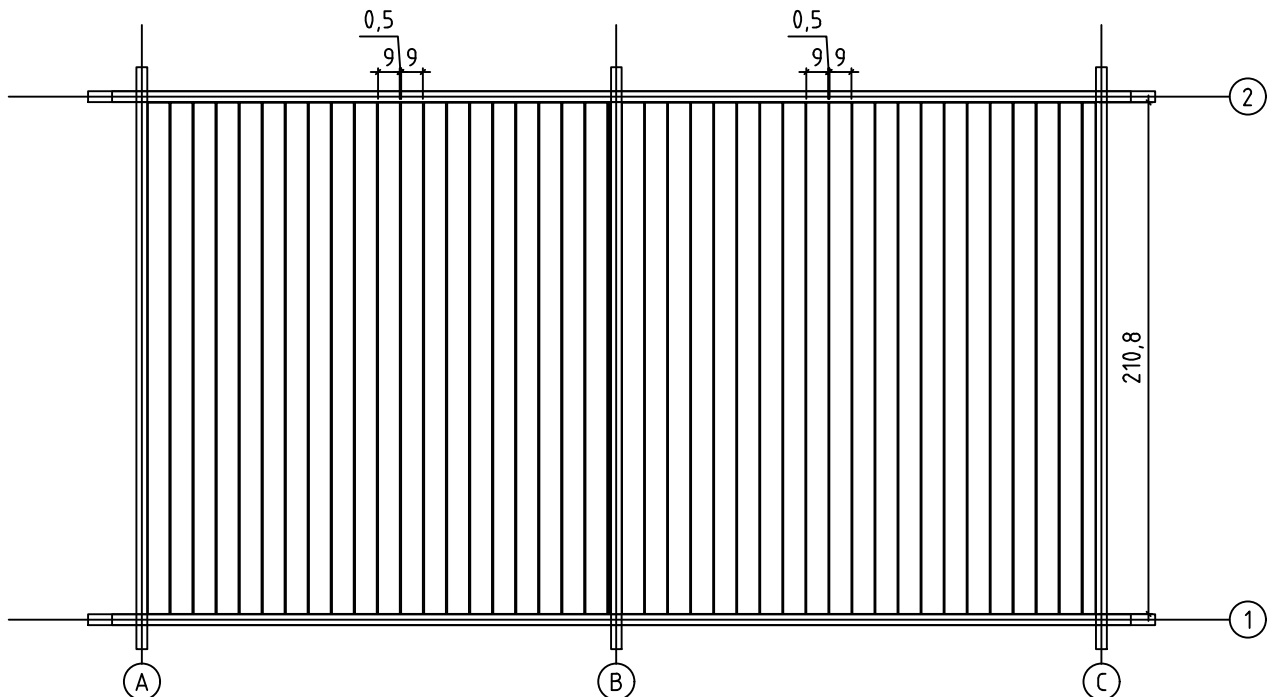



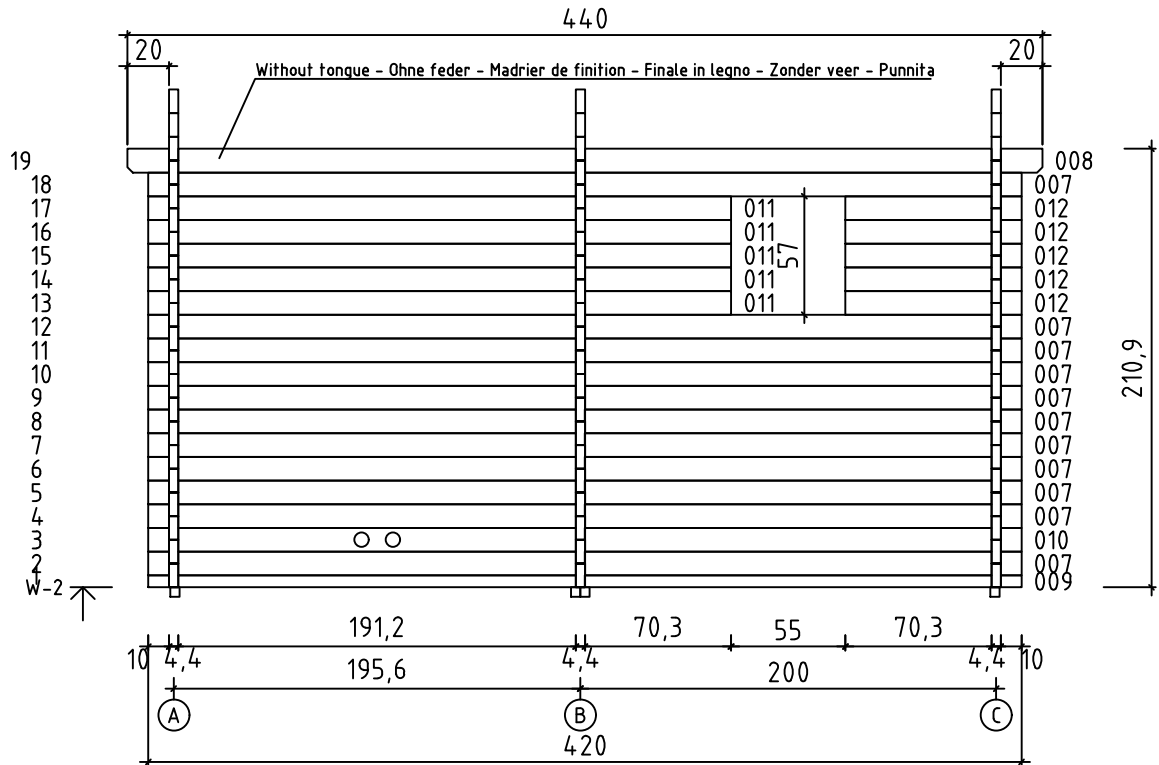
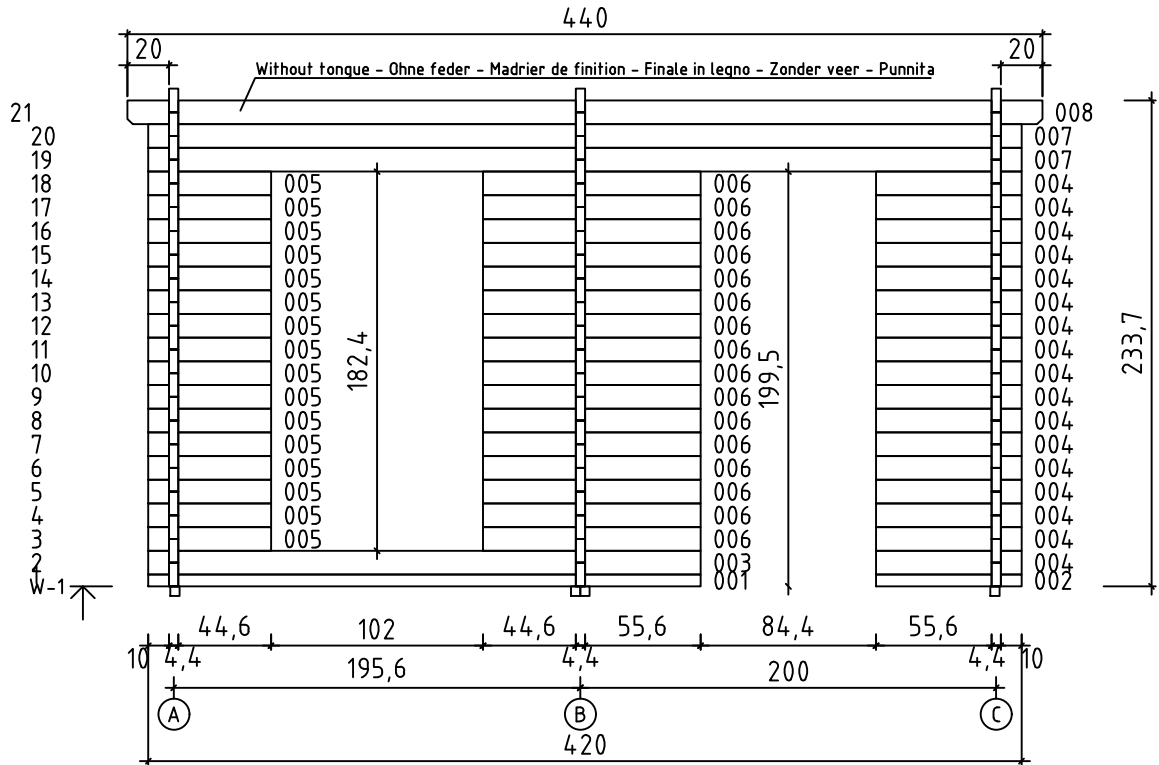



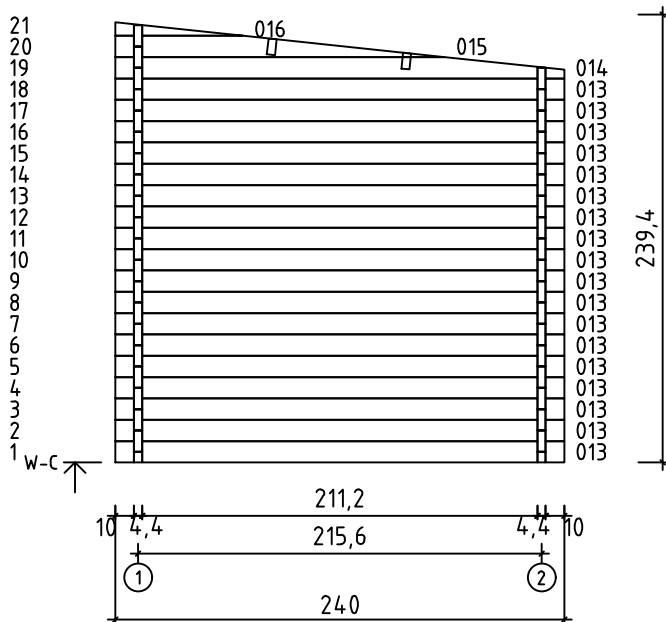
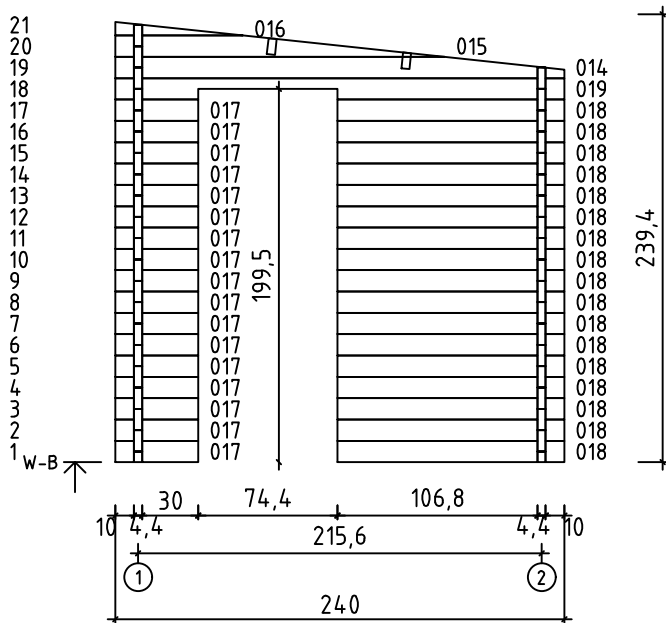
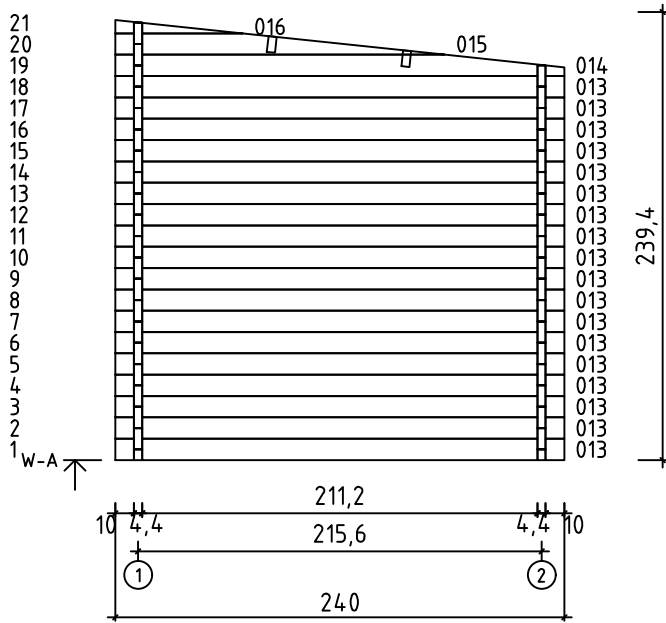

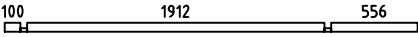
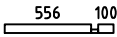
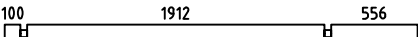
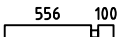

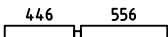
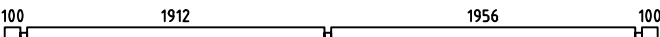
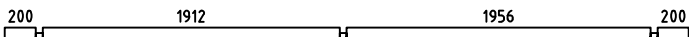
Art. Nr. 4428402

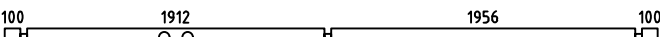
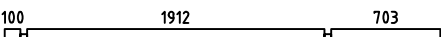
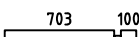
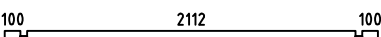

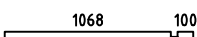
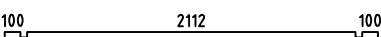
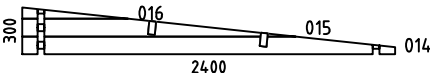

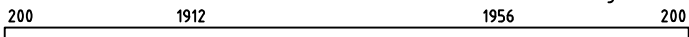
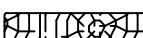

Art. №. 4428402

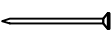
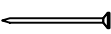
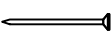
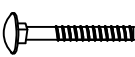

Pos	24.05.2022 Piece list - Stückliste - Liste des pièces - Elementi - Stuklijst - Tükitalabel Art. Nr. 4428402 6/10	Q	P (mm)	L (mm)
001		1	44x57	2656
002		1	44x57	700
003		1	44x114	2656
004		17	44x114	700
005		16	44x114	590
006		16	44x114	1046
007		13	44x114	4200
008		2	44x114	4400
009		1	44x57	4200
010		1	44x114	4200
011		5	44x114	2803
012		5	44x114	847
013		36	44x114	2400
017		17	44x114	444
018		17	44x114	1212
019		1	44x114	2400
WA-1 WB-1 WC-1		1 1 1		
IAR1	Foundation - Fundament - Fondation - Fondamenta - Fundering - Immutatud alusraam 	4	45x45	2190
IAR3	Foundation - Fundament - Fondation - Fondamenta - Fundering - Immutatud alusraam 	8	45x45	1927
IAR2	Foundation - Fundament - Fondation - Fondamenta - Fundering - Immutatud alusraam 	8	45x45	1883
A-PR1	Roof beam - Dachbalken - Panne de toit - Perlina del tetto - Gordingen / dakbalk - Pärlin 	2	44x120	4400
	Floor boards - Fussbodenbretter - Lame de plancher - Pavimento - Vloerhout - Põrandalaud 	42	90x19	2108

Pos	24.05.2022 Piece list - Stückliste - Liste des pièces - Elementi - Stuklijst - Tükítabel Art. Nr. 4428402 7/10	Q	P (mm)	L (mm)
	Roof boards - Dachbretter - Voliges - Perlina per tetto - Dakhout - Katuselaud 	49	90x18	3000
	Roofing felt fillet - Dachpappenleiste - Baguette de fixation du feutre bitumeux - Asse per fissaggio guaina bituminosa - Afdeklijst asfaltpapier - Katusepapiiist 	2	18x58	3010
	Roofing felt fillet - Dachpappenleiste - Baguette de fixation du feutre bitumeux - Asse per fissaggio guaina bituminosa - Afdeklijst asfaltpapier - Katusepapiiist 	1	18x58	4436
RS1	Corner fillet - Deckleiste - Profils de finition angles a l'exterieur - Massello d'angolo - (hoek)lijst - Nurgaliist 	2	15x45	200
RS2	Corner fillet - Deckleiste - Profils de finition angles a l'exterieur - Massello d'angolo - (hoek)lijst - Nurgaliist 	2	15x45	350
RS3	Corner fillet - Deckleiste - Profils de finition angles a l'exterieur - Massello d'angolo - (hoek)lijst - Nurgaliist 	2	18x90	350
DL1	Railing strip - Begrenzungsleiste - Rembarde - Sbarra - Afscheidingslijst - Piirdelaud 	2	18x90	920
DL2	Railing strip - Begrenzungsleiste - Rembarde - Sbarra - Afscheidingslijst - Piirdelaud 	4	18x90	1910
	Fascia board - Traufbrett - Bandeau de toit - Finitura lati tetto - Gevellijst - Räästalaud 	2	18x120	3050
	Fascia board - Traufbrett - Bandeau de toit - Finitura lati tetto - Gevellijst - Räästalaud 	1	18x120	4436
TB-1	Fascia board - Traufbrett - Bandeau de toit - Finitura lati tetto - Gevellijst - Räästalaud 	1	18x58	4400
DRV-1	Roof edge reinforcement - Dachrandverstärkung - Corniere de renfort de bord de toit - Rinforzo x tetto - Dakrand versterking - Räästatugevdus 	2	28x34	4400
KFS-1	Storm protection - Sturmleiste - Latte anti-tempete - Protezione anti vento - Stormverankering / beveiliging - Tormikinnitusliist 	6	22x45	2050
FF1	Fixing fillet - Fixierungsleiste - Profil de fixation - Massello di fissaggio - Bevestiging lijstwerk - Tenderliist 	1	22x45	734
FF2	Fixing fillet - Fixierungsleiste - Profil de fixation - Massello di fissaggio - Bevestiging lijstwerk - Tenderliist 	2	22x45	1910
FF3	Fixing fillet - Fixierungsleiste - Profil de fixation - Massello di fissaggio - Bevestiging lijstwerk - Tenderliist 	1	19x44	734
HS9	Screw for covering moulding - Schrauben für deckungsprofil - Vis de fixation profils horizontaux haut inférieur et extérieur d'encadrement de porte - Vite per cornice di copertura - Schroef voor afdekprofiel - Kruvi piirdelauale 	4	3.5x50	
HS12	Screw for covering moulding - Schrauben für deckungsprofil - Vis de fixation profils horizontaux haut inférieur et extérieur d'encadrement de porte - Vite per cornice di copertura - Schroef voor afdekprofiel - Kruvi piirdelauale 	50	4x40	
HS12	Screw for fascia boards - Schrauben für traufbretter - Vis pour fixation bandeau de toit - Viti x striscia del tetto - Schroef voor gevellijst - Kruvi räästalauale 	36	4x40	
HS12	Screw for roof edge reinforcement - Schrauben für dachrandverstärkung - Vis pour fixation corniere renfort de bord de toit - Viti x rinforzo bordo tetto - Schroef voor dakrand versterking - Kruvi räästatugevdusele 	20	4x40	
HS18	Screw for roof beams - Schrauben für dachbalken - Vis pour fixation pannes de toit - Viti per perline del tetto - Schroef voor gordingen / dakbalken - Kruvi pärlinitele 	6	5x120	
HS18	Screw for gable - Schrauben für giebel - Vis pour fixation des pignons - Viti per timpano - Schroef voor gevelpunt - Kruvi viilude kinnitamiseks 	6	5x120	
HS16	Screw for 1. wall beam - Schraube für 1. bohlenreihe - Vis de fixations 1ere rangée de madriers avec poutrelles de fondations - Vite fissaggio alle fondamenta - Schroef voor 1 wandbalk - Kruvi poolalauale 	9	5x90	

Pos	24.05.2022 Piece list - Stückliste - Liste des pièces - Elementi - Stuklijst - Tükítabel Art. Nr. 4428402 8/10	Q	P (mm)	L (mm)
HS16	Screw for foundation - Schrauben zur Befestigung Fundament - Vis de fixations des poutrelles de fondations - Viti x fondamenta - Schroef voor fundering - Kruvi alusraamile 	40	5x90	
SH44	Hammer block - Schlagholz - Calle de frappe - Blocco di legno da usare come cuscinetto quando si usa il martello - Slagklos - Löögiklots 	1		
SFS	Nut for storm protection - Schraubenmutter für Sturmleiste - Ecrou pour latte anti-tempete - Dado x asta protezione vento - Moer voor stromverankering - Mutter tormikinnitusliistule 	12	D8	
NF3	Zn nail for terrace - Zn Nägel für Terrassenbretter - Pointe pour plancher de terrasse - Chiodo zincato per terrazza - Spijker(nagel) voor terrasvloer - Nael terrassilauale 	530	2.1x50	
NF4	Zn nail for roof - Zn Nägel für Dachbretter - Pointe pour fixation voliges de toit - Chiodi x perline tetto - Spijker(nagel) voor dakhout - Nael katuselauale 	200	2x50	
NF5	Zn nail for roofing felt fillet - Zn Nägel für Dachpappenleiste - Pointe pour baguette de fixation feutre bitumeux - Chiodi x carta bituminosa x tetto - Spijker(nagel) voor asfaltpapier afdeklijst - Papiliistunael 	20	2x40	
BFS	Bolt for storm protection - Bolzen für Sturmleiste - Boulon pour latte anti-tempete - Bullone x asta protezione vento - Bout voor stormankerlat - Puidupolt tormikinnitusliistule 	12	8x80	
DFS	Washer for storm protection - Dichtscheibe für Sturmleiste - Rondelle pour latte anti-tempete - Rondella x asta protezione vento - Afdichtring voor storm strip - Seib tormikinnitusliistule 	12	D8	
VS	Ventilation screen - Belüftungsabdeckung - Couvercle d'aération Copertura di ventilazione - ventilatie deksel - ventilatsioonikate 	1		
	Window - Fenster - Fenetre - Finestra - Raam - Aken 540x540 AK.1.100.TPSP.a DGP+	1		
	Window - Fenster - Fenetre - Finestra - Raam - Aken 1010x1780 TAK.1.100.TPM0.e DGP+	1		
	Door - Tür - Porte - Deur - Uks 835x1957 UL.2.100.IVP.MMW TP+	1		
	<p>The Saunadoor is not included. It can be bought extra as 9906700 - Saunadoor</p> <p>Die saunatur ist nicht im hausset enthalten. Es kann als separates zuzatzpaket erworben werden 9906700 - Saunadoor</p> <p>La porte du sauna n'est pas incluse. Il peut etre achete en supplement comme 9906700 - Saunadoor</p> <p>La saunadoor non e inclusa. Puo essere acquistato extra come 9906700 - Saunadoor</p> <p>De saunadeur is niet inbegrepen. Het kan extra worden gekocht als 9906700 - Saunadoor</p> <p>Leiliruumi uks pole majakomplektis. Seda saab soetada eraldi lisapakina 9906700 - Saunadoor</p>			

Art. Nr. 4428402

01

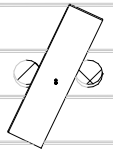

01

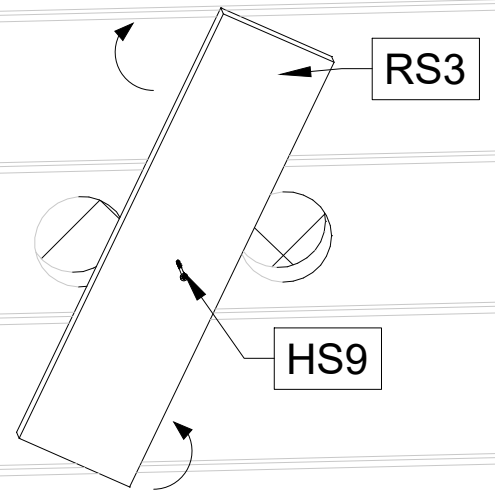

02

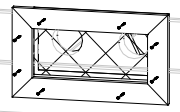

02

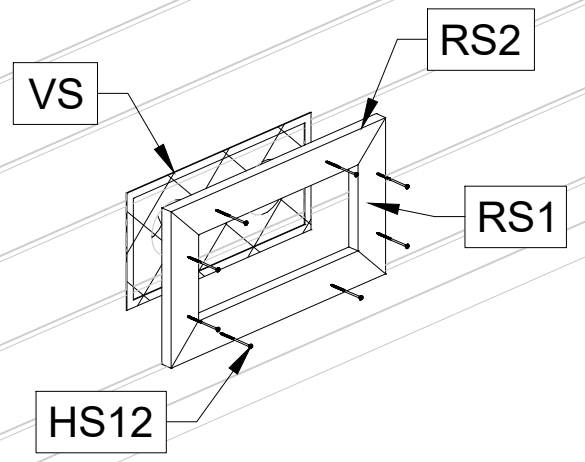

Art. Nr. 4428402



03

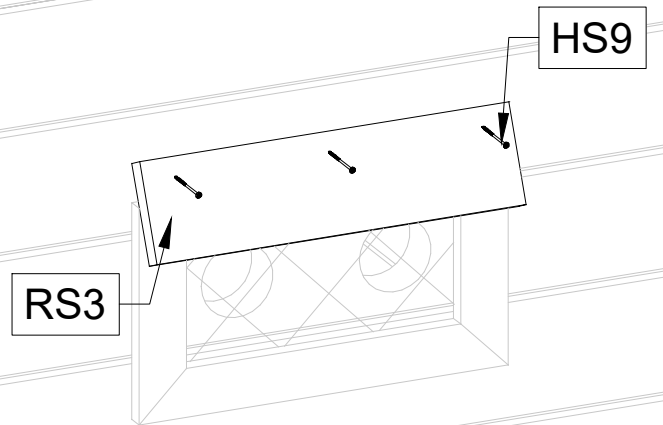

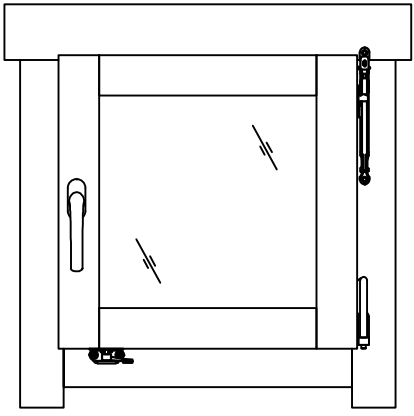
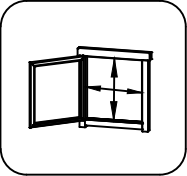
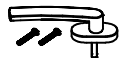



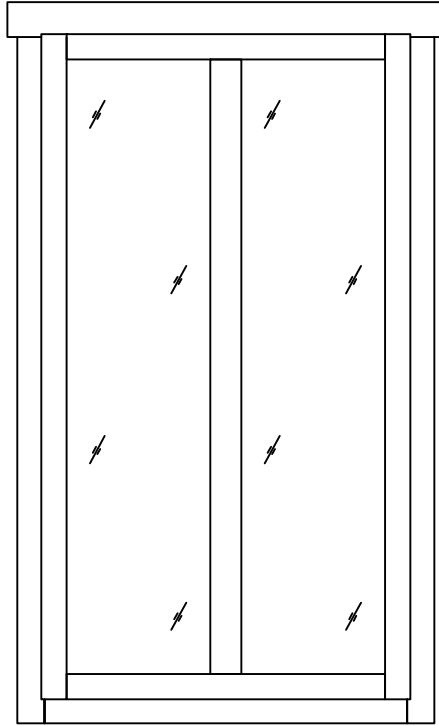

Pos	10.11.2017 Piece list - Stückliste - Liste des pièces - Elementi - Stuklijst - Tükítabel 540x540 AK.1.100.TPSP.a DGP+	1/1	Q	P (mm)	L (mm)
	<p data-bbox="263 152 1284 183">Glass size - Glasgröße - Taille de la vitre - Misura del vetro - Glas afmeting - Klaasi mõõt: 370x362 mm</p>   <p data-bbox="1364 347 1492 380">440x444 mm</p>				
FS2	<p data-bbox="263 2128 1021 2184">Window handle fittings - Fenstergriff - Poignee de fenetre - Maniglia c/ferramenta - Raamhendel -/grendel -/klink - Aknalink</p>		1		

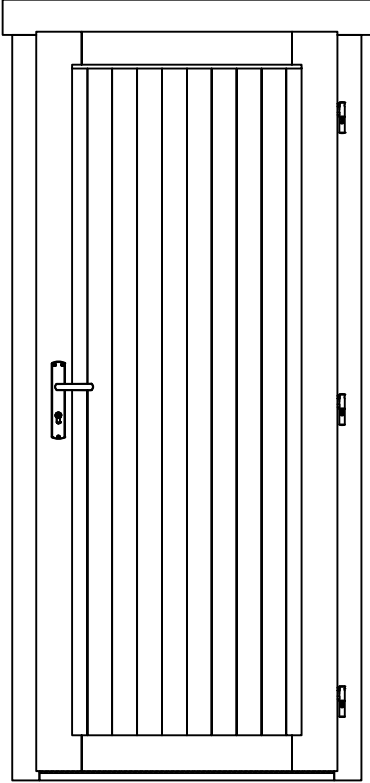
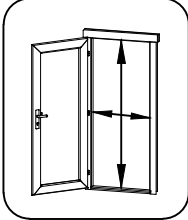
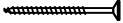
Pos	10.11.2017 Piece list - Stückliste - Liste des pièces - Elementi - Stuklijst - Tükitalabel 1010x1780 TAK.1.100.TPM0.e DGP+	1/1	Q	P (mm)	L (mm)
-----	---	-----	---	-----------	-----------

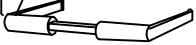
Glass size - Glasgröße - Taille de la vitre - Misura del vetro - Glas afmeting - Klaasi mõõt: 390x1602 mm

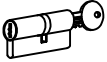

Pos	28.10.2016	Piece list - Stückliste - Liste des pièces - Elementi - Stuklijst - Tükítabel 835x1957 UL.2.100.IVP.MMW TP+	1/1	Q	P (mm)	L (mm)
						
						 735 x 1873 mm
HS16	Screw for door jamb - Schraube für türrahmen - Vis de fixation partie haute avec montants du cadre de porte - Viti x fissaggio montanti porte - Schroef voor deurkozijn - Kruvi ukse lengile		4	5x90		
HS25	Screw for doorstep - Schrauben für swelle - Vis pour fixation barre de seuil - Vite per soglia della porta - Schroef voor deurdorpel - Kruvi lävepakule		2	4.5x65		
MH	Male bolt hinge for door - Türband - Partie male de paumelle de porte - Cerniera anube x porta - Scharnier bout - Reguleeritav polthing isane		3	14x80		
TL4	Door handle fittings - Türgriff - Poignée de porte - Maniglie - Deurhendel klink - Ukse käepide		1			
TL5	Set of door lock covers - Schlossblenden - Set de garnitures de porte - Copertura serrature - Slot sluitplaat set - Ukse lukuplaat		1			
	Cylinder lock - Zylinderschloss - Barillet de porte - Serratura - Cylinder slot - Ukse lukusüdamik		1	30x35		
HC	Covers for door hinges - Schutzkappe für türband - Couverture de paumelle de porte - Copertura delle cerniere della porta - Afdek kap voor deurscharnier - Reguleeritava polthinge kate		6			

Pos

23.05.2022 Piece list - Stückliste - Liste des pièces - Elementi - Stuklijst - Tükitabel
9906700 - Saunadoor

1/1

Q

P
(mm)

L
(mm)

Glass size - Glasgröße - Taille de la vitre - Misura del vetro - Glas afmeting - Klaasi mõõt: 620x1854 mm

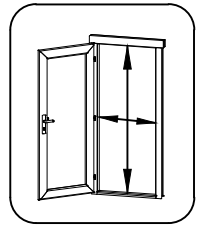

625x1860 mm

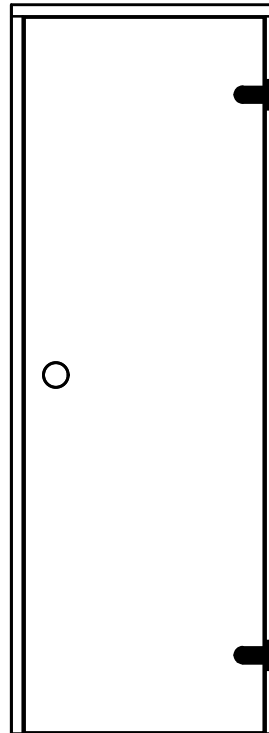

01

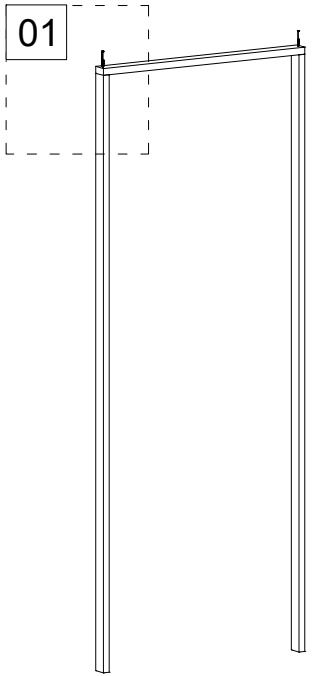

Art. Nr. 9906700

01

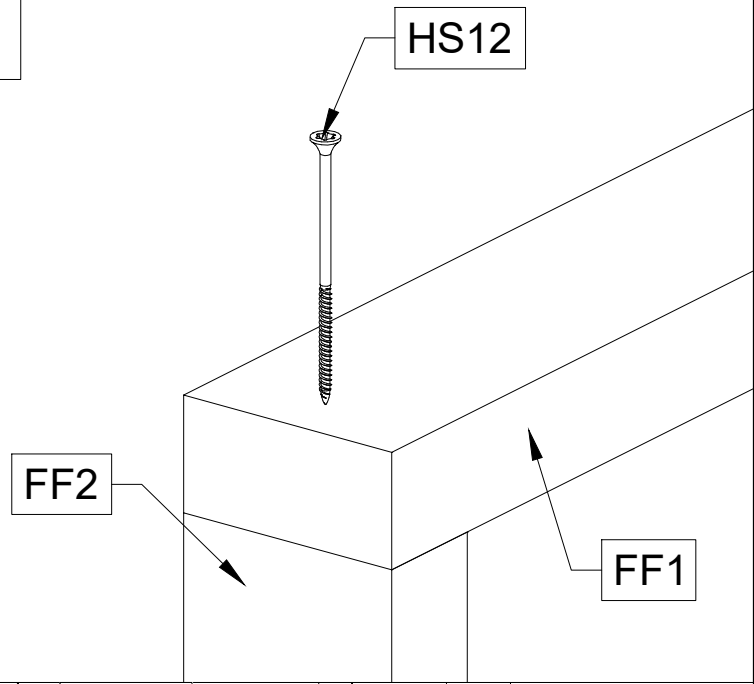

02

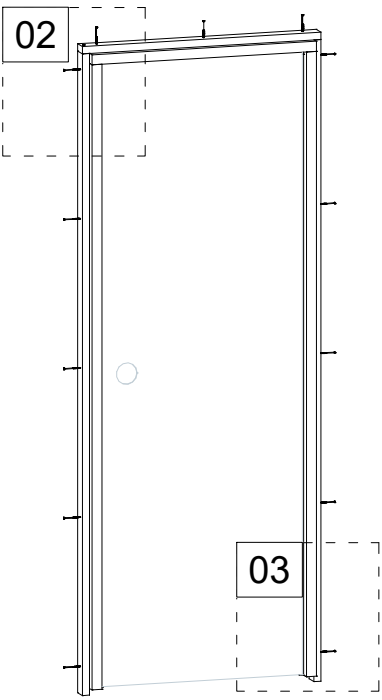

02

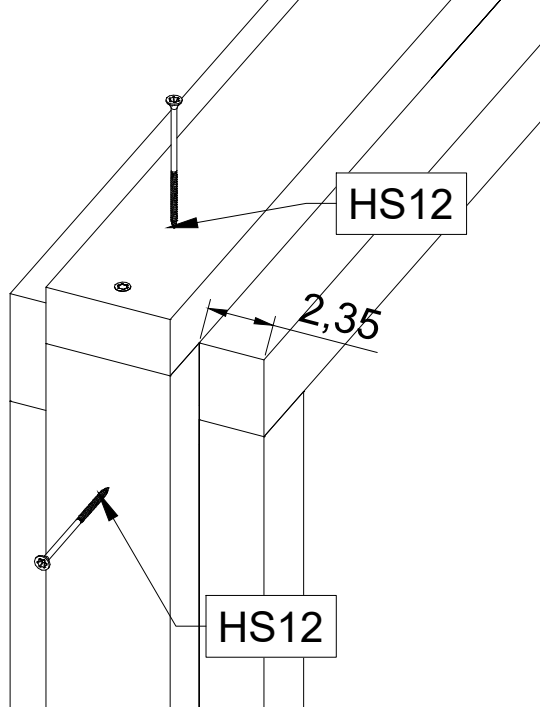

03

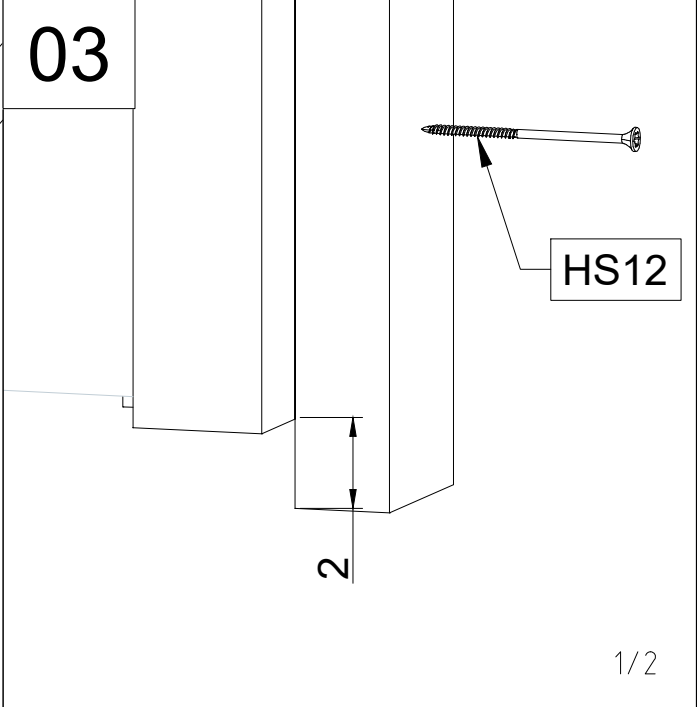

Art. Nr. 9906700

04

04

FF3

HS12

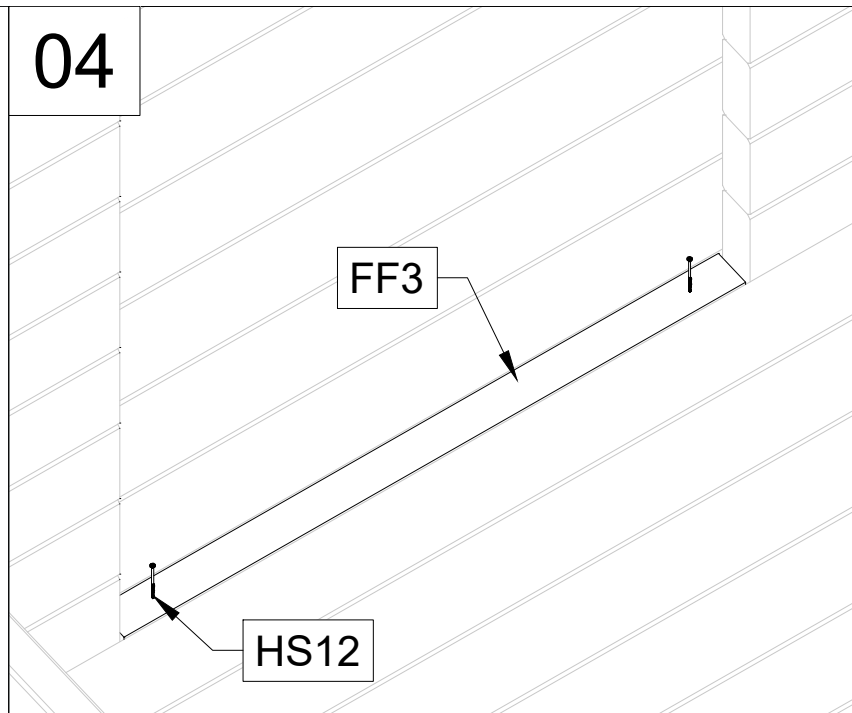
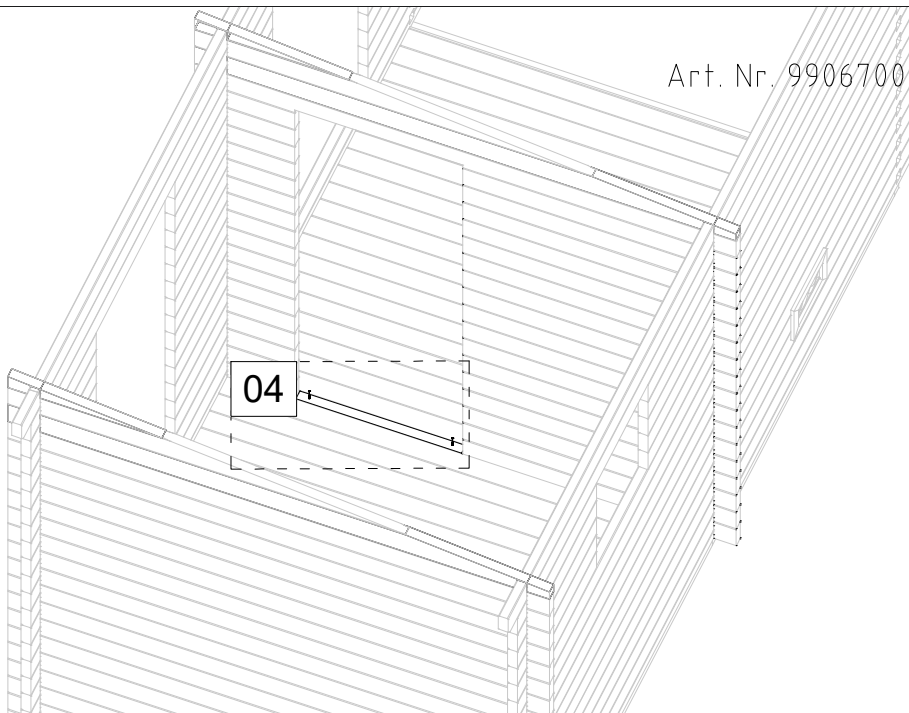

05

06

05

DL1

HS12

DL2

06

DL2

HS12

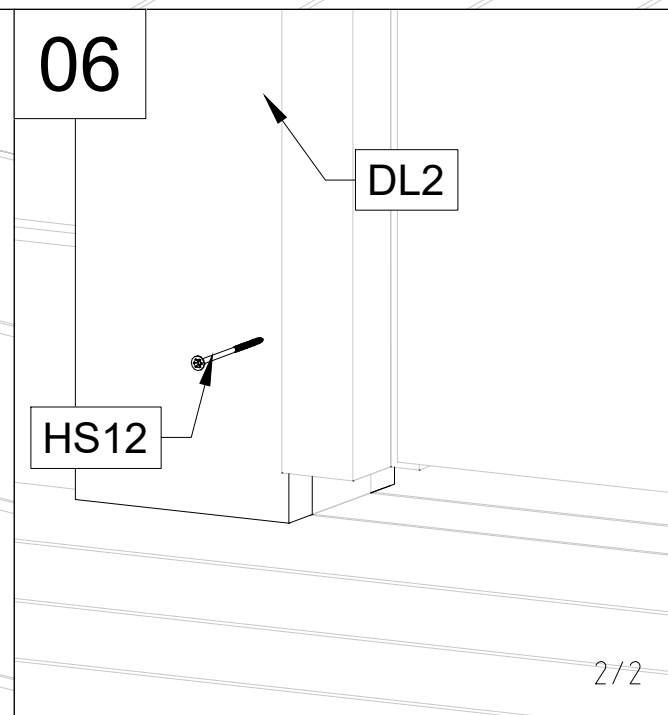
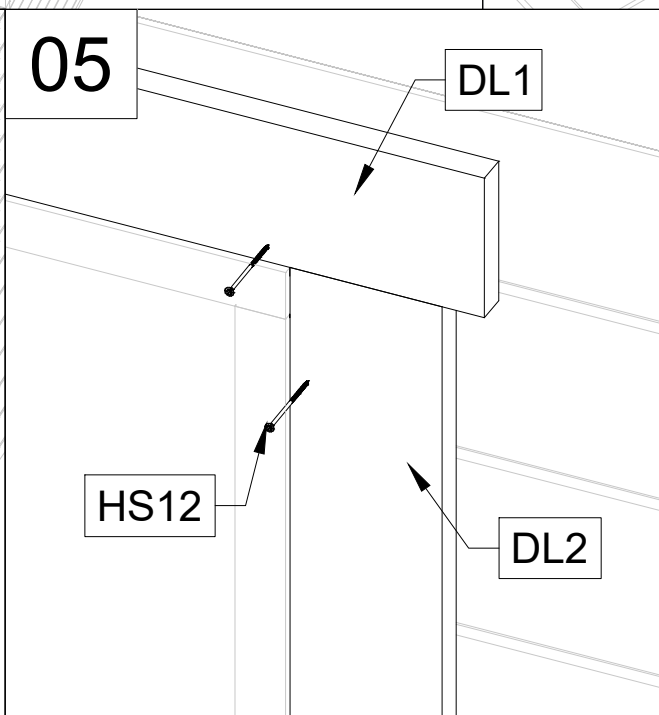
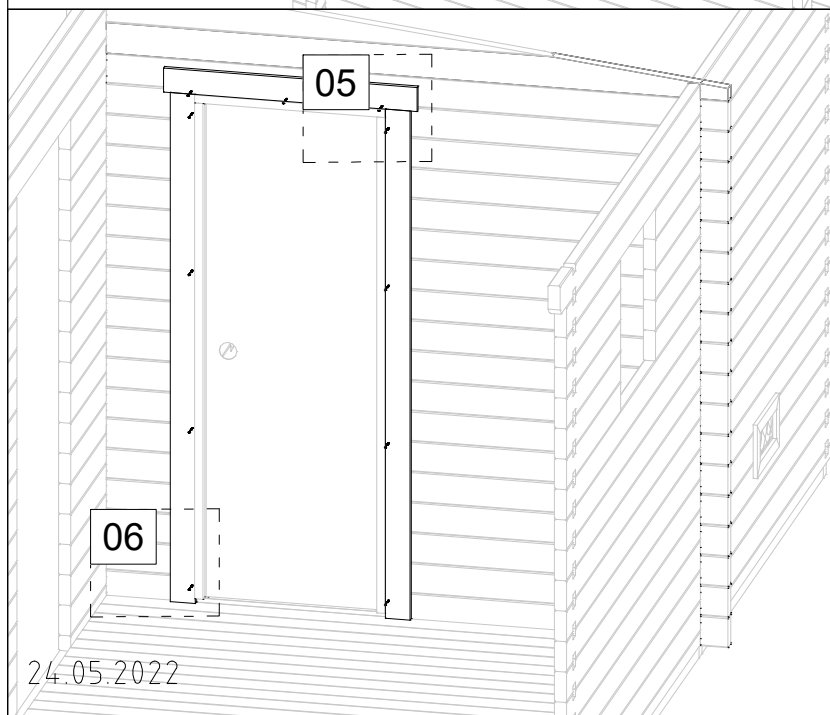

EN PLEASE NOTE!**PLEASE HANDLE THE DOOR VERY CAREFULLY!****TEMPERED GLASS MAY BREAK INTO SMALL PIECES IF CORNER OR EDGE HIT THE HARD SURFACE!**

- Installation requires two person.
- Please wear the eye protection and protective gloves during the installation.
- Before installation place the carton package or planks on the floor, on top of which the glass can be temporarily placed.
- We recommend to keep the transportation slat under the door in it's place until the installation process is finished.
- If You have to store the door in it's carton packaging, store it horizontally.
- Check the product before the installation. It is not allowed to install faulty or damaged goods.

MAINTENANCE OF THE DOOR

- Before the first use of the sauna we recommend to treat the wooden frame with sauna protection liquid (Tikkurila Supi for example).
- Check the fastenings of the roller-lock and hinges regularly. Fasten hinge bolts and regulate the lock if necessary.
- Avoid direct flow of water to the wooden door frame.
- Clean the door glass regularly using special glass cleaner. Try to avoid abrasive cleaners, which may damage the glass surface.

FI HUOM!**OLE VAROVAINEN LASIOVEN KÄSITTELYSSÄ JA ASENNUKSESSA!****KARKAISTU LASI SAATTAA HAJOTA JOUTUESSAAN KOSKETUKSIIN KOVAN PINNAN KANSSA.**

- Asentamiseen tarvitaan kaksi henkilöä.
- Käytä asennustyössä suojalaseja ja -käsineitä.
- Tee ennen asentamisen aloittamista lattialle työtaso, jonka päälle voit lasioven tilapäisesti laittaa. Käytä työtasona oven pakkausmateriaaleja tai
- Älä poista kuljetuslistaa oven alta ennen asennustyön päättymistä.
- Jos saunanovi siirretään varastoon, paketti on varastoitava vaakatasossa.
- Tarkista tuotteen laatu ennen asennuksen aloittamista. Vaurioitunutta tai virheellistä tuotetta ei saa asentaa.

OVEN HUOLTO

- Käsittele oven puupinnat ennen saunan käyttöönottoa puun pintakäsittelyaineella (mm. Tikkurilan Supi Saunasuoja).
- Tarkasta rulla-lukon ja saranoiden kiinnityksien kunto säännöllisesti. Kiristä tarvittaessa saranoiden kiinnityspultteja tai säädä lukitusta.
- Vältä suoraa vesikosketusta ovikehikkoon ja ylimääräistä kosteutta.
- Puhdista ovenlasi säännöllisesti lasinpuhdistusaineella. Vältä hankaavien puhdistusaineiden käyttöä, ne saattavat naarmuttaa lasin pintaa.

SE OBS!**HANTERA DÖRREN FÖRSIKTIGT!****HÄRDAT GLAS KAN SPLITTRAS I SMÅ BITAR OM EN KANT ELLER ETT HÖRN STÖTER MOT EN HÅRD YTA!**

- Monteringen bör utföras av två personer.
- Använd skyddsglasögon och -handskar vid montering.
- Innan monteringen påbörjas, lägg pappförpackningen eller några brädor på golvet så att dörren tillfälligt kan placeras på dem.
- Vi rekommenderar att låta transportlisten sitta kvar under dörren tills monteringen är klar.
- Ställ dörren horisontellt om den behöver förvaras i dess förpackning.
- Kontrollera produkten innan den monteras. En defekt eller skadad produkt får inte installeras.

SKÖTSEL

- Vi rekommenderar att behandla dörrkarmen av trä med ett bastuskydd (t ex Tikkurila Supi) innan bastun används för första gången.
- Kontrollera infästningen av rullås och gångjärn regelbundet. Dra åt gångjärnsbultarna och justera låset vid behov.
- Undvik vattenstänk direkt på dörrkarmen!
- Rengör dörrglaset regelbundet med glasrengöringsmedel. Använd inga slipande rengöringsmedel som kan skada glasytan.

HANDLE INSTALLATION / OVIVETIMEN ASENNUS / MONTERING AV HANDTAGET

Handle type is written on the label of the door package.

Vedintyyppi on ilmoitettu pakkauksessa olevassa tuotetarrassa.

Den aktuella typen av handtag anges på dörrpaketets etikett.

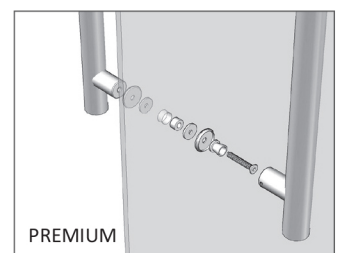
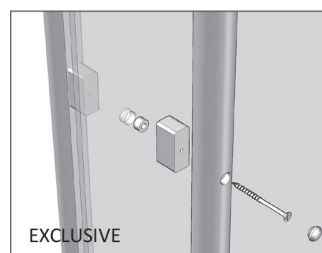
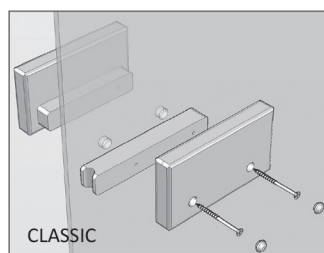
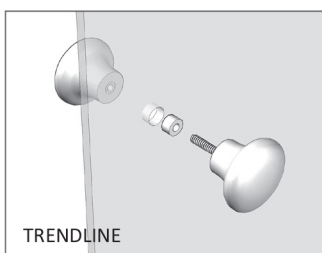

EN INSTALLATION PROCEDURE

1. Set the door up in a horizontal position on a flat base and open the package.
2. If it is necessary to change the opening direction, move the top rail to the other end (unscrew the four screws) and turn the door 180°. ①
3. Remove the plastic covers (1) from the hinges. Loosen the hexagonal screws (2) and remove the glass from the frame. ②
4. Place the door frame into the wall opening using screws (e.g. 5x80, not included in package) and tighten the gap with fire proof building foam or wool.
5. Install the glass by tightening the hexagonal screws (2) of hinges. ②
6. Check if the glass opens and closes freely and the gap between glass and frame is equal. Regulate the frame screws or adjust the hinges if necessary.
7. Attach the handle in position (see pictures on the other side of the page)
8. For making the door move easily, regulate the roller-lock. Be sure that the door can be opened smoothly and the glass is not closed too tightly. ③
9. Install the hinge plastic covers and wooden covers of frame fasteners.
10. Install the door mouldings (not included in package).

HINGE ADJUSTMENT

1. The maximum hinge adjustment range is 5 mm. You need 3 mm and 5 mm hexagon keys (not included in set). ②
2. Remove the plastic covers from the hinges (1).
2. Loosen the fixing screws of the glass (2) with a hexagon key (3) by no more than one revolution (not removing the glass).
3. To move the glass to left and right direction, turn the hexagon screws (4 and 5) by the necessary amount. If one screw is turned clockwise, then other should be turned anti-clockwise. Both screws should remain tighten.
4. Tighten the fixing screws of the glass (2).
5. Install the plastic covers (1) back to the position.

FI TYÖVAIHEET

1. Laita ovi vaakasentoon työtasolle ja avaa pakkaus.
2. Oven kätsyyttä voidaan muuttaa vaihtamalla vaakatason kehikonosan sijainti (poista neljä ruuvia) ja käännä ovea 180°. ①
3. Poista saranosta muovisuojuukset (1). Löysää pultit (2) ja irrota lasi ovikehikosta. ②
4. Asenna ovikehikko seinäaukkoon, kiinnitä ruuveilla (esim. 5x80, eivät kuulu toimitukseen) ja tiivistä rako palonkestävällä rakennusvaahdolla tai villalla.
5. Asenna ovi kehikkoon ja kiristä pultit (2). ②
6. Tarkista lasin esteetön avautuminen ja sulkeutuminen ja varmista, että lasin ja kehikon välinen rako oli koko pituudeltaan tasaisen leveä. Tarvittaessa säädä kehikon kiinnitysruuveja tai saranoita.
7. Kiinnitä puuvedin (katso kuvat seuraavalla sivulla).
8. Jotta ovi liikkuisi kevyesti, säädä rullalukitusta. Varmista, että ovi avautuu kevyesti ja lasi ei lukittuisi liian lujasti. ③
9. Asenna saranoihin muovisuojuukset ja kehikkoruuveihin puutulpat.
10. Asenna ovilistat paikoilleen (eivät kuulu toimitukseen).

SARANOIDEN SÄÄTÖ

1. Asennukseen käytetään kuusiokoloavaimia (3 mm ja 5 mm, eivät kuulu toimitukseen). ②
2. Poista saranoiden muovisuojuukset.
2. Löysää lasin kiinnitysruuvia (2) kuusiokoloavaimella (3) enintään yhden kierroksen verran (älä poista lasia).
3. Jotta lasia voisi siirtää vasemmalle tai oikealle, löysää ruuveja (4 ja 5) hieman. Jos toista ruuvia löysätään myötäpäivään, toista on löysättävä vastapäivään. Varmista, että ruuvit ovat vielä riittävän kireällä.
4. Kiristä lasin kiinnitysruuvi (2).
5. Laita saranoiden muovisuojuus takaisin paikoilleen.

SE ARBETSGÅNG

1. Lägg dörren horisontellt på plant underlag och öppna förpackningen.
2. Om dörrens upphängning behöver ändras, flytta karmöverstycket till andra änden (lossa de fyra skruvarna) och vänd dörren 180°. ①
3. Ta bort dekorlocken i plast (1) från gångjärnen. Lossa sexkantsskruvarna (2) och ta ut glaset ur karmen. ②
4. Montera in dörrkarmen i väggöppningen med hjälp av skruvar (t ex 5x80, medföljer ej) och täta fogen med ett brandbeständigt byggsaum eller isolerull.
5. Montera glasdelen genom att dra åt sexkantsskruvarna (2) av gångjärnen. ②
6. Kontrollera att glasdelen kan öppnas och stängas fritt och att spalten mellan glasdelen och karmen är jämn. Justera karmskruvarna eller gångjärnen vid behov.
7. Montera handtaget (var god vänd för att se bilder).
8. Justera rullåset så att dörren går lätt att öppna och stänga. Se till att dörren kan öppnas smidigt och att glasdelen inte stängs för hårt. ③
9. Sätt dekorlocken i plast på gångjärnen och träpluggarna över skruvhålen på karmen.
10. Montera dörrfoder (medföljer ej).

JUSTERING AV GÅNGJÄRN

1. Maximal justeringsmån är 5 mm. Du behöver 3 mm och 5 mm insexnycklar (medföljer ej). ②
2. Ta bort dekorlocken (1) från gångjärnen.
2. Lossa glasdelens fästskruvar (2) med hjälp av en insexnyckel (3), vrid högst ett varv (så att glasdelen inte lossnar).
3. Justera glaset åt vänster eller åt höger genom att vrida på sexkantsskruvarna (4 och 5) efter behov. Om ena skruven vrids medurs bör den andra skruven vridas moturs. Skruvarna får inte lossna.
4. Dra åt glasdelens fästskruvar (2).

