

*Art. Nr. 4019400*

*1/6*



12.03.2018

Art.Nr 4019400

Groundplan - Grundplan - Plan de masse - Planimetria - Plattegrond - Põhiplaan

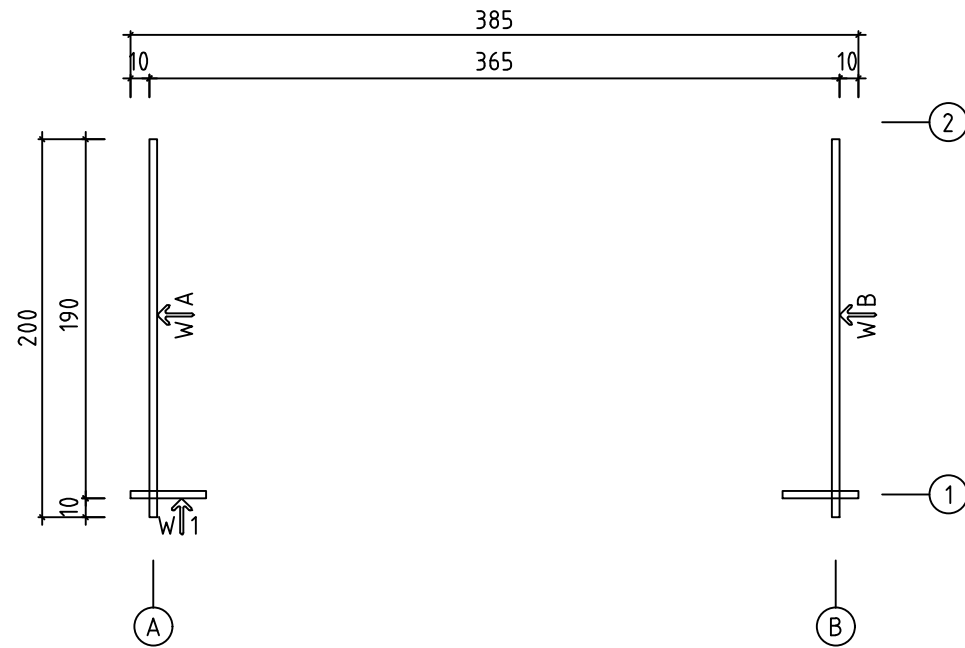

Foundation - Fundament - Fondation -  
Fondamenta -Fundering - Immutatud alusraam

Terrace boards - Terrassenbretter - Plancher de terrasse -  
Piattaforme terrazzo - Terrasvloer - Terrassilaudis

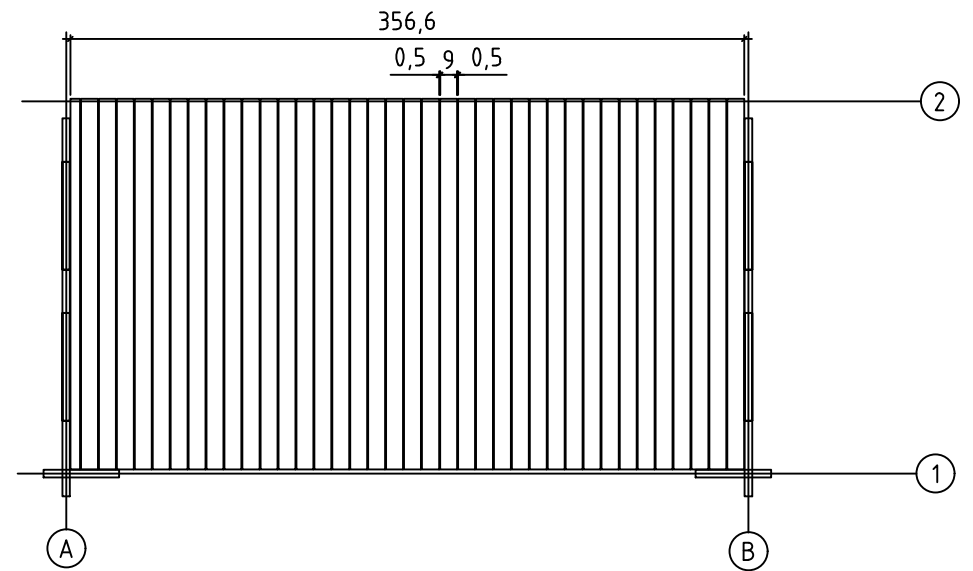
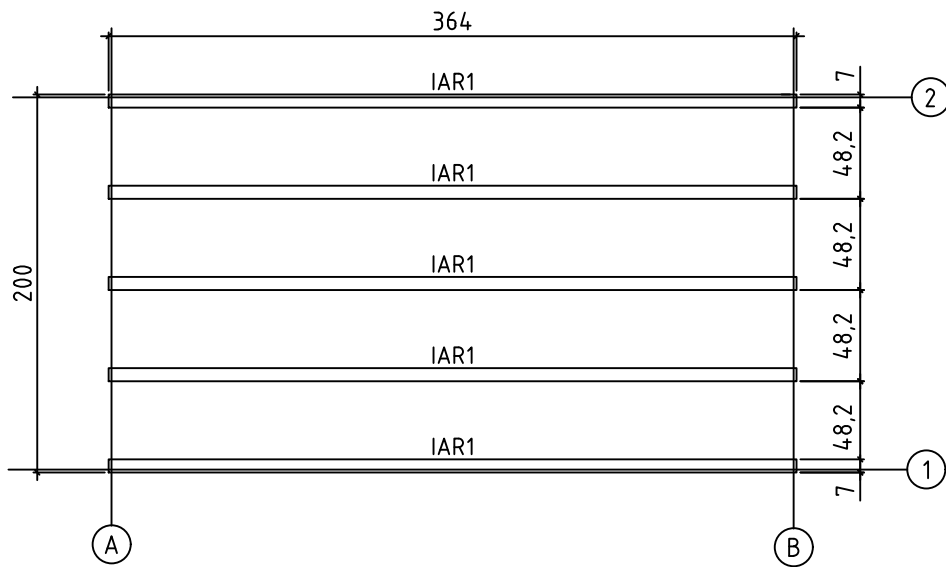



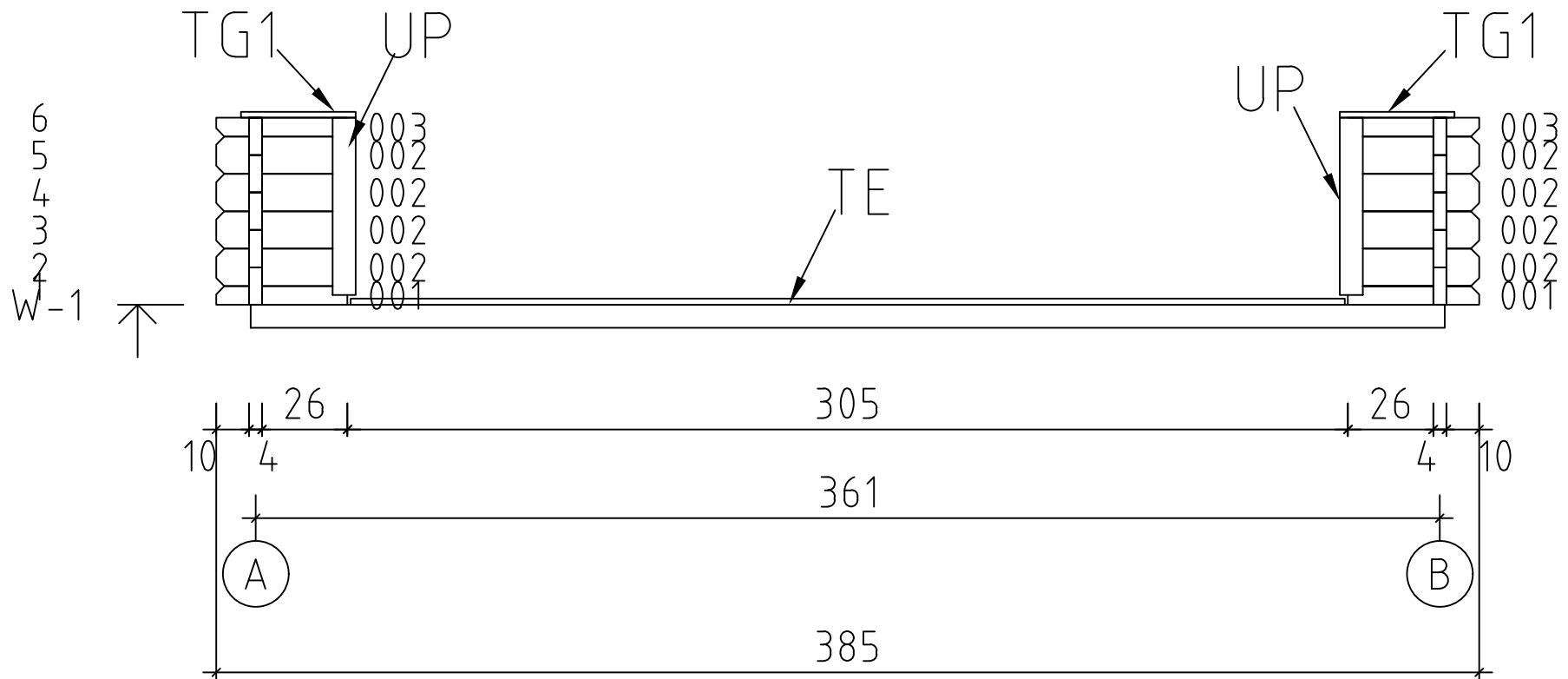



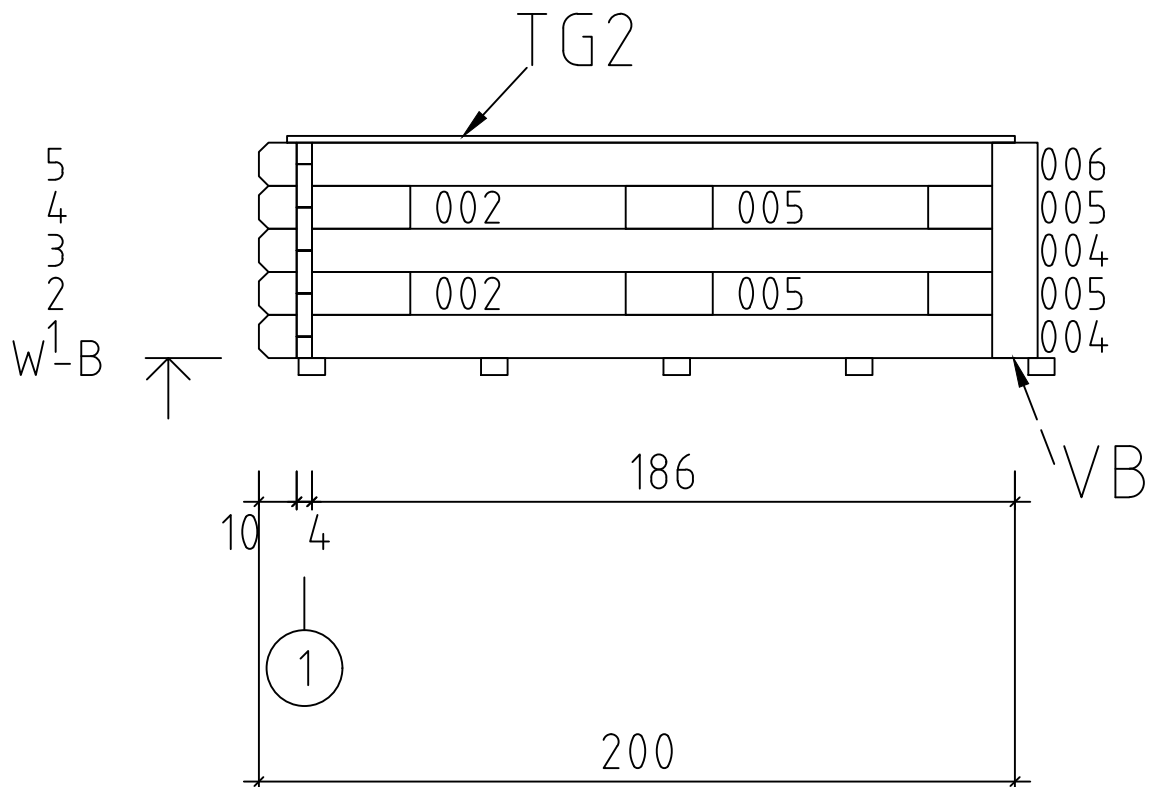
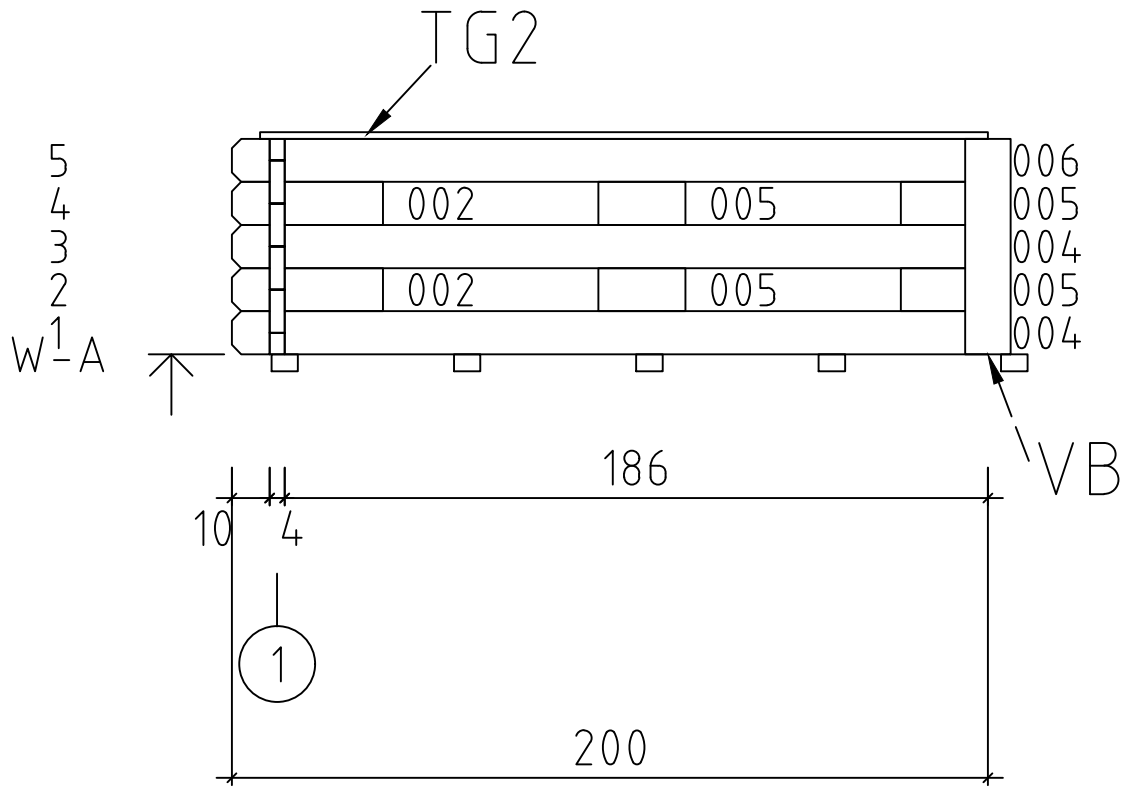



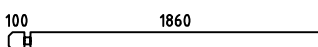

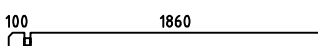

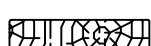

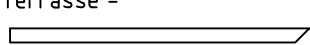
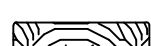
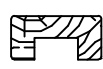
Art.Nr 4019400



Art.Nr 4019400



Pos	Piece list - Stückliste - Liste des pièces - Elementi - Stuklijst - Tükitalabel 12.03.2018 Art.Nr 4019400	6/6	Q	P (mm)	L (mm)
001			2	40x57	400
002			12	40x114	400
003			2	40x57	400
004			4	40x114	2000
005			8	40x114	230
006			2	40x114	2000
IAR1	Foundation - Fundament - Fondation - Fondamenta - Fundering - Immutatud alusraam 		5	70x45	3640
	Terrace boards - Terrassenbretter - Plancher de terrasse - Piattaforme terrazzo - Terrasvloer - Terrasilaud 		38	90x19	1961
TE	Terrace edge board - Terrassenbrett, eingang - Lamé de seuil d'entree de terrasse - Terrazzo uso abitacolo - Terrasvloer dorpel - Terrassi servaliist 		1	19x40	3030
TG1	Guard-rail for terrace - Terrassengeländer - Main courante de terrasse - Guardrail per terrazzo - Terras leuning - Terrassi äärelaud 		2	18x90	350
TG2	Guard-rail for terrace - Terrassengeländer - Main courante de terrasse - Guardrail per terrazzo - Terras leuning - Terrassi äärelaud 		2	18x90	1925
VB	Terrace joint boards - Verbindungsbrett - Profil de jonction pour fixer la terrasse au mur - Assi del terrazzo che compongono il pavimento - Terras verbindingsplank - Terrassi ühenduslaud 		4	18x120	570
UP	U-profile - U-profils - Profile u - Profilo ad u - U-profiel - U-profiil 		2	35x70	540
HS9	Screw for u-profile - Schraube zur befestigung u-profils - Vis a tete fraisée pour profil u - Vite per profilo ad u - Schroef ter bevestiging u-profiel - Kruvi U-profiilile 		4	3.5x50	
HS9	Screw for terrace joint boards - Schrauben für verbindungsbrett - Vis de fixation profil de jonction terrasse - Vite per unire delle assi del terrazzo - Schroef voor bevestigen verbindingshout - Kruvi terrassi ühenduseks seinaga 		20	3.5x50	
HS12	Screw for terrace rear boards - Schrauben für terrassenrand - Vis de fixation pour main courante de terrasse - Vite per il piano posteriore della terrazza - Schroef voor terras afsluitplint (achterzijde) - Kruvi terrassi äärelauale 		16	4x40	
HS18	Screw for foundation - Schrauben zur befestigung fundament - Vis de fixations des poutrelles de fondations - Viti x fondamenta - Schroef voor fundering - Kruvi alusraamile 		3	5x120	
HS16	Screw for 1. wall beam - Schraube für 1. bohlenreihe - Vis de fixations 1ere rangée de madriers avec poutrelles de fondations - Vite fissaggio alle fondamenta - Schroef voor 1 wandbalk - Kruvi poollauale 		4	5x90	
HS22	Screw for wall details - Schraube für wand details - Vis pour mur details - Viti per elementi della porta - Schroef voor wand details - Kruvi seinadetailile 		4	6x150	
NF3	Nail for terrace edge board - Nägel für terrassenbrett - Clou de fixation de lamé de seuil d'entree de terrasse - Chiodi per unire delle assi del terrazzo - Spijker(nagel) voor terrashout - Nael terrassi servaliistule 		9	2.1x50	
NF3	Zn nail for terrace - Zn nägel für terrassenbretter - Pointe pour plancher de terrasse - Chiodo zincato per terrazza - Spijker(nagel) voor terrasvloer - Nael terrasilauale 		380	2.1x50	